

Report on safety inspection cycle of outdoor storage tank facilities

By investigation committee

December, 2010

Ministry of Public Management, Home Affairs Posts and Telecommunications
Fire and Disaster Management Agency

Investigation committee for safety inspection cycle of outdoor storage tank facilities

Report Contents

Chapter 1 Outline of investigation examination

- 1.1 Object of investigation examination
- 1.2 Investigation matter
- 1.3 Investigation examination organization
- 1.4 Investigation examination process
- 1.5 Outline of examination for Investigation matter

Chapter 2 Analysis of present state

- 2.1 Present state of safety inspection
- 2.2 Resent state of outdoor storage tank facilities
- 2.3 State of accident occurrence
- 2.4 Internal inspection of bottom of tank
- 2.5 Back side corrosion of bottom of tank
- 2.6 Factor analysis of accident of outdoor storage tank facilities
- 2.7 Comparison with overseas outdoor storage tank facilities

Chapter 3 Assessment in case of internal inspection cycle extension

- 3.1 Assessment of inspection cycle extension (inside corrosion)
- 3.2 Assessment of inspection cycle extension (back side corrosion)
- 3.3 Assessment of inspection cycle extension (seismic performance)
- 3.4 Assessment of inspection cycle extension (defect in weld)
- 3.5 Assessment of inspection cycle extension summary

Chapter 4 Ideal way of safety inspection cycle making use of continuous plate thickness metrology

- 4.1 Evaluation of continuous plate thickness measurement technique
- 4.2 How to determine safety inspection cycle making use of continuous plate thickness metrology
- 4.3 Idea of calculation of inspection cycle

Chapter 5 The life of inside protection coating

- 5.1 Past result of review and examination method this fiscal year of the life of coating

- 5.2 Temperature inclination immersion examination of test piece glass flakes coated
- 5.3 Investigation of paint film deterioration situation in real tank
- 5.4 Coating passage years and analysis of repair history in real tank
- 5.5 Inside corrosion of tank where coating was constructed
- 5.6 Summary of temperature inclination immersion examination and tank paint film
Investigation
- 5.7 Examination of life of inside coating of outdoor storage tank

Chapter 6 Summary

Reference (Japanese only)

Chapter 1 Outline of investigation examination

.1.1 Purpose of investigation

The safety inspection of the outdoor tank storage facilities where dangerous articles of the liquid of 10,000 kiloliters or more in capacity is undergone by municipal head such as mayors for each of the eight years cycle (10 years or 13 years for the one that takes the measures for safety) under the fire protection law.

In the business sort of "Consignment expense of the national oil-stockpiling management etc." by the administrative reform conference that had been held on November 27, 2009, it was requested to search for the possibility of deregulation of the tank safety inspection interval in the fire protection law while verifying it enough. To do the investigation examination that lies at the cycle of the safety inspection of the outdoor tank facilities based on such a situation stated above, Investigation study Committee is set up.

1.2 Investigation consideration

1.2.1 Evaluation of safety when basic inspection cycle is extended

When the basic inspection cycle is extended, the evaluation of safety is executed from the view points of the situation of the occurrence of the accident, the factor analysis, and the possibility of the spill accident generation by the progress of corrosion and the earthquake performance reduction etc. All of the outdoor tank storage facilities at the national oil-stockpiling terminals are constructed after 1977 when a detailed technological standard for outdoor tank storage facilities was provided. As for the outdoor tank storage facilities installed after 1977, its safety is different from the ones set up before that. Therefore, items examined herein are for the outdoor tank storage facilities set up after 1977 as it is not technically appropriate to treat in the same way since the influence caused by the cycle extension is also different in both.

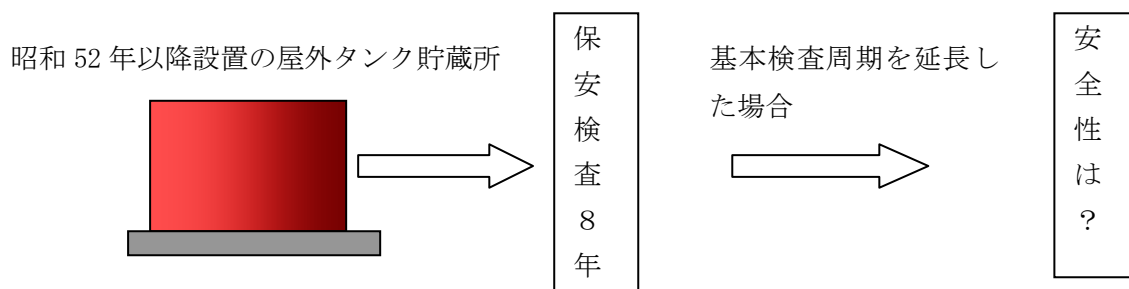

1.2.2 Ideal way at inspection cycle

The thickness management of the bottom plate using the equipment that efficiently measures it continuously has recently come to be executed though it was general so far that the thickness management of the bottom plate of the tank which is the main body of the outdoor tank storage facilities (Hereafter, it is said, "Tank") by the fixed point metrology (The measurement example by the fixed point metrology is shown in Figure 1.2.1) with an ultrasonic thickness meter. So, whether the safety inspection cycle can be decided to a specific individual outdoor tank storage facility is examined without decreasing safety by using the continuous board thickness metrology (The example of the measurement result is shown in Figure 1.2.2).

Within the main deterioration mechanism of Tank such as a decrease in plate thickness due to corrosion, deterioration in the weld and an uneven settlement of the base as described in 2.6, only a decrease in plate thickness due to corrosion can be able to confirm by the continuous plate thickness metrology. On the other hand, because both a concrete standard is not about the firmness of the base of the outdoor tank facilities and there is something with inferior reliability in the weld of Tank set up before 1977, safety cannot be examined with a deterioration mechanism by a decrease in plate thickness alone. By the reason above mentioned, the continuous board thickness metrology can examine the cycle of outdoor tank facilities (And, one to have the performance more than the equal to it) set up only after 1977. Therefore, this examination item is for these outdoor tank facilities.



図 1.2.1 タンクの底部板厚の定点測定の例



測定状況

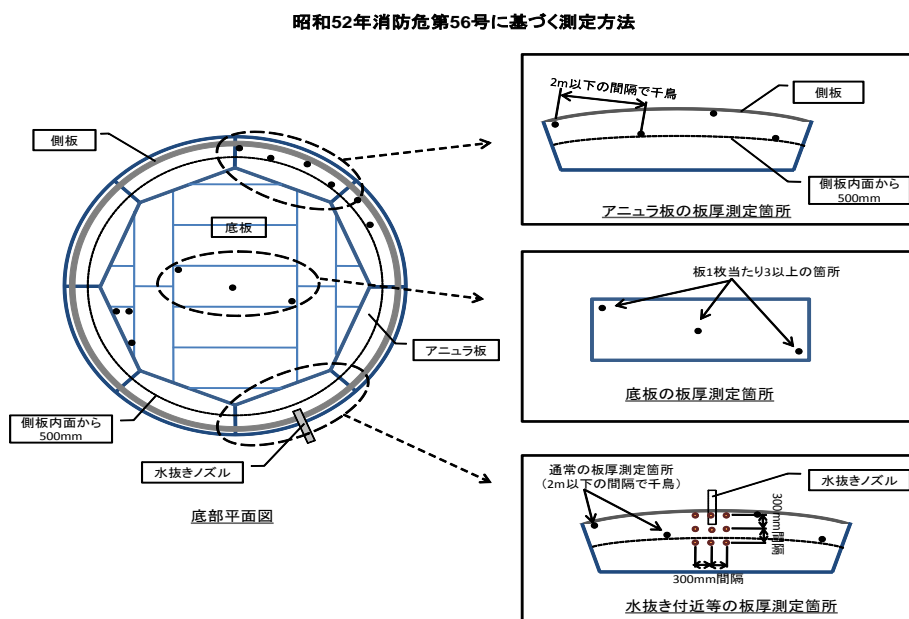
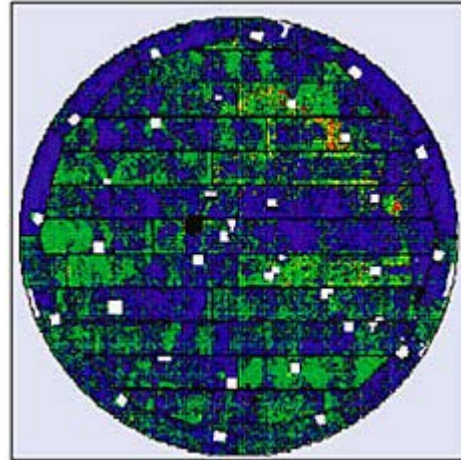

測定結果 青色分は元板厚の 90%以上の板厚の領域。緑色は 80~90%、黄色は 70~80%、赤色は 70%以下の領域

図 1.2.2 タンクの底部全面を連続板厚測定した例

1.2.3 The life of inside protection coating

An inside coating is one of the requirements as the measures for safety for 13 years, the longest cycle of the safety inspection of the outdoor tank storage facilities where dangerous articles of the liquid of 10,000 kiloliters or more in capacity are stored. The life of this inside coating is assumed to be 20 years ("Coating guide": fire fighting [abuna] No.74 on September 1, 1994). Since results data that it is used soundly exceeding this years are accumulated in recent years, whether the life of the coating can be extended without decreasing safety is examined. Figure 1.2.3 shows the image at the recoating time of the coating when the life can be extended.



図 1.2.3 コーティングの塗り替え時期のイメージ

The abbreviation used at this study committee is as follows.

- Fire protection law (No.186 of law in 1948) ··· Law
- Government ordinance concerning restriction of dangerous articles (No.306 of government ordinance in 1959) ··· Government ordinance
- Rule concerning restriction of dangerous articles (Prime Minister's Office [rei] No.55 in 1959) ··· Rule
- Notification (No.99 of Ministry of Home Affairs notification in 1974) that provides details of standard in technology concerning restriction of dangerous articles ··· Notification
- Main body of tank of outdoor storage tank facilities ··· Tank
- Specific outdoor tank facilities to which construction permit was applied after government ordinance concerning restriction of dangerous articles and government ordinance (No.10 of government ordinance in 1977) in which a part of fire fighting method enforcement order is revised are enforced ··· New law tank
- When the government ordinance concerning the restriction of dangerous articles and the government ordinance (No.10 of the government ordinance in 1977) in which a part of the fire fighting method enforcement order is revised are enforced, permission to lie set by regulations of steps is actually obtained in front of Article 11 clause 1 of the law. Or, what has not suited the standard in the technology that the structure and equipment provide in 2 or No.4 3 of the government ordinances in Article 11 clause 1 in a specific outdoor storage tank facilities where permission concerned was applied ··· The old law tank.
- The one that has not suited technological standard that the structure and equipment provide in clause 3 each title of government ordinance of the tenth additional clause in 1977 among old law tanks ··· Old law old standard tank
- The one that has suited technological standard that the structure and equipment provide in clause 3 each title of government ordinance of the tenth additional clause in 1977 among old law tanks ··· Old law new standard tank
- The one that has suited technological standard that the structure and equipment provide by administration ministerial ordinance first of government ordinances of the 214th additional clauses in clause 3 in 1994 among old law tanks ··· The first stage standard tank of old law

1.3 System of investigation examination

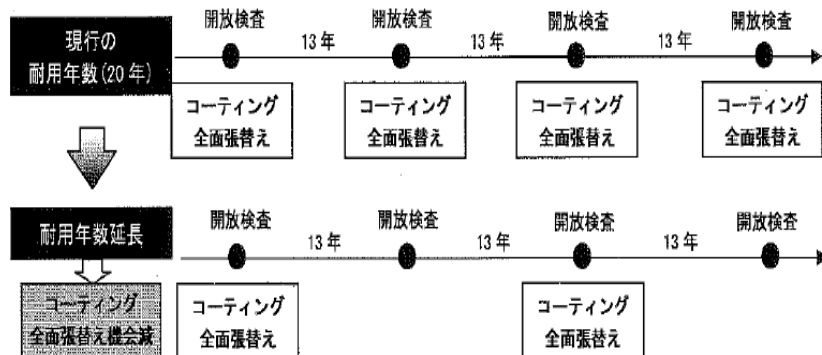
Investigation study committee of cycle of safety inspection of
outdoor storage tank facilities

(Japanese syllabary order, honorific title abbreviation)

Chairman

Asamichi Kamei; former special duty professor of education center of research for
science of safe and ease, Yokohama National University,

Member

Naotake Otsuka; professor of mechanical system engineering department at Ryukoku
University

Shinji Okazaki; Associate professor of function creation department, graduate school
engineering, Yokohama National University

Tomohiko Tsutida; Project Director of Petroleum Stockpile Management Department,
Planning & Management Division, Japan Oil, Gas and Metals
National Corporation

Masanori Mine; Deputy General Manager of Manufacturing Technology Division &
Engineering Department, Nippon Oil Corporation,

Tetsuo Miyamura; Professor of Department of Industrial Systems Engineering, Chuo
University,

Siniti Mori; Manager of Hazardous Materials Section Fire Prevention Department,
Kawasaki City Fire Bureau

Minoru Yamada; Head of Research & Development Division, National Research
Institute of Fire and Disaster

Working group for longevity of inside coating of outdoor storage tank

Chief

Minoru Yamada: Head of Research & Development Division, National Research Institute of Fire and Disaster

Member

Shinji Okazaki: Associate professor of function creation department, graduate school engineering, Yokohama National University

Susumu Ogawa: General manager, East Branch Office, Japan Paint Inspection and Testing Association,

Yasuhisa Kimura: Kashiwabara Corporation,

Kenji Kurosawa: NACE Certified Coating Inspector, Steel Structural & Architectural Coating Department, Dainippon Toryo Co. Ltd,

Tetsuo Miyamura: Professor of Department of Industrial Systems Engineering, Chuo University,

Kaniti Horii: Senior Engineer of Tank Engineering& Construction Department, Nitiyo Engineering Corporation,

You Yamamoto: Manager of Integrity Management Group, Maintenance & Engineering Department, Cosmo Oil Co. Ltd,

Akio Yokoyama: Special Member of Plastic Lining Association,

1.4 Investigation examination passage

The passage of the examination is as follows.

(1) Investigation study committee that lies at cycle of safety inspection of outdoor storage tank facilities

The first study committee April 23, 2010

The 2nd study committee June 24, 2010

The 4th study committee October 22, 2010,

The 3rd study committee August 23 2010

The 5th study committee December 16, 2010

(2) Working group concerning the life of inside coating of outdoor storage tank

The first study committee May 18, 2010

The 2nd study committee July 30, 2010

The 3rd study committee November 5, 2010

The 4th study committee November 26, 2010

1.5 Outline of examination of investigation consideration

(1) Information on the current state of the outdoor storage tank facilities, the situation of the occurrence of the accident, the influence of the dangerous article spill accident and the situation of overseas shut down inspection, etc. was collected and arranged. Moreover, data of the inspection and the repair situation, the cause report of the accident occurred in the past, the occurrence of corrosion and etc. were collected and analyzed to clarify the factor of the accident and the deterioration mechanism. As a result, a constant finding about the corrosion rate and its range of the bottom plate of Tank and etc. were obtained though there remained uncertainty since there is a constant number of case of which the bottom plate was removed without measuring its corrosion depth and because of the restriction of the data measurement density and frequency (Chapter 2).

(2) After constant assumption about the deterioration mechanism of the tank was put by using the data when it was inspected, how the possibility of the accident increase by the basic inspection cycle extension was evaluated quantitatively per each deterioration factor (Chapter 3).

(3) When the continuous plate thickness metrology was applied to the tank bottom plate, it was evaluated how a very detailed analysis was possible. Moreover, it was examined whether the inspection cycle was able to be extended without ruining safety, when the uncertainty to be included in the measurement and the presumption of a corrosion rate were evaluated. As a result it was proposed that constant years were enable to extend at Tank inspection cycle under the condition that the requirements such as the corrosion speed of back of bottom plate was less than a constant value when continuous plate thickness metrology was used and coating meeting certain conditions was applied and inside corrosion speed was very small because of contents having no causticity were fulfilled (Chapter 4).

(4) With respect to life of coating, the temperature inclination immersion examination result, site investigation data and the repair history data were collected and analyzed. As a result, the life of the glass flakes coating mostly used in the new law tank was evaluated as 26 years by meeting the condition that it has a constant film thickness by constructing under constant quality control and using the material for which the quality was secured (Chapter 5).

Chapter 2 Current state analysis

2.1 Current state of safety inspection

2.1.1. Safety inspection object and cycle

It is specified that owner or equal person of outdoor storage tank facilities of 10,000 kl in capacity of liquid dangerous article must undergo safety inspection (Hereafter, Safety Inspection) for a certain period by mayor of municipality about whether structure and equipment of concerned outdoor storage tank facilities are maintained in accordance with technology standard (Hereafter, Technology Standard)

[Four of government ordinance of Article 8-4, clauses 1] .

Moreover, Safety Inspection is applied in order to check if items shown below meet Technology Standard (clauses 3 and 6 of the government ordinance of Article 8-4).

- ・Matter concerning thickness of plate that lies to bottom of Tank
- ・Matter concerning weld that lies to bottom of Tank

A current safety inspection cycle (new law tank and the first stage standard tank of the old law) is indicated in Table 2.1.1.

表 2.1.1 新法及び旧法第一段階基準タンクに係る保安検査の周期

保安のための措置	周期	保安のための措置の内容
—	8年 (基本周期)	—
腐食防止等の状況の措置	10年	コーティングによる内面腐食防止、底部板厚が適正であること、共通する措置項目 ^{注)}
貯蔵管理等の状況の措置	10年	水等腐食成分の適切な管理がされていること、腐食性の危険物を貯蔵しないこと、貯蔵条件の変更がないこと、底部腐食率が小さいこと(0.05mm/年以下)、次回開放時の板厚推定値が適正であること、共通する措置項目 ^{注)}
腐食量に係る管理等の状況の措置	13年	コーティングによる内面腐食防止、次回開放時の板厚推定値が適正であること、底部腐食率が小さいこと(0.05mm/年以下)、加温貯蔵されないこと、基礎内部の水分を排出できる措置があること、共通する措置項目 ^{注)}

注) 基本周期以外の周期に係る共通する措置項目

- ・外面腐食防止措置が講じられていること
- ・構造上の影響をあたえるおそれのある補修又は変形がないこと
- ・不等沈下量が直径の300分の1以下(地層が水平成層である場合は100分の1以下)であること
- ・地盤沈下量が年間1cm以下であること
- ・維持管理体制が適切であること

2.1.2 Transition at safety inspection cycle

Figure 2.1.1 shows the transition of the safety inspection cycle.

(1) Foundation of Safety Inspection system (1977)

In the cause investigation report¹⁾ of the oil spill accident from the outdoor storage tank facilities in 1974, at Kurashiki City, Okayama, such necessity as securing of the main body of the firmness of the base and performance that the material of main body had to have and appropriate execution management of welding and nondestructive testing for the outdoor storage tank facilities was proposed. Thus, a technological standard concerning the base, the ground, and the main body of the outdoor storage tank facilities was strengthened greatly. The tank was opened every five years, and the system that a safety inspection and an internal check (voluntary inspection) were alternately executed was made.

(2) Provision for 8 years of a fundamental cycle of safety inspection and 10 years of the cycle of an individual extension (1994)²⁾

The rate of accident of the outdoor tank facilities decreases and uneven settlement generation decreases after 1977. Moreover, the result of every 10 years inside check for specific outdoor storage tank facilities of 10,000 kl in capacity and high corrosion protection performance of inside protection coating was confirmed. As a result, it was decided that fundamental cycle was 8 years and for facilities of which inside corrosion control measures and etc. were taken, 10 years cycle were allowed for new law tank and old law stage standard tank on the basis of the examination by owner, people from academic background and person related to fire fighting parties concerned.

In this case, it was on the mind that the outdoor storage tank facilities of 10,000 kl more in capacity was the one that it was put might cause the great deal of harm because the stress generated in shell is higher and capacity is bigger than those of facilities below 10,000 kl in capacity.



図 2.1.1 保安検査周期の改正経緯

(3) It provides for the cycle 13 years that lie the one that the corrosion amount management etc. are done (2003)3.)

The study committee by the owner of outdoor storage tank facilities, the people from academic background, and the person related to fire fighting concerned was held, and the results of the corrosion rate of the bottom of the new law tank were collected, and the corrosion factor was analyzed. As a result, the expression that presumes the maximum corrosion depth of an individual tank was proposed by capacity, the oil temperature, the tenure of use, the amount of the uneven settlement, the facing situation to the coast or the river and the preventive measure for rain water going into. When safety was secured for the deterioration factors other than the bottom plate corrosion, it was assumed that the cycle was able to be taken to be 13 years individually in a new law tank and the first stage standard tank of the old law.

2.2 Current status of outdoor storage tank facilities

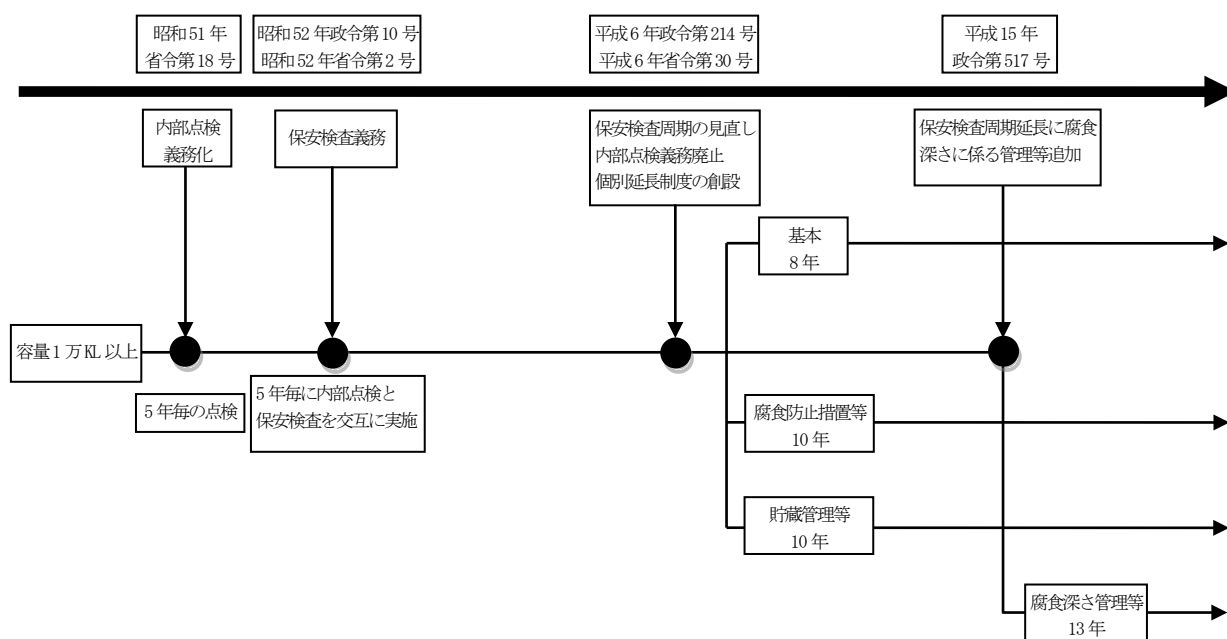
2.2.1 Repair situation in safety inspection

The details of the repair in case that the safety inspection was done for new law tanks between 2006 and 2008 fiscal year were examined. As shown in Table 2.2.1, the one without the repair at all was 0 or 1, and the repair was done in most one. The outline of the repair of these one was summarized in Tables 2.2.2 and 2.2.3. The annular plates that are the constructional important parts exposed to a severe distortion condition and at which a big stress was caused in the tank bottom were partially or as a whole substituted with about 6 to 13%. Moreover, the bottom plates were partially or as a whole changed with about 5 to 16%. Moreover, as for the repair of the weld, the whole line of two Tanks were repaired in last three years, and a partial repair was done with about 80 percent in the weld line between the shell and the annular plates where the highest stress was caused. The repair was done by 80 percent or more as for other parts. It was thought that safety until the next inspection was maintained by these repairs.

表 2.2.1 平成 18 年～20 年度保安検査時の補修概要

	保安検査 基数	取替・当て板	肉盛り補修	溶接部補修	補修がなかつた基数
平成 20 年度	79	19 (24%)	52 (66%)	75 (95%)	1 (1%)
平成 19 年度	69	10 (14%)	44 (64%)	67 (97%)	1 (1%)
平成 18 年度	60	7 (12%)	31 (52%)	60 (100%)	0 (0%)

注：補修内容が複数あるものは、当該内容をそれぞれ計上している。

表 2.2.2 底部板の補修概要

補修部位 年度		アニュラ板			底板			保安検査基数
		全取替	部分取替	当て板	全取替	部分取替	当て板	
平成 20 年度	基	3	7	0	5	8	2	79
	%	3.8	8.9	0.0	6.3	10.1	2.5	
平成 19 年度	基	2	2	0	1	4	3	69
	%	2.9	2.9	0.0	1.4	5.8	4.3	
平成 18 年度	基	0	4	1	0	3	3	60
	%	0.0	6.7	1.7	0.0	5.0	5.0	

表 2.2.3 底部溶接線の補修概要

補修部位 年度		アニュラ板タイプ								保安検査基数
		側板・アニュラ板 間溶接線		アニュラ板相互 間溶接線		アニュラ板・底板 間溶接線		底板相互 間溶接線		
		全線補修	部分補修	全線補修	部分補修	全線補修	部分補修	全線補修	部分補修	
平成 20 年度	基	1	63	0	68	0	62	0	72	79
	%	1.3	79.7	0.0	86.1	0.0	78.5	0.0	91.1	
平成 19 年度	基	0	51	0	49	0	50	0	59	69
	%	0.0	73.9	0.0	71.0	0.0	72.5	0.0	85.5	
平成 18 年度	基	1	50	0	50	0	50	0	60	60
	%	1.7	83.3	0.0	83.3	0.0	83.3	0.0	100	

注：補修内容が複数あるものは、当該内容をそれぞれ計上している。

2.2.2 Number of Tank at outdoor storage tank facilities according to installation permission year

Figure 2.2.1 shows the number of the new law Tank of 10,000 kl or more in capacity according to the installation permission year. The number of Tanks set up in the 1975's counts for 463 and is about 70 percent among 617 (Abolition is included) new law tanks understood in Fire Defense Agency, and 98 (only about 20 percent) of them were constructed in the Heisei era. Since the peak of the installation was in 1981, it is understood that many of new law tanks have passed about 30 years after set up.



図 2.2.1 容量1万キロリットル以上の新法タンクの設置許可年別基数

2.2.3 Repair situation when safety was inspected before one cycle

Many of new law tanks have passed about 30 years as described by 2.2.2 since set up, and it is important to understand the change in the repair situation according to the aged deterioration when safety was inspected. Then, the outline of the repair from 1998 to 2000 which roughly corresponds to that in one cycle before inspection shown in Table 2.2.1 was examined. As shown in Table 2.2.4, the repair was done in a lot of new law Tanks when safety was inspected. The figures shown in row in Table 2.2.5 are an average of three years (in Table 2.2.1 and Table 2.2.4), respectively. Thus, it is understood that the execution ratio of a meat vigor repair and a weld repair increased greatly in addition to the execution ratio of a large-scale repair such as substitution and application of patched plate comparatively rising as years increase since set up. The graph of Figure 2.2.2 shows the repair number of the bottom of Tank by the difference at the safety inspection time. It is understood that the aged deterioration of the new law tank advances and the execution ratio of repairing required has increased as passing of years since the installation.

表 2.2.4 平成10年～12年度保安検査時の補修概要

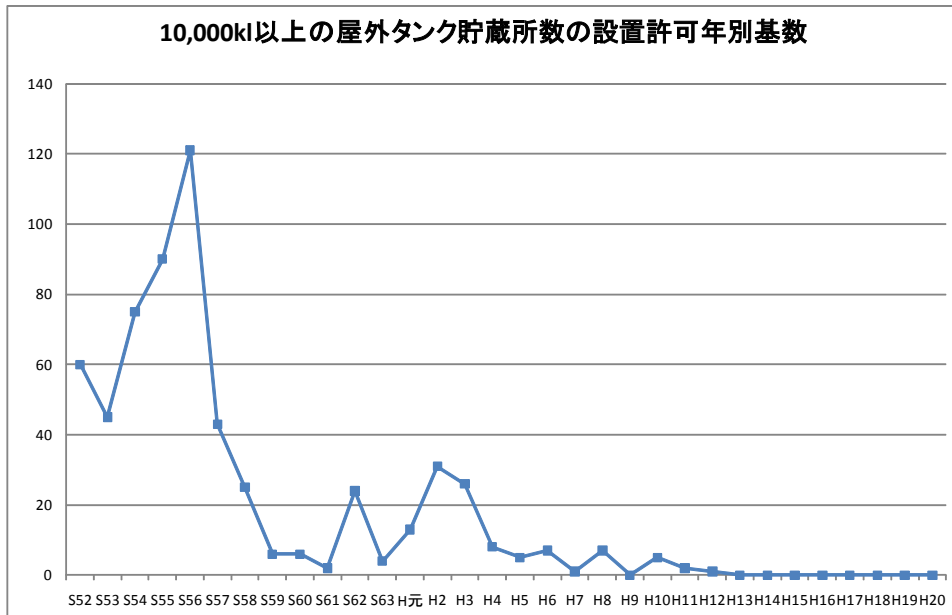
	保安検査 基数	取替・当て板	肉盛り補修	溶接部補修	補修がなかつた基数
平成12年度	82	10 (12%)	25 (30%)	53 (65%)	22 (27%)
平成11年度	76	8 (11%)	24 (32%)	59 (78%)	18 (24%)
平成10年度	70	11 (16%)	23 (33%)	53 (76%)	14 (20%)

注：補修内容が複数あるものは、当該内容をそれぞれ計上している。

表 2.2.5 平成 18～20 年度及び平成 10～12 年度の保安検査時の補修概要（3 年間の平均）

	保安検査 基数	取替・当て板	肉盛り補修	溶接部補修	補修がな かった基数
平成 18～20 年度平均	69	12 (17%)	42 (61%)	67 (97%)	1 (1%)
平成 10～12 年度平均	76	10 (13%)	24 (32%)	55 (72%)	18 (24%)

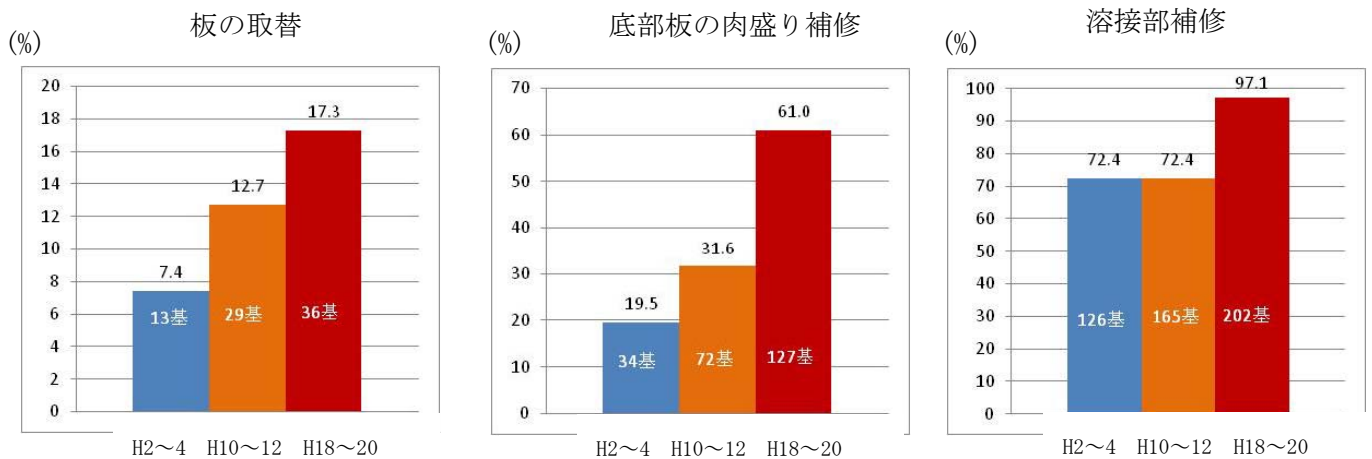

対象タンク数 平成 2～4 年度： 174 基、平成 10～12 年度： 228 基、平成 18～20 年度： 208 基

図 2.2.2 保安検査時に補修があったタンク数及び実施割合
(平成 2～4 年度、平成 10～12 年度、平成 18～20 年度の各平均)

References cited

- 1) Mitsubishi Oil Co Ltd Mizushima Oil Refinery tank accident cause investigation committee: Mitsubishi Oil Co Ltd Mizushima Oil Refinery tank accident cause investigation report, December 18, 1975
- 2) Dangerous article technological standard committee at Fire and Disaster Management Agency: report concerning securing constructional? safety and cycle of inspection of specific outdoor storage tank facilities of old law tank, March, 1994
- 3) Ministry of Public Management, Home Affairs Posts and Telecommunications, Fire and Disaster Management Agency: investigation examination report concerning safety assessment of outdoor storage tank, March, 2003

2.3 Situation of the occurrence of accident

2.3.1 Accident statistics of outdoor storage tank facilities

The outline of spill accidents from tank bottom plate or shell plate of outdoor storage

tank facilities between 1974 and 2007 fiscal year is summarized on Table 2.3.1 (under normal operation) and 2.3.2 (under earthquake) based on the investigation report of “accident case concerning dangerous article” by Fire and Disaster Management Agency of Ministry of Public Management, Home Affairs, Posts, and Telecommunications through whole country fire fighting organization and also the investigation report of “earthquake damage” by fire fighting research center of Fire Defense College of Ministry of Public Management, Home Affairs, Posts, and Telecommunications, Fire and Disaster Management Agency. The tendency to the accident was analyzed since 2.3.2.

2.3.2 Number of Spill accident from bottom of Tank

Number of spill accident from the bottom under normal operation based on Table 2.3.1 is shown in Figures 2.3.1 and 2.3.2 according to capacity. The number of spill accident from the bottom of Tank of 1,000 kl or more in capacity decreases after 1980. This is thought that the effect that the shut down inspection of Tank was obligated in 1977 and executed one by one after 1977 has been brought. On the other hand, the occurrence of the spill accident of Tank of 10,000 kl or more in capacity continues though the safety inspection was executed. Refer to the number of outdoor storage tank facilities (As of March 31, 2009) to Table 2.3.3.



図 2.3.1 容量1千キロリットル以上のタンクの底部からの流出事故件数



図 2.3.2 容量1万キロリットル以上のタンクの底部からの流出事故件数

2.3.3 Spill accident number of outdoor storage tank facilities according to installation passage year

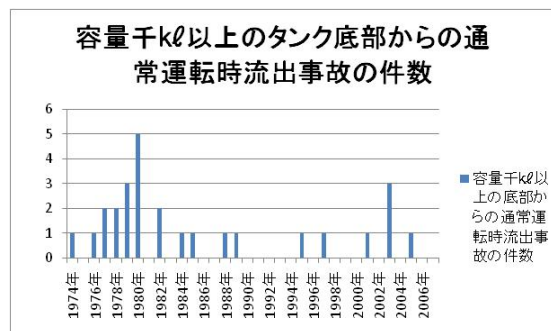
Figure 2.3.3 shows the spill accident number under normal operation based on Table 2.3.1 in each passage year of the installation. When the installation passage year becomes ten years or more, the number of spill accidents shows the tendency to increase. On the other hand, it is thought that the accident number has decreased in 35 years or more because the population parameter is few.

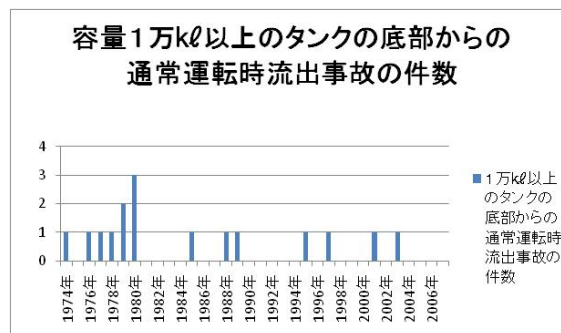

図 2.3.3 屋外タンク貯蔵所の設置経過年別流出事故件

2.3.4 Amount of flow of spill accident from bottom of Tank

Based on Table 2.3.1 and Table 2.3.2, the accident under normal operation is shown in Table 2.3.3 and the accident at the earthquake in Table 2.3.4 respectively about the relation between the spill accident number and the amount of flow of the Tank according to capacity. It is understood that the amount of the average spill of the one of 10,000 kl or more in capacity is considerably large compared with the one of less than 10,000 kl in capacity, and the amount of flow at the earthquake especially grows.

表 2.3.3 タンクの底部からの流出事故（通常運転時）の平均流出量

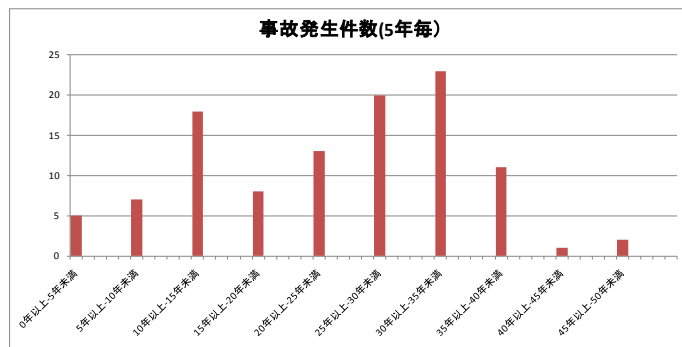
タンク容量	施設件数 (H20 年度統計)	流出事故件数 < >内は流出量不明の件数	平均流出量 (不明除く) (キロリットル)
1 千キロリットル未満	61, 425	52 < 8 >	6.0
1 千キロリットル以上 1 万キロリットル未満	5, 617	11	12.8
1 万キロリットル以上	2, 361	16 < 1 >	3, 230.5

表 2.3.4 タンクの底部からの地震時流出事故の平均流出量

タンク容量	施設件数 (H20 年度統計)	流出事故件数	平均流出量 (キロリットル)
1 千キロリットル未満	61,425	0	0.0
1 千キロリットル以上 1 万キロリットル未満	5,617	2	0.0
1 万キロリットル以上	2,361	5	13,960.6

表 2.3.1 タンク底部板及び側板からの流出事故概要 (通常運転時)

No	Date of Occurrence	Capacity Permitted (kl)	Oil Kind Stored	Part Occurred	Part Detail	Inside Backside	Date Installed	Period (Month & Year) Passed	Damaged Area	Spill Amount (kl)
						Coating Presence				
1	1974/04/04	Unknown	Heavy Oil	Unknown	Unknown	—	Unknown	Unknown	Within Dike	160.0
2	1974/06/12	Unknown	Heavy Oil	Base Metal/ Bottom Plate	Corroded Pore	Unknown	Unknown	Unknown	Within Pit of Dike	0.1
3	1974/08/08	Unknown	Heavy Oil	Base Metal/ Bottom Plate	Corroded Pore	Unknown	Unknown	Unknown	Within Dike	Unknown
4	1974/10/31	Unknown	Sulfuric Acid※	Base Metal/ Shell Plate	Corroded Pore	—	Unknown	Unknown	Within Dike	0.0001
5	1974/12/17	50000	Minas Crude Oil	Unknown	Unknown	Unknown Unknown	Unknown	Unknown	Unknown	0.5
6	1974/12/18	50000	C Heavy Oil	Weld Between Shell & bottom	Crack Part	Unknown	1973 12.15,	1.0	Sea Area	42,888.0
7	1974/12/28	1000	A Heavy Oil	Unknown	Unknown	—	Unknown	Unknown	Within Dike	0.5
8	1975/02/20	Unknown	Heavy Oil	Base Metal/ Bottom Plate	Corroded Pore	Unknown	Unknown	Unknown	Within Site	Unknown
9	1975/04/01	3350	Heavy Oil	Base Metal/ Shell Plate	Corroded Pore	—	Unknown	Unknown	Within Site	0.1
10	1975/04/22	10	A Heavy Oil	Base Metal/ Bottom Plate	Corroded Pore	Unknown	1964 4.1	11.1	Neighbor Rice/Lotus Field	3.5
11	1975/05/30	Unknown	Unrefined Tar	Base Metal/ Bottom Plate	Corroded Pore	Unknown	Unknown	Unknown	Within Dike	192.0
12	1975/08/29	Unknown	Chloro-Sulfonic Acid	Base Metal/ Bottom Plate	Corroded Pore	Unknown	Unknown	Unknown	Within Site	0.01
13	1975/09/12	Unknown	Hydrochloric Acid	Base Metal/ Shell Plate	Corroded Pore	—	1973 6.25	2.2	Within Site	0.1
14	1975/09/20	1084	A Heavy Oil	Weld/ Shell Plate	Corroded Pore	—	Unknown	Unknown	Within Dike	0.2
15	1976/05/14	30000	Heavy Oil	Base Metal/ Bottom Plate	Corroded Pore	Inside Unknown	Unknown	Unknown	Within Dike	0.2
16	1976/09/28	44	Minas Crude Oil	Base Metal/ Bottom Plate	Corroded Pore	Unknown	1961 12.7	14.8	Within Dike	0.8
17	1976/10/08	Unknown	Heavy Oil	Base Metal/ Bottom Plate	Corroded Pore	Unknown	Unknown	Unknown	Within Site	0.1
18	1977/01/31	30000	C Heavy Oil	Base Metal/ Bottom Plate	Corroded Pore	Inside Unknown	Unknown	Unknown	Within Dike	85.0
19	1977/02/07	Unknown	Compound/ Waste Fluid, Toluene, Chlorine-Hydrocarbon	Base Metal/ Bottom Plate	Corroded Pore	Unknown	1975 5.22	1.7	Within Dike	0.1

№	Date of Occurrence	Capacity Permitted (kl)	Oil Kind Stored	Part Occurred	Part Detail	Inside Backside	Date Installed	Period (Month & Year) Passed	Damaged Area	Spill Amount (kl)
						Coating Presence				
20	1977/03/17	241	Heavy Oil	Base Metal/ Bottom Plate	Corroded Pore	Unknown	Unknown	Unknown	公共下水管	9.0
21	1977/11/07	Unknown	Jet A-1 Oil	Base Metal/ Bottom Plate	Corroded Pore	Unknown	Unknown	Unknown	Sea Area	0.5
22	1977/12/08	4700	Light Oil	Weld/ Bottom Plate	割れ	Unknown	1958 4.28	19.6	Within Dike	Unknown
23	1978/02/27	988	Heavy Oil	Base Metal/ Bottom Plate	Corroded Pore	Unknown	1968 3.27	9.9	ドレンボックス下部	0.0005
24	1978/05/15	4740	Heavy Oil	Base Metal/ Shell Plate	Corroded Pore	—	Unknown	Unknown	Within Site	0.04
25	1978/06/16	24000	Crude Oil	Base Metal/ Bottom Plate	摩耗開口部	Unknown Unknown	1973 9.17	4.7	Within Dike	49.7
26	1978/07/29	3000	Heavy Oil	Base Metal/ Bottom Plate	Corroded Pore	Inside Unknown	Unknown	Unknown	Within Site	1.2
27	1979/01/08	300	B Heavy Oil	Base Metal/ Bottom Plate	Corroded Pore	Unknown	Unknown	Unknown	構内排水溝	2.7
28	1979/02/04	50000	Crude Oil	Weld/ Bottom Plate	Crack Part	—	Unknown	Unknown	構内排水溝	50.0
29	1979/02/13	7350	C Heavy Oil	Base Metal/ Bottom Plate	Corroded Pore	Inside Unknown	Unknown	Unknown	Within Site	1.2
30	1979/04/22	22855	C Heavy Oil	Base Metal/ Bottom Plate	Corroded Pore	Inside Unknown	Unknown	Unknown	Within Site	0.02
31	1979/08/08	160	Heavy Oil	Base Metal/ Bottom Plate	Corroded Pore	Unknown	Unknown	Unknown	Within Site	22.0
32	1979/11/24	Unknown	The first Oil Product Group	Base Metal/ Shell Plate	Corroded Pore	—	Unknown	Unknown	Within Site	0.2
33	1979/12/21	Unknown	Minas Crude Oil	Base Metal/ Bottom Plate	Crack Part	Unknown	Unknown	Unknown	Within Dike	0.5
34	1980/02/06	99,000	Crude Oil	Weld/ Bottom Plate	Crack Part	—	1971 9.14	8.4	Within Site	0.07
35	1980/02/23	4000	C Heavy Oil	Base Metal/ Bottom Plate	Corroded Pore	Backside	1958 4	21.9	Within Dike	10.9
36	1980/05/12	30	Compound Liquid/ Ethyl acetate, Dichloro-methane(48 Vol. %)	Base Metal/ Bottom Plate	Corroded Pore	Unknown	Unknown	Unknown	Within Site	0.003
37	1980/06/12	Unknown	Polybutene(火災)	Base Metal/ Shell Plate	Corroded Pore	—	Unknown	Unknown	Within Dike	Unknown
38	1980/06/16	390	C Heavy Oil	Base Metal/ Bottom Plate	Corroded Pore	Unknown	Unknown	Unknown	Within Site	3.0

№	Date of Occurrence	Capacity Permitted (kl)	Oil Kind Stored	Part Occurred	Part Detail	Inside Backside Coating Presence	Date Installed	Period (Month & Year) Passed	Damaged Area	Spill Amount (kl)
39	1980/06/26	30000	Kerosene	Base Metal/ Bottom Plate	Corroded Pore	Inside Unknown	Unknown	Unknown	構内地中	16.0
40	1980/08/01	Unknown	Gasoline	Base Metal/ Bottom Plate	Corroded Pore	Unknown	Unknown	Unknown	Within Site	Unknown
41	1980/08/09	Unknown	Minas Crude Oil	Base Metal/ Shell Plate	Corroded Pore	—	Unknown	Unknown	Within Site	1.6
42	1980/09/28	Unknown	Heavy Oil	Base Metal/ Bottom Plate	Corroded Pore	Unknown	Unknown	Unknown	Within Dike	2.0
43	1980/12/06	3180	Naphtha	Base Metal/ Bottom Plate	Corroded Pore	Inside Unknown	1972 1.17	8.9	Within Site	Unknown
44	1980/12/22	10926	Light Oil	Base Metal/ Bottom Plate	Corroded Pore	Inside Unknown	1972 3.4	8.8	Within Site	Unknown
45	1981/03/20	Unknown	Acetone	Base Metal/ Bottom Plate	Corroded Pore	Unknown	Unknown	Unknown	Within Site	0.2
46	1981/06/22	Unknown	C Heavy Oil	Base Metal/ Shell Plate	Corroded Pore	—	Unknown	Unknown	Within Site	0.0002
47	1981/08/06	28	A Heavy Oil	Weld/ Shell Plate	Corroded Pore	—	1978 3.18	3.4	Within Site	0.001
48	1981/09/01	4655	C Heavy Oil	Weld/ Shell Plate	Corroded Pore	—	1972 2.21	9.5	Within Site	0.0195
49	1981/12/02	150	A Heavy Oil	Base Metal/ Bottom Plate	Corroded Pore	Unknown	Unknown	Unknown	Neighbor Rice/Lotus Field	5.0
50	1982/02/05	3	Kerosene	Base Metal/ Bottom Plate	Corroded Pore	Unknown	1970 10.27	11.3	構外河川	0.1
51	1982/07/01	140	Methanol	Base Metal/ Shell Plate	Corroded Pore	—	1970 7.22	11.9	Within Site	Unknown
52	1982/08/10	1024	Gasoline	Base Metal/ Bottom Plate	Corroded Pore	Inside Unknown	1964 1.24	18.5	構外畑地	46.1
53	1982/09/29	2000	C Heavy Oil	Base Metal/ Bottom Plate	Corroded Pore	Backside	1969 5.1	13.4	Within Site	0.8
54	1982/10/21	995	Soybean Oil	Base Metal/ Bottom Plate	Corroded Pore	Unknown	1970 5.9	12.5	Within Site	Unknown
55	1982/12/09	500	Heavy Oil	Weld/ Bottom Plate	割れ	Unknown	1961 11.18	21.1	Within Dike	0.003
56	1982/12/22	31	C Heavy Oil	Base Metal/ Bottom Plate	Corroded Pore	Unknown	1971 10.19	11.2	Within Dike	0.2
57	1982/12/24	120	Heavy Oil	Base Metal/ Bottom Plate	Corroded Pore	Unknown	1968 5.23	14.6	Sea Area	60.0
58	1984/04/23	10	A Heavy Oil	Base Metal/ Bottom Plate	Corroded Pore	Inside Unknown	Unknown	Unknown	構外河川	0.1
59	1984/05/15	510	A Heavy Oil	Base Metal/ Bottom Plate	Corroded Pore	Unknown	1963 11.1	20.5	構内地中	17.8

No	Date of Occurrence	Capacity Permitted (kl)	Oil Kind Stored	Part Occurred	Part Detail	Inside Backside	Date Installed	Period (Month & Year) Passed	Damaged Area	Spill Amount (kl)
						Coating Presence				
60	1984/11/22	300	C Heavy Oil	Base Metal/ Bottom Plate	Corroded Pore	Unknown	1971 6.28	13.4	構内	0.3
61	1984/12/10	1500	B Heavy Oil	Base Metal/ Bottom Plate	Corroded Pore	Inside Unknown	1952 6.12	32.5	Within Site	0.6
62	1985/06/11	109817	Crude Oil	ミキサー下部 アニュラ板	Corroded Pore	Inside Unknown	1972 10.3	12.7	Within Dike	0.1
63	1985/08/23	2000	Creosote Oil	Base Metal/ Shell Plate	Corroded Pore	—	1980 5.7	5.3	Within Dike	1.0
64	1985/10/04	145	Kerosene	Weld/ Bottom Plate	Crack Part	—	1973 10.25	11.9	Neighbor Rice/Lotus Field	0.2
65	1985/10/29	106	Concentrated Sulfuric Acid	Base Metal/ Bottom Plate	Corroded Pore	Unknown	1976 12.2	8.9	Within Dike	1.9
66	1985/11/29	500	Light Oil	Base Metal/ Bottom Plate	Corroded Pore	Unknown	1966 4.4	19.7	Within Dike	5.0
67	1986/01/06	600	Epichlorohydrin	Base Metal/ Bottom Plate	Corroded Pore	Unknown	1967 12.16	18.1	Within Dike	4.5
68	1986/08/30	15	B Heavy Oil	Base Metal/ Bottom Plate	Corroded Pore	Unknown	1974 3.27	12.4	Within Dike	0.1
69	1986/11/07	107	Kerosene	Base Metal/ Bottom Plate	Corroded Pore	Unknown	1974 2.4	12.8	犬走り部	Unknown
70	1987/06/11	50	Lubricating Oil	Bottom Plate- Manhole Flange	開放部/ Corroded Pore	Unknown	1973 3.28	14.2	防油堤ピット内	Unknown
71	1987/09/08	20	De-sulfurized C Heavy Oil	Base Metal/ Shell Plate	Corroded Pore	—	1970 10.7	16.9	Within Dike	10.4
72	1987/09/09	145	A Heavy Oil	Base Metal/ Bottom Plate	Crack Part	Unknown	1971 6.29	16.2	Sea Area	9.7
73	1988/07/05	82641	Crude Oil	Weld/ Bottom Plate	Crack Part	Unknown	1975 3.6	13.3	地中	0.4
74	1988/08/26	2000	Heavy Oil	Base Metal/ Shell Plate	Corroded Pore	—	1968 7.18	20.1	Within Dike	0.2
75	1989/12/17	84548	Crude Oil	Base Metal/ Bottom Plate	Corroded Pore	Inside Unknown	1973 8.3	16.4	Within Dike	0.8
76	1991/02/24	15	Heavy Oil	Base Metal/ Bottom Plate	Corroded Pore	Unknown	1969 3.3	22.0	Within Dike	2.0
77	1991/09/06	4000	Molten Sulphur	Base Metal/ Shell Plate	Corroded Pore	—	1969 9.10	23.0	構内	0.3
78	1991/10/04	2400 ton	Molten Sulphur	Base Metal/ Shell Plate	Corroded Pore	—	1976 11.18	14.9	構内	43.7
79	1992/07/29	40	Heavy Oil	Base Metal/ Shell Plate	Corroded Pore	—	1979 3.28	13.3	Within Dike	0.001
80	1992/08/21	995	Heavy Oil	Base Metal/ Bottom Plate	Corroded Pore	Unknown	1961 3.23	31.4	Within Dike	5.0

№	Date of Occurrence	Capacity Permitted (kl)	Oil Kind Stored	Part Occurred	Part Detail	Inside Backside	Date Installed	Period (Month & Year) Passed	Damaged Area	Spill Amount (kl)
						Coating Presence				
80	1992/08/21	995	Heavy Oil	Base Metal/ Bottom Plate	Corroded Pore	Unknown	1961 3.23	31.4	Within Dike	5.0
81	1992/11/24	1750	Gasoline	Base Metal/ Shell Plate	Crack Part	—	1961 12.6	31.0	Within Dike	0.2
82	1994/07/01	50	Light Oil	Base Metal/ Shell Plate	Corroded Pore	—	1973 11.29	20.6	タンク犬走り	0.0005
83	1994/08/10	125	Lubricating Oil	Base Metal/ Bottom Plate	Corroded Pore	Unknown	1964 10.5	29.8	タンク基礎地盤のみ	0.9
84	1994/08/25	500	Kerosene	側板サポート取付け部	Corroded Pore	—	1973 10.3	20.9	タンク犬走り	0.001
85	1995/01/07	420	A Heavy Oil	Base Metal/ Shell Plate	Corroded Pore	—	1967 12.22	27.0	被害なし	Unknown
86	1995/01/13	28970	Light Oil	Weld/ Bottom Plate	割れ	Unknown	1968 5.15	26.7	Within Dike	142.6
87	1995/03/27	192	A Heavy Oil	Base Metal/ Bottom Plate Weld/ Bottom Plate	割れ	—	1966 6.5	28.8	Sea Area	0.2
88	1995/05/18	10	Heavy Oil	Base Metal/ Shell Plate	Corroded Pore	—	1973 7.6	21.9	構外河川	8.5
89	1996/02/29	30	Heavy Oil	Base Metal/ Bottom Plate	Corroded Pore	Unknown	1969 4.23	26.9	Sea Area	1.2
90	1997/04/13	110000	Crude Oil	Base Metal/ Bottom Plate	Corroded Pore	Inside 有	1972 9.28	24.5	Within Dike	1.3
91	1997/05/09	300	Gasoline	Base Metal/ Bottom Plate	Corroded Pore	Unknown	1970 11.2	26.5	構外河川	Unknown
92	1997/05/28	200	A Heavy Oil	Base Metal/ Bottom Plate	Corroded Pore	Unknown	1971 6.2	26.0	Sea Area	26.0
93	1997/07/10	670	Light Oil	Base Metal/ Bottom Plate	Corroded Pore	Unknown	1976 11.16	20.7	Within Dike	0.1
94	1997/11/13	20	A Heavy Oil	Base Metal/ Bottom Plate	Corroded Pore	Unknown	1973 2.3	24.8	構外河川	0.2
95	1998/03/04	500	Kerosene	Base Metal/ Bottom Plate	Corroded Pore	Unknown	1971 11.19	26.3	Sea Area	Unknown
96	1998/05/23	200	Heavy Oil	Base Metal/ Bottom Plate	Corroded Pore	Unknown	1972 3.28	26.2	Within Dike	20.0
97	1998/07/04	30	A Heavy Oil	Base Metal/ Bottom Plate	Corroded Pore	Unknown	1971 8.30	26.8	構外河川	0.5
98	1999/01/09	12	Heavy Oil	Base Metal/ Bottom Plate	Crack Part	—	1970 7.30	28.4	Within Dike	0.7
99	1999/01/15	54	Light Oil	Base Metal/ Shell Plate	Corroded Pore	—	1972 9.2	26.4	Sea Area	1.0
100	1999/05/21	1450	Gasoline	Base Metal/ Shell Plate	Corroded Pore	—	1972 11.13	26.5	Within Dike	0.003
101	1999/06/11	4	Light Oil	Base Metal/ Bottom Plate	Corroded Pore	Unknown	1976 12.8	31.5	犬走り部	Unknown

№	Date of Occurrence	Capacity Permitted (kl)	Oil Kind Stored	Part Occurred	Part Detail	Inside Backside	Date Installed	Period (Month & Year) Passed	Damaged Area	Spill Amount (kl)
						Coating Presence				
102	1999/08/12	481	C Heavy Oil	Base Metal/ Shell Plate	Corroded Pore	—	1963 10.24	35.8	Within Dike	0.02
103	1999/10/11	2160	C Heavy Oil	Base Metal/ Shell Plate	Corroded Pore	—	1972 10.5	27.0	構内	0.5
104	1999/10/20	880	A Heavy Oil	Base Metal/ Bottom Plate	Corroded Pore	Unknown	1980 12.15	18.8	Sea Area	6.3
105	2001/06/01	4880	Gasoline	Base Metal/ Shell Plate	Corroded Pore	—	1970 9.29	30.7	Within Dike	Unknown
106	2001/06/27	50000	Crude Oil	Base Metal/ Bottom Plate	Corroded Pore	Inside 有	1970 12.4	30.6	Within Dike	8.0
107	2001/08/15	15	Heavy Oil	Base Metal/ Shell Plate	Corroded Pore	—	1966 2.23	35.5	Within Dike	0.3
108	2001/07/31	2050	JETA- 1	Base Metal/ Shell Plate	Corroded Pore	—	1970 11.19	30.7	Within Dike	0.1
109	2001/12/29	35000	Crude Oil	Base Metal/ Shell Plate	Corroded Pore	—	1969 4.10	32.7	Within Dike	0.002
110	2002/04/01	455	FCC Bottom Oil	Base Metal/ Bottom Plate	Corroded Pore	Unknown	1957 2.5	45.2	Sea Area	Unknown
111	2002/06/07	1255	C Heavy Oil	Base Metal/ Shell Plate	Corroded Pore	—	1975 12.9	26.5	構内	0.005
112	2002/07/02	40000	Crude Oil	Base Metal/ Shell Plate	Corroded Pore	—	1971 5.26	31.1	構内	Unknown
113	2002/09/05	500	C Heavy Oil	Base Metal/ Shell Plate	Corroded Pore	—	1970 10.27	31.9	Within Dike	2.0
114	2003/01/25	9800	Crude Oil	Base Metal/ Bottom Plate	Corroded Pore	Inside Unknown	1967 12.26	35.1	構内	0.03
115	2003/02/07	995	Light Oil	Base Metal/ Bottom Plate	Corroded Pore	Unknown	1962 1.18	41.1	構内	0.1
116	2003/02/24	700	Xylene	Base Metal/ Bottom Plate	Corroded Pore	Unknown	1965 12.28	37.2	Sea Area	Unknown
117	2003/03/15	50000	Crude Oil	Base Metal/ Bottom Plate	Corroded Pore	Inside 有	1970 3.15	33.0	構内	0.13
118	2003/03/20	57	Heavy Oil	Base Metal/ Shell Plate	Corroded Pore	—	1976 4.15	26.9	構内	0.2
119	2003/03/27	8	Heavy Oil	Base Metal/ Shell Plate	Corroded Pore	—	1992 9.4	11.6	構内	0.1
120	2003/06/11	100	Heavy Oil	Weld/ Bottom Plate	割れ	—	1971 6.11	32.0	構外河川	Unknown
121	2003/07/07	2000	Styrene	Base Metal/ Bottom Plate	Corroded Pore	Backside	Unknown	Unknown	構内	0.2
122	2003/10/23	40	Heavy Oil	Base Metal/ Bottom Plate	Corroded Pore	Unknown	1967 10.12	36.0	Within Dike	0.1
123	2003/12/15	2330	Heavy Oil	Base Metal/ Shell Plate	Corroded Pore	—	1968 9.18	35.2	Within Dike	0.04

№	Date of Occurrence	Capacity Permitted (kl)	Oil Kind Stored	Part Occurred	Part Detail	Inside Backside	Date Installed	Period (Month & Year) Passed	Damaged Area	Spill Amount (kl)
						Coating Presence				
124	2004/06/01	130	Heavy Oil	Base Metal/ Bottom Plate	Corroded Pore	Unknown	1973 7.25	30.9	Within Dike	0.4
125	2004/07/22	7830	Heavy Oil	Base Metal/ Shell Plate	Corroded Pore	—	1980 10.21	23.8	Within Dike	0.045
126	2005/01/06	28	Heavy Oil	Base Metal/ Shell Plate	Corroded Pore	—	1968 12.27	36.0	Within Dike	0.4
127	2005/05/26	10	Heavy Oil	Base Metal/ Shell Plate	Corroded Pore	—	1976 11.2	28.6	Within Dike	0.001
128	2005/07/01	1680	Heavy Oil	Weld Between Shell & Bottom	Corroded Pore	—	1969 3.27	36.3	Within Dike	0.1
129	2005/09/15	12000	Light Oil	Base Metal/ Shell Plate	Corroded Pore	—	1972 12.27	32.7	Within Dike	0.2
130	2005/09/21	7000	Heavy Oil	Base Metal/ Shell Plate	Corroded Pore	—	1959 4.3	46.5	Within Dike	0.1
131	2005/11/14	620	Methyl Isobutyl Ketone	Base Metal/ Shell Plate	Corroded Pore	—	1970 2.12	35.8	Within Dike	0.003
132	2005/11/22	620	Butyl Acetate	Base Metal/ Shell Plate	Corroded Pore	—	1970 1.27	35.8	Within Dike	Unknown
133	2005/12/07	2400	Naphtha	Base Metal/ Bottom Plate	Corroded Pore	Inside 有	1973 9.17	32.2	構外河川	80.0
134	2006/03/01	10	Kerosene	Base Metal/ Bottom Plate	Corroded Pore	Unknown	1974 11.9	31.3	水路	Unknown
135	2006/04/08	20	Heavy Oil	Base Metal/ Bottom Plate	Corroded Pore	Unknown	1975 7.16	30.7	構内排水溝	Unknown
136	2006/06/08	234	Nitric Acid	Weld/ Bottom Plate	割丸部	—	1968 6.11	38.0	Within Dike	0.0002
137	2006/07/01	15	Heavy Oil	Base Metal/ Shell Plate	Corroded Pore	—	1977 2.18	29.4	水田	1.2
138	2006/07/06	24250	Light Oil	Base Metal/ Shell Plate	Corroded Pore	—	1971 12.27	34.5	Within Dike	Unknown
139	2006/07/16	20	Heavy Oil	Base Metal/ Bottom Plate	Corroded Pore	Unknown	1981 7.11	25.0	Within Dike	1.0
140	2006/08/01	9950	Heavy Oil	Base Metal/ Shell Plate	Corroded Pore	—	1972 3.4	34.4	Within Dike	Unknown
141	2006/08/10	5060	Gasoline	Base Metal/ Shell Plate	Corroded Pore	—	1972 3.4	34.4	構内	Unknown
142	2007/03/15	740	Heavy Oil	屋根支柱保護板 / Bottom Plate	Corroded Pore	Unknown	1973 9.6	33.5	地中	50.0
143	2007/04/01	200	Heavy Oil	Weld Between Shell & Bottom	Corroded Pore	Unknown	1978 6.19	28.8	Within Dike	0.002
144	2007/05/13	200	Sludge	Base Metal/ Shell Plate	Corroded Pore	—	1973 12.17	33.4	Within Dike	Unknown
145	2007/11/26	53620	Gasoline	Base Metal/ Shell Plate	Corroded Pore	—	1974 10.15	33.1	Within Dike	0.012

表 2.3.2 タンクの底部板及び側板からの流出事故概要（地震時）

No.	発生年月日	許可容量 (キロリットル)	貯蔵油種	発生箇所	設置年月日	経過年.月	事故原因	流出量 (キロリットル)
1	1978/6/12	31,421	灯油	アニュラ板 ×側板	1972/8/15	5.8	宮城県 沖地震	滲み
2	1978/6/12	31,470	重油	底部亀裂	1972/11/8	5.6	宮城県 沖地震	26798
3	1978/6/12	31,508	重油	底部亀裂	1972/12/18	5.5	宮城県 沖地震	23705
4	1978/6/12	23,608	減圧軽油	底部亀裂	1973/1/25	5.4	宮城県 沖地震	45
5	1978/6/12	23,588	減圧軽油	底部亀裂	1973/1/25	5.4	宮城県 沖地震	17644
6	1983/5/26	2,000	軽油	底板×側板	不明	12.7	日本海 中部地 震	滲み
7	1983/5/26	1,000	軽油	底板（ドレ ン部）	不明	11.6	日本海 中部地 震	滲み
8 (参考)	1993/1/15	1,035 m ³	アスフ ァルト	側板座屈部	1972/7/29	20.5	釧路沖 地震	900t
9	1993/1/15	5,000	重油	側板座屈部	不明	不明	釧路沖 地震	不明
10	1995/1/17	420	A重油	側板	1967/12/22	27.1	兵庫県 南部地 震	滲み
11	1995/1/17	990	エチル アルコ ール	側板（座屈）	1973/9/21	21.3	兵庫県 南部地 震	3

2.4 Inside corrosion of Tank bottom

To understand the realities of the progress of thinning due to inside corrosion that was one of the deterioration factors of Tank, the inside corrosion data collected in the past was arranged and analyzed. Since it was considered that there was no difference about the characteristic of inside corrosion between in the new law Tank and in the old law Tank, the data of the old law Tank was used about assorted traits (Figure 2.4.1 of 2.4.1 and 2.4.2(2)) where the number of data of the new law Tank was insufficient to secure the number of data necessary to the analysis. Refer to 2.6.5(4) for the measuring method of the inside corrosion depth of the tank bottom.

2.4.1 Investigation of actual conditions of inside corrosion speed

Figure 2.4.1 shows the relation between minimum bottom plate thickness due to inside corrosion and in year of passage from the installation of Tank where the spill accident occurs from thinning due to inside corrosion and the corrosion history was understood by Accident Cause Report ^{1)~4)} (The accident number corresponds to the number in Table 2.3.1). The ordinate shows minimum plate thickness (design thickness when set up) due to inside corrosion of the Tank bottom. The thinnest plate thickness of measured one on inspection was connected with the last plate thickness by the straight line, of which inclination was assumed to be a corrosion rate. In this case, the value in which "Corrosion depth that was 0.1mm less than the minimum corrosion depth (value that the owner set as a specification of the repair)" was subtracted from the design plate thickness was assumed to be estimated minimum one after had been repaired. The following two corrosion rates were calculated because there was no one cycle before inspection record of the minimum plate thickness part at that time inspection since the second times.

A: Presumption upper bound value that is assumed that the maximum, inside corrosion part occurred at a part which had design plate thickness on the last time inspection.

B: Presumption lower bound value that is assumed that the maximum, inside corrosion part occurred at a part that was minimum plate thickness after repaired on the last time inspection.

From this figure spill accident occurred when the inside corrosion speed increased rapidly, and it is understood that there was a change in the corrosion rate, and the change about 3 or 4 times could happen enough.

Figure 2.4.2 and Table 2.4.2 are averages of the maximum, inside corrosion rate of the bottom plate and annular plate of the new law Tank of which data are shown in Table 2.4.1 per each frequency of inspection. The one due to defect by striking was included

while the one of the plate substitution without measuring the inside corrosion depth* and the case that the corrosion rate could not be calculated because of the uncertainty of the details of the repair were excluded in calculating on average corrosion rate. The corrosion historical data was offered by Hazardous Materials Safety Techniques Association, of which the oldest one in each Tank was regarded as the first data respectively and, in addition, after second time the corrosion rate was calculated by the above mentioned method. So, corrosion rate calculated tends to be small.

*It was likely to exchange it at the opening time followed without measuring the thickness of the plate with an intense corrosion. In this case, the corrosion depth was not understood. As such, there were constant cases that were not investigated and recorded though there was big corrosion. They have become obstacles in understanding realities and analyzing the data.

According as the level of the mean value at the inside corrosion rate and its change level (ratio of each time mean values to the minimum value) are shown in Figure 2.4.2 and Table 2.4.2, it is understood that the difference is in the corrosion rate depending upon the frequency of internal inspection and the part. It is also understood that the inside corrosion rate of the bottom plate is larger than that of the annular plate, and the corrosion rate has changed into about 1.7 times or less on the annular plate and into about 1.7 times or less on the bottom plates as long as the inside corrosion rate grows by increasing of the frequency of internal inspection. Through the above, it can be said that it is clarified to have to pay the great caution to progress of inside corrosion in the bottom plate, and to have to pay attention to inside corrosion as years have passed since set up.

事故事例 62

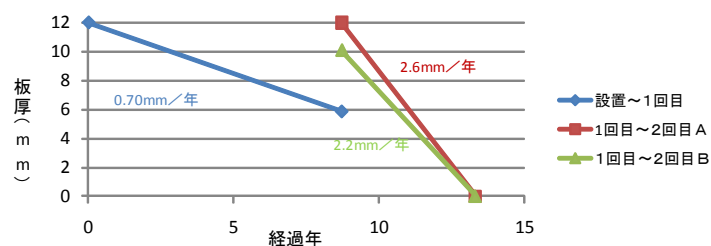

事故事例 90

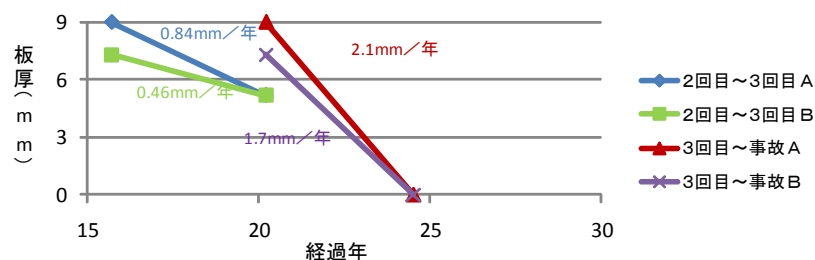

事故事例 106

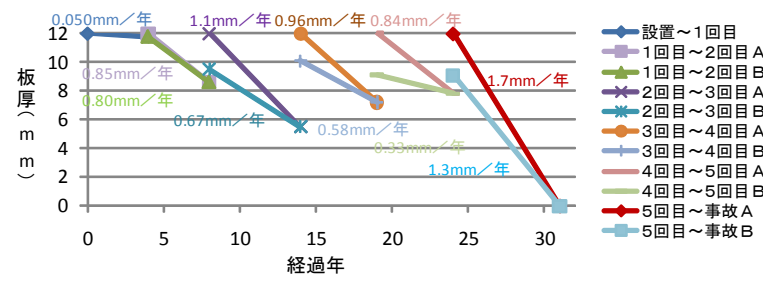

事故事例 117

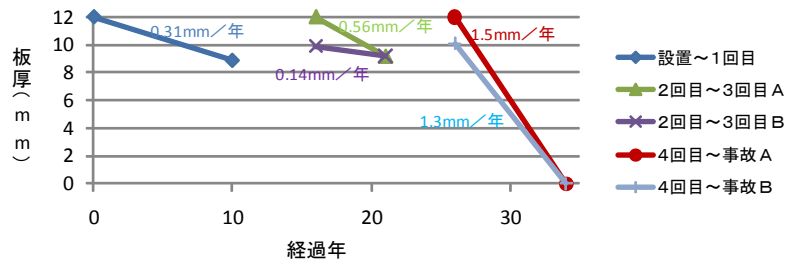

事故時の内面腐食速度

- ①事例 62 : 2.2~2.6mm/年 (前回開放時 0.70mm/年)
- ②事例 90 : 1.7~2.1mm/年 (前回開放時 0.46~0.84 年)
- ③事例 106 : 1.3~1.7mm/年 (前回開放時 : 0.33~0.84mm/年)
- ④事例 117 : 1.3~1.5mm/年 (前回開放時 : 0.14~0.56mm/年)

図 2. 4. 1 内面腐食による事故のあったタンクの内面腐食履歴

表 2. 4. 1 内面腐食速度データの得られたタンク数

第 1 回		第 2 回		第 3 回	
アニュラ板	底板	アニュラ板	底板	アニュラ板	底板
616	616	449	454	293	293



図 2. 4. 2 開放回数に対する最大内面腐食速度の平均値

表 2.4.2 内面腐食速度の平均値 (mm/年) とその変化の程度
(平均値の最小に対する各回の平均値の比率 (括弧内))

開放回数	アニュラ板	底板
1 回目	0.072 (1.00)	0.096 (1.00)
2 回目	0.086 (1.19)	0.097 (1.01)
3 回目	0.125 (1.74)	0.134 (1.40)

Using the data of Tank which had been reported to have big inside corrosion(see Reference-1), Figure 2.4.3 shows a display of the inside corrosion rate of each individual Tank by the difference of the frequency of internal inspection among the new law Tanks. It is not the one to show the tendency of all tanks because neither the one of which corrosion depth was small nor the one of which plate was substituted without measuring the corrosion depth was included when data was collected. Moreover, data of Tanks which was clear to be coated in case of internal inspection was excluded because the meanings of the comparison was low since the erosive environment was greatly different before and after coating. It makes a special mention that there were a lot of data that the third time corrosion rate was growing more than the second time one though it was understood that the inside corrosion rate change of each time was extremely large from this figure.

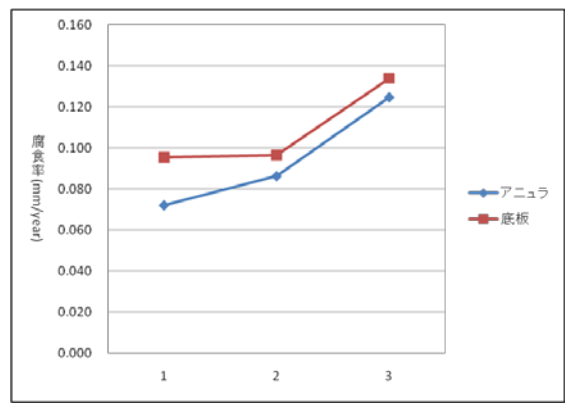
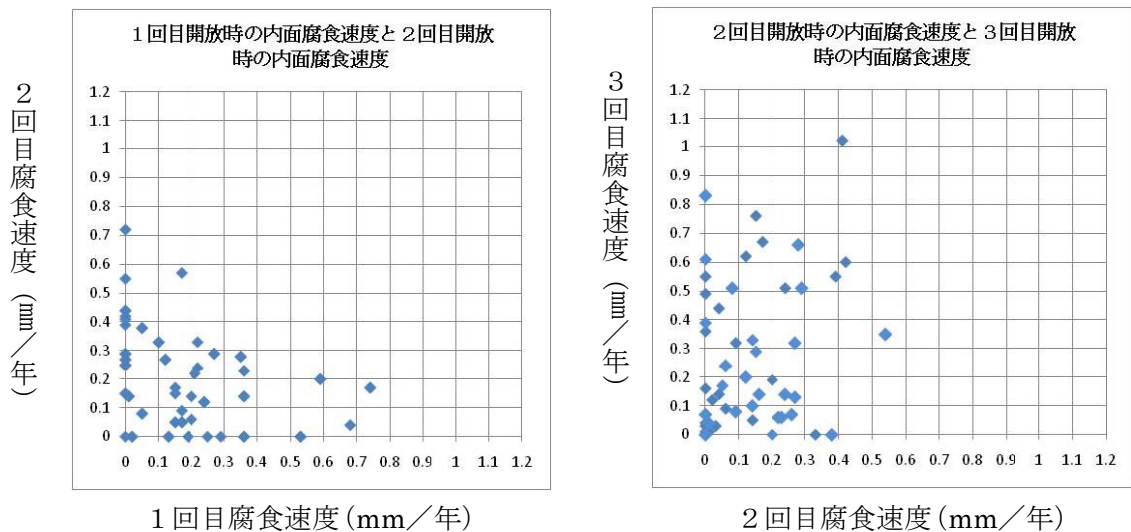

- * 腐食深さが小さかったもの及び腐食深さが測られずに板替えされたものは含まれていない。
- * 開放検査時にコーティングが施工されたことが明らかなものは除外。

図 2.4.3 内面腐食深さが大きかった履歴のあるタンクの 1 回目開放時の内面腐食速度と 2 回目開放時の内面腐食速度 (左) 及び 2 回目開放時の内面腐食速度と 3 回目開放時の内面腐食速度 (右)

2.4.2 Confirmation of inside corrosion prevention function of coating

The corrosion prevention function was analyzed since inside corrosion was able to prevent by the coating and was adopted widely.

(1) Results at inside corrosion rate of Tank where coating was constructed

Figure 2.4.4 shows the inside corrosion rate divided into three categories which are glass flakes (Hereafter, it is said "GF") coatings that are assumed that the inside corrosion prevention function is the highest, the coatings other than GF and without the coating in order to examine the difference according to the kind and presence of the coating. In the figure, neither the one that the plate was substituted nor the one of which corrosion depth were not measured because of small corrosion is included. The data used was summarized in Table 2.4.3. Moreover, data of Tanks which was clear to coat in case of internal inspection was excluded because the meanings of the comparison was low since the erosive environment was greatly different before and after coating. In the figure, high corrosion rates at second and third time inspection were seen in all kinds of Tanks and GF coating of which data were surrounded by the dotted circle was constructed from 1977 to 1979. From this, it is necessary to think that the one with an inferior corrosion prevention function were included in the GF coating constructed at old age.

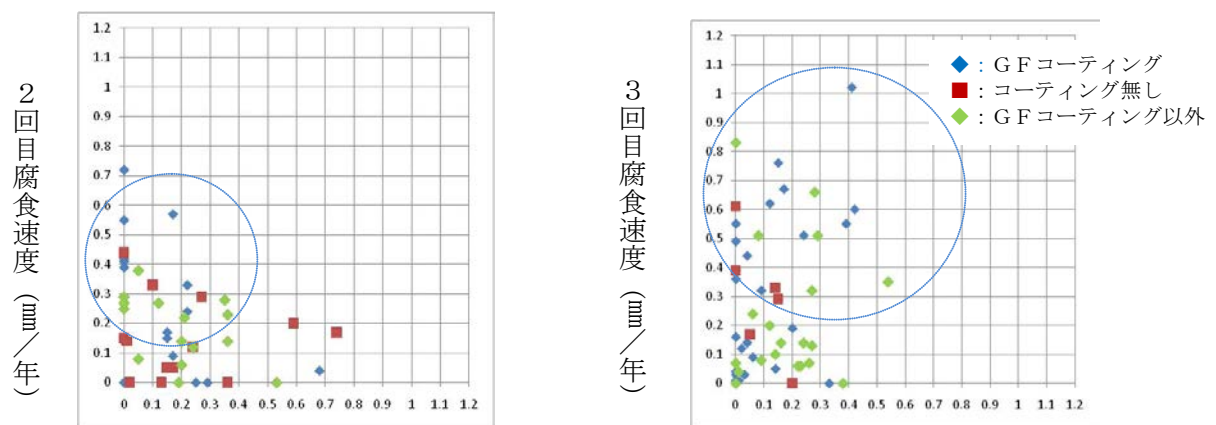

1 回目腐食速度 (mm/年)

2 回目腐食速度 (mm/年)

- * 腐食深さが小さかったもの及び腐食深さが測られずに板替えされたものは含まれていない。
- * 開放検査時にコーティングが施工されたことが明らかなのは除外した。

図 2.4.4 コーティングの種類別に分類した内面腐食深さが大きかった履歴のあるタンクの 1 回目開放時の内面腐食速度と 2 回目開放時の内面腐食速度 (左) 及び 2 回目開放時の内面腐食速度と 3 回目開放時の内面腐食速度 (右)

表 2.4.3 コーティングの内面腐食防止効果データの得られたタンク数

第 1 回				第 2 回				第 3 回			
アニュラ板		底板		アニュラ板		底板		アニュラ板		底板	
616		616		449		454		293		293	
コ有	コ無	コ有	コ無	コ有	コ無	コ有	コ無	コ有	コ無	コ有	コ無
343	273	344	272	356	93	360	94	278	15	274	19

(2) Collection and analysis of trouble case

It was reported in (1) that the inside of some of coated Tanks were corroded, though the corrosion rates of the one on which the coating was constructed were expected to become 0 within the lives of coating. The inspection reports etc. which had trouble case like inside corrosion though the coating had been constructed were collected and analyzed to examine the factor that disturbed the corrosion prevention function (refer to 5.5.2).

(3) Aged deterioration of coating

Figure 2.4.5 shows the frequency distribution at the maximum, inside corrosion rate of each Tank that had been measured in each case of internal inspection and a mean value and the maximum value were summarized in Table 2.4.4. Relative to coating of Tank, in some cases the coating was applied from the beginning of Tank installation and in other cases applied when they were internally inspected after initial installation.

It brought it together in the figure per number of opening for inspection regardless of coating construction time. The corrosion rate was a presumption lower bound value (B of 2.4.1). It is understood that the bigger one of the corrosion rate had increased whenever the frequency of opening for internal inspection increased. It is because the one of which inside corrosion prevention function decreased according to the aged deterioration of the coating increase, and some of them had shown a big corrosion rate.

表 2.4.4 内面腐食速度の平均値、最大値の開放ごとの変化及び対象タンク数

部位	開放回	1回目	2回目	3回目
アニュラ板	腐食速度の平均値 (mm/年)	0.03	0.07	0.15
	腐食速度の最大値 (mm/年)	0.43	0.6	1.01
	タンク基数	276	256	162
底 板	腐食速度の平均値 (mm/年)	0.04	0.08	0.15
	腐食速度の最大値 (mm/年)	0.66	0.79	0.69
	タンク基数	277	249	159



図 2.4.5 GFコーティングが施工されているタンクの開放ごとの内面腐食速度

Data of Tanks of which inside were GF coated from the initial construction and not repainted and in addition, which had more than three times of opening for internal inspection were extracted from the one shown in Figure 2.4.5 to analyze relation between tenure of use and aged deterioration of coating (Refer to Figure 2.4.6 (presumption lower bound value at inside corrosion rate), Figure 2.4.7 (presumption upper bound value at inside corrosion rate), Table 2.4.5 and Tables 2.4.6). From them it is understood that the inside average corrosion rate increased as year passed and until the second times (passage of 14.7 years on the average from the coating construction), there were many Tanks whose inside corrosion is 0 and at third times (passage of 22.8 years on the average from the coating construction) the inside corrosion had been found

in a lot of Tanks though a remarkable peak was not seen. Moreover, the coatings of these Tanks were applied by ether in accordance with Coating Guide or not.

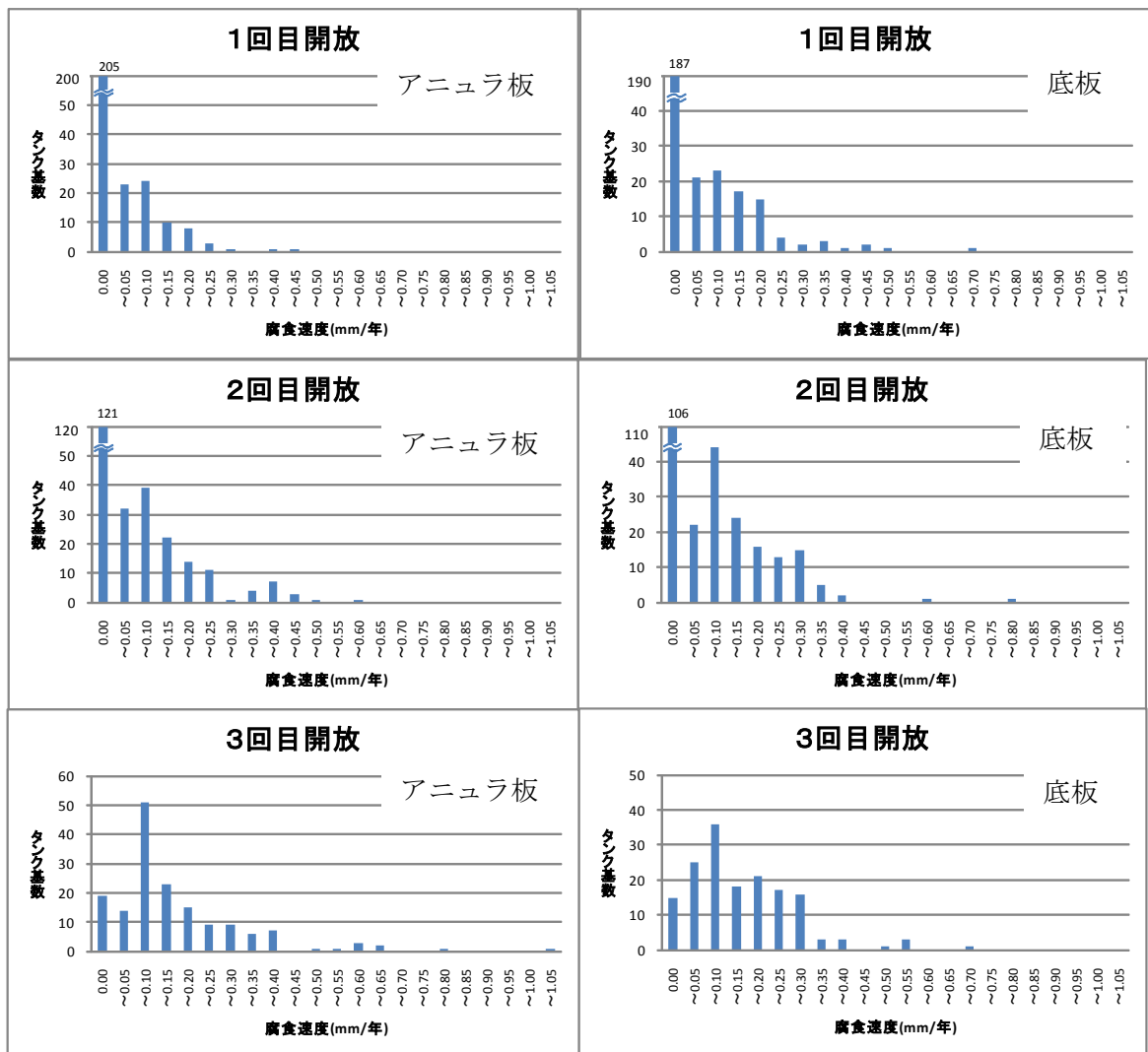

図 2.4.6 建設当初からGFコーティングが施工されているタンクの開放ごとの内面腐食速度の推定下限値

表 2.4.5 内面腐食速度の推定下限値の平均値、最大値の開放ごとの変化及び対象タンク数

部位		第1回開放	第2回開放	第3回開放
アニュラ板	腐食速度の平均値 (mm/年)	0.019	0.041	0.174
	腐食速度の最大値 (mm/年)	0.357	0.429	1.01
	タンク基数	93	93	93
底板	腐食速度の平均値 (mm/年)	0.033	0.047	0.154
	腐食速度の最大値 (mm/年)	0.657	0.367	0.544
	タンク基数	71	71	71

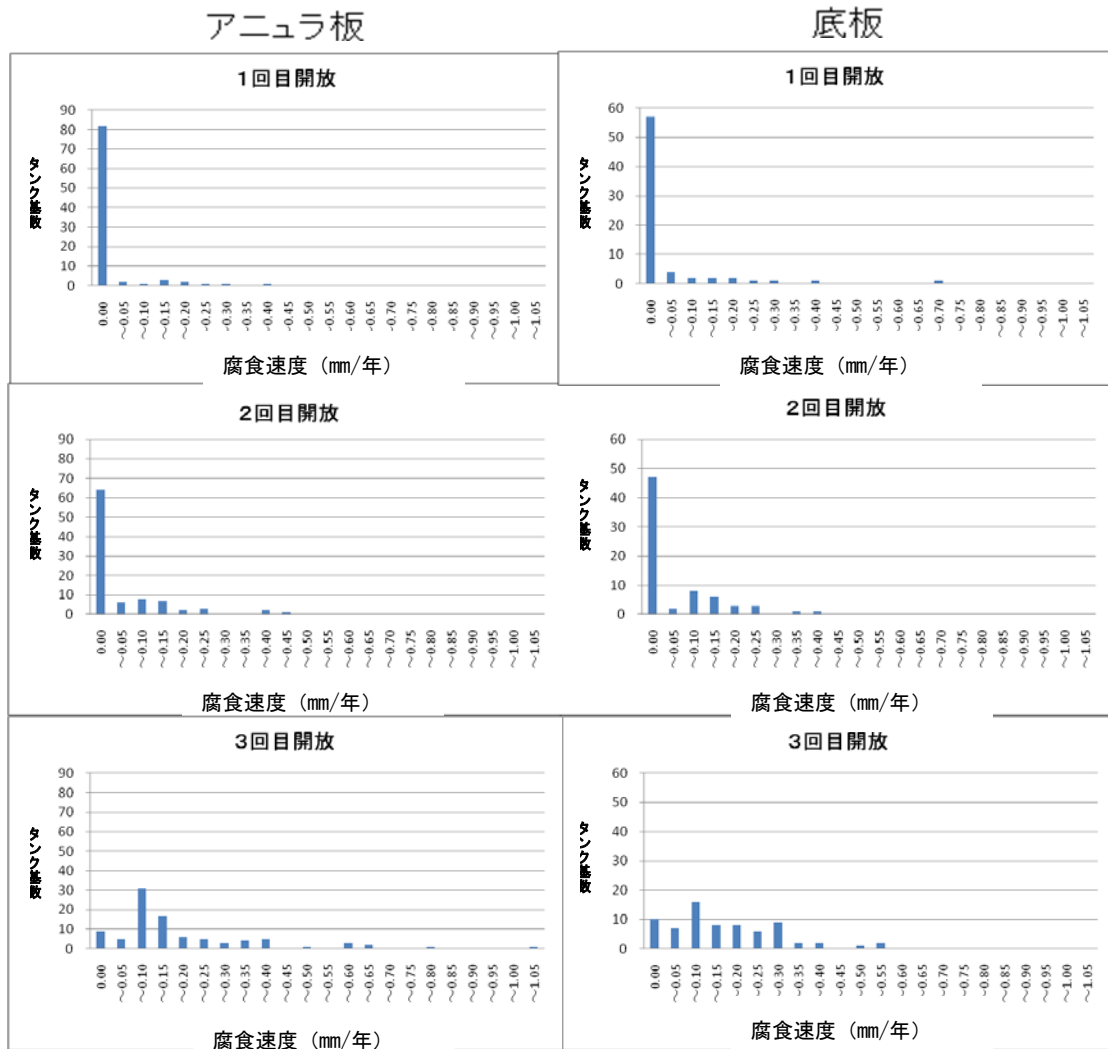

図 2.4.7 建設当初からGFコーティングが施工されているタンクの開放ごとの内面腐食速度の推定上限値

表 2.4.6 内面腐食速度の推定上限値の平均値、最大値の開放ごとの変化及び対象タンク数

部位		第1回開放	第2回開放	第3回開放
アニュラ板	腐食速度の平均値 (mm/年)	0.019	0.049	0.198
	腐食速度の最大値 (mm/年)	0.357	0.429	1.2
	タンク基数	93	93	93
底板	腐食速度の平均値 (mm/年)	0.033	0.063	0.185
	腐食速度の最大値 (mm/年)	0.657	0.479	0.7
	タンク基数	71	71	71

(4) Summary of trouble case and Condition of coating with high corrosion prevention function

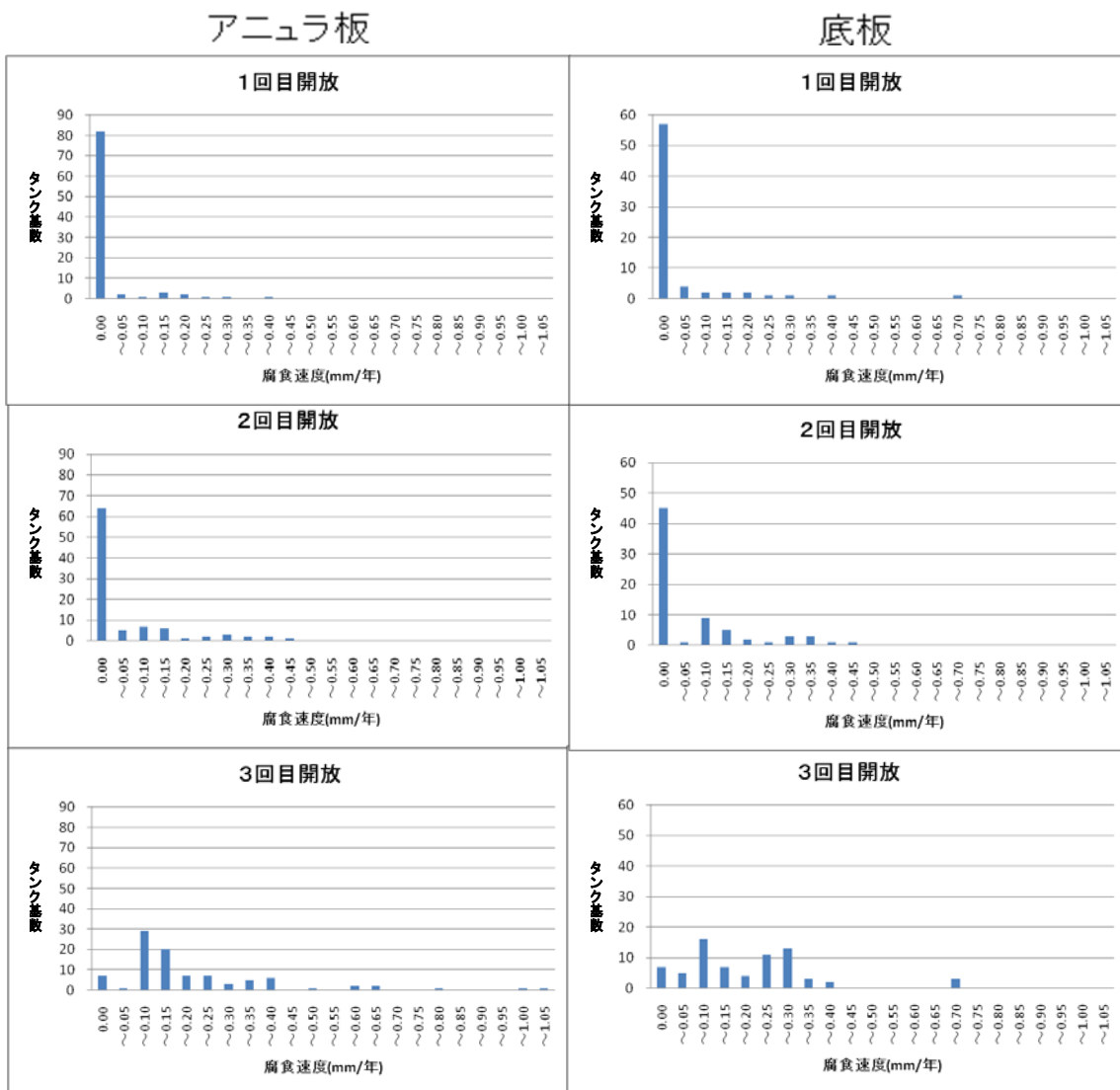
The following can be said by (2), (3).

a. When the coating flakes were off in Tank where the coating was constructed, the corrosion rate might become larger.

b. The factor that the coating flakes off includes the followings.

- Use of paints with low resistance to solvent attack
- Dewfall on surface of painting and adhesion power shortage because of return rust?
- Coating degradation by high temperature
- Adhesion power shortage and corrosion progress by insufficient surface preparation (remaining of salinity and garbage and surface-roughness shortage)
- Film thickness shortage and stiffening shortage because of defective construction

c. The factors that the corrosion rate of the steel plate grows after coating flakes off are as follows.

- Formation of macro cell
- Formation of oxygen concentration cell
- Corrosion with the action of sulfate reduction bacteria and acid etc.

d. Thinning was not plainly found though corrosion such as black rust was found a little under the swelling. It is understood that inside corrosion with large corrosion rate doesn't occur as long as the coating doesn't flake off.

As the problem such as flaking off of the paint film was caused in the coating constructed between 1975 and 1984, the examination of the material quality and conditions of performance of the coating between 1985 and 1994 was done, and a conclusion almost similar to the above-mentioned analysis was obtained. The requirement for the coating that did not flake off easily was brought together as a result of the examination, and "Coating Guide (fire fighting [abuna] No.74 in 1994)" was made. It is thought that trouble by a factor already-known of these is not caused if constructed in accordance with Coating Guide.

(5) Results of Tank coated with Coating Guide

Figure 2.4.8 shows an inside corrosion history of three Tanks to which the GF coating equivalent to the one coated with Coating Guide was constructed at first of construction. Inside corrosion has hardly occurred though it is a tank where 20 years or more passed after the GF coating was constructed. Therefore it is understood that the function to prevent inside corrosion of such GF coating is high. There are 314 new law Tanks of 10,000 kl or more in capacity which had internally inspected more than three times.

29, about 10 percent of the Tanks had GF coating since the initial construction and the inside corrosion rates of both their annular plate and bottom plate were 0.1mm/year or less at the time of each opening. Namely, it is said that about 10 percent of the Tanks which had the results of three opening or more had a little inside corrosion.

Figure 2.4.9 shows frequency distribution of the maximum, inside corrosion rate (presumption lower bound value) at the first inspection of each GF coated Tank of which coatings were used 5 to 13 years (8.4 years on the average) after construction. On the other hand, Figure 2.4.10 is showing frequency distribution of the maximum, inside corrosion rate (presumption lower bound value) at internal inspection of 28 Tanks coated with Coating Guide which were used for about ten years. 276 Tanks are analyzed in Figure 2.4.9 and of which coating were constructed either by equal to or more than the specification of Coating Guide or by the one that didn't meet Coating Guide.

and the coating is the one

Because the one to show the high corrosion rate (for instance, one to exceed 0.3mm/year) is seen in Figure 2.4.9 and is not seen in Figure 2.4.10, the coating constructed with Coating Guide can be said that the prevention function to inside corrosion is high



図 2.4.8 設置時からGFコーティングが施工されたタンクの開放ごとの内面腐食履歴の例



図 2.4.9 GFコーティングが施工されているタンクの1回目開放時の内面腐食速度

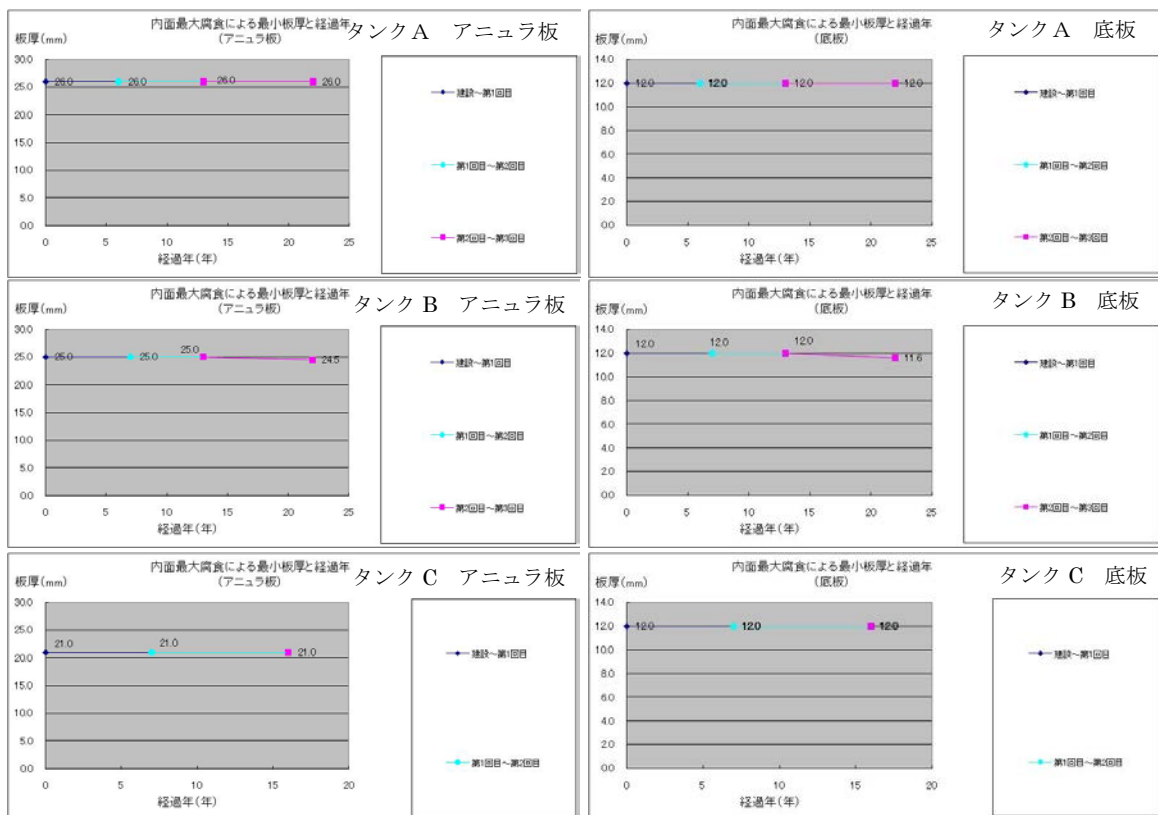

図 2.4.10 コーティング指針によりGFコーティングが施工されているタンクの内面腐食速度

(6)Coating Guide

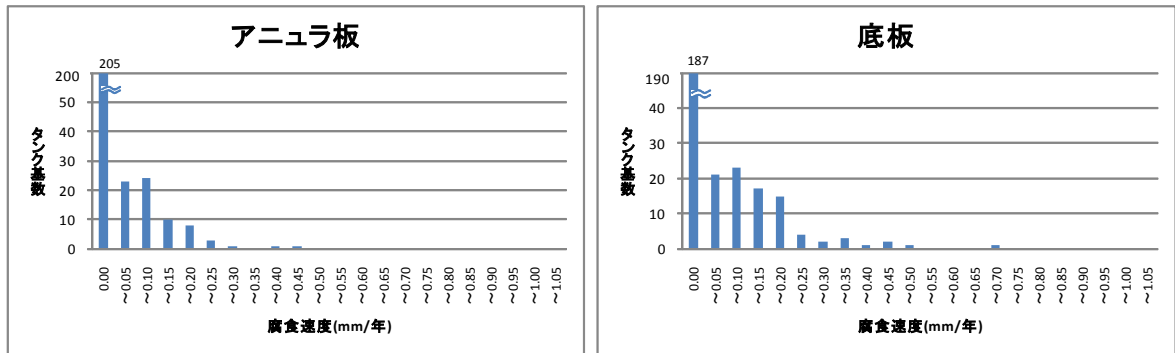
Necessary requirements and the test methodology are provided in Coating Guide about the following matter to assume the coating that doesn't flake off easily.

- The selection of the coating that is appropriate for content and the storing temperature: It specifies for the coating material with the resistance to oil because the paint film is deteriorated easily unless the painting material that adjusts to contents and the storing temperature is used.
- The quality of the material: The resistance to solvent attack and impact resistance, etc. are confirmed by the materials test etc.
- The range of construction of the coating: It specifies for the range of construction because non-painting part is corroded easily as for the part (bottom and lower side of the shell) where moisture etc. collect if everything is not painted. It is confirmed by the visual inspection.
- The thickness of the coating: It is specified because it cannot carry out the prevention function of corrosion if the easiness etc. for moisture to penetrate change according to the thickness of the paint film, and there is no enough thickness. This is confirmed by

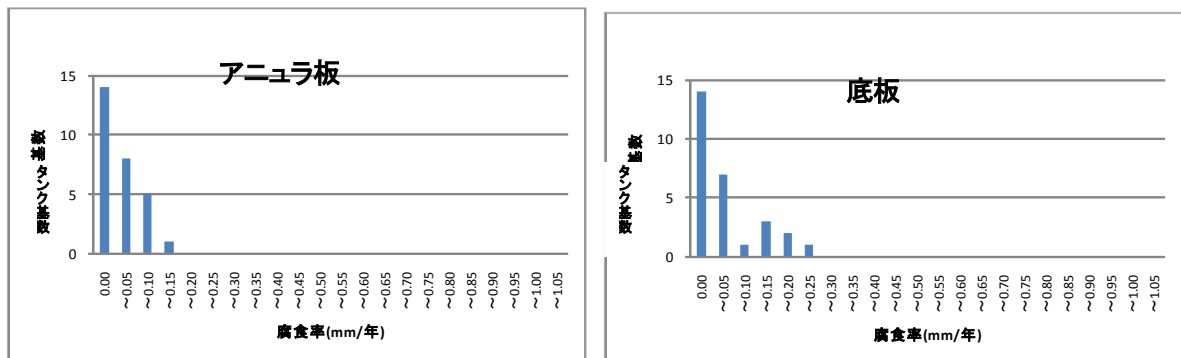
the film thickness test and the pinhole test.

- The construction environment (temperature and humidity, etc.): It is specified because curing shortage owing to the construction environment causes insufficient adhesion strength of the paint film when there are a dewfall etc. The temperature and the humidity of paintwork are observed and recorded.
- Surface Preparation (surface-roughness and extent of rust removal): Proper surface preparation is necessary to secure adhesion strength. It is confirmed comparing with the standard.
- Extent of cleaning after surface prepared: Surface cleaning is necessary because adhesion strength is insufficient when there is foreign body.
- The mixture and the management of the material: It is specified because the strength shortage of the paint film if neither an appropriate mixture nor management are performed.
- Application timing of the primer: It is specified because the adhesion strength is insufficient if the surface is oxidized after surface treatment.
- The method of processing the weld: It is specified to prevent thickness shortage of the paint film in the weld etc.
- Ventilation under painting and dry time of paints: It is specified to secure strength of the paint film. It is confirmed by the pinhole test.

According to (5) GF coating constructed in accordance with Coating Guide has a high prevention function to inside corrosion though the population parameter is few at present. The check management for the coating is necessary to maintain a function concerned because the inside corrosion prevention function decreases along with the aged deterioration. It is necessary to repair because there is the possibility of the tear of the part and flaking off during the next use period when the swelling is found in case of internal inspection. Moreover, when the life of the paint film is passed, it is necessary to note the paint film to the life because fear that the flaking off part appear if large range is deteriorated increases and fear that the corrosion rate grows in the part where the flaking off appears is caused. The content of Coating Guide is necessary and sufficient and the point that should be changed is not especially found even if compared with a present finding. It is thought that it is important to improve the effectiveness of the execution management through the education etc. from there was a case where the swelling is widely caused by ventilation shortage though it follows the Guide in the management record.

2.4.3 Comparison between general idea concerning wet corrosion and tank inside corrosion case investigation

A past case research into inside corrosion of Tank bottom plate was done in detail. There was a case where the penetration hole was caused by inside corrosion though the number was little in that, and the corrosion rate had the one to exceed 2mm/year by presumption. The inside of Tank is under wet corrosion environment because it touches the water including electrolyte or the sludge which contained them, and corrosion is caused by an electrochemical action chiefly. In this paragraph, after a general idea concerning the wet corrosion is described based on the stated above, the case investigation result concerning tank inside corrosion is analyzed.

(1) General idea concerning wet corrosion

Corrosion is caused by pairing with the anode oxidation reaction that is the dissolution reaction of the metal and the cathode reduction reaction of the oxidant. Since these reactions may accompany an electronic transfer at interfaces between the electronic conductors such as the metal and the ion conductors of solution etc. without fail, the reaction speed is shown as a current that flows in the interface (Figure 2.4.11). In the simplest reactive mechanism, a linear relation consists between the logarithm of the absolute value of this current and the potential of the metal (It is noted that the inclination of the anode reaction and the cathode reaction is opposite, and shape is various according to patterns of reaction, and the range where this relation consists is very much limited in the real system). On the condition that the addition of the current value related to the anode reaction and the cathode reaction becomes zero from the principle of an electric neutral, the intersection of the current-voltage property of both becomes corrosion potential when the corrosion reaction progresses in the natural state. Well, the single meaning current-voltage property in which the corrosion reaction speed is decided doesn't exist theoretically and is influenced by various physicochemical environmental factors. The anode reaction corresponds to the corrosion dissolution speed of steel, and it changes greatly by the character of the temperature, pressure, and the solution, states of flow, and states of the surface film etc. besides potential. On the other hand, the cathode reaction strongly depends on the property (kind and density of the oxidant) on the solution side mainly though it receives the influence of various factors as well as the above-mentioned.



図 2.4.11 均一腐食反応に対する一般的な考え方

Well, the corrosion thinning observed after a certain period can be basically presumed by integrating an occasional corrosion rate for the period if a time change in all the influence factors for Tank during the period can be completely obtained. However, it is realistically impossible to understand these carefully because spatial distribution exists in the influence factor in a vast steel structure like the crude oil tank. When this spatial non-uniformity is made fixed for a long time, the severe local corrosion occurs by the anode part's fixation. In this case, since the polarized state of a local anode and a local cathode differs, it is necessary to understand completely the total four current-voltage properties, namely those of the anode and cathode of the local anode and those of the anode and cathode of the local cathode to describe the corrosion rate strictly. Therefore, the presumption of the corrosion rate becomes far more difficult than a simple corrosion system. In addition, understanding of the corrosion action for a long time will be thoroughly difficult further, since the area ratio and shape of the current-voltage property where the anode and cathode reaction have happened change as time passes because of the influences of the time changes etc. of not only environmental factors but also surface state

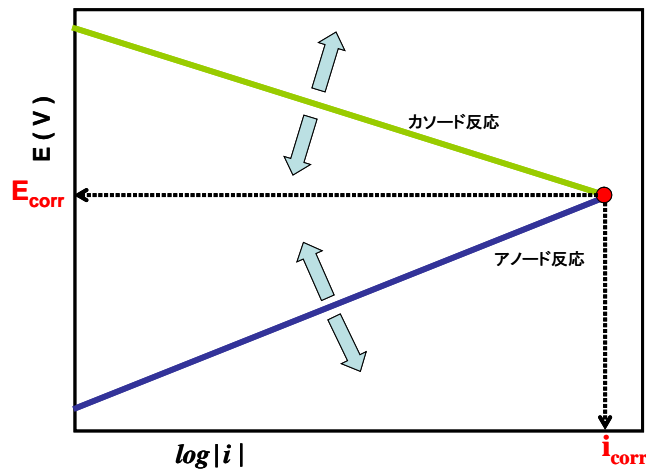

図 2.4.12 局部腐食に対する一般的な考え方

(2) Comparison with case investigation result

Though it cannot be accurately known of the current-voltage property for Tank during service period as described in the preceding paragraph, the case investigation results are evaluated by adopting⁶⁾ the document value of the current-voltage property of steel (Figure 2.4.12) in the neutral solution of normal temperature (25°C) as a current-voltage property of the local anode and assuming that this doesn't change for Tank during the period. The tank bottom plate has come in contact with drain water similar to seawater and sludge. In general, general corrosion rate of steel on the environment (excluding splash zone and tide belt)⁷⁾ is around 0.15 mm/y. As there is a case in which drain water pH shows around 3 depending on the influence of oil kind, general corrosion rate is examined under atmospheric saturated condition and pH= 3 and understood about 0.33 mm/y⁸⁾.

If there is no corrosion promotion action by a local cathode, it is clear from the figure of the current-voltage property that a corrosion rate does not reach to such a value as that exceeding 2mm/year which was presumed in the case research to cause at the flaking off part or the defect part where the coating doesn't exist by becoming a local anode. The promotion factor includes the formation of the oxygen concentration cell by piling up of the rust layer where the oxygen penetration is controlled on a local anode and the action as a local cathode of the flaking off part or the coating deterioration part (cathode swelling) around the defect part. It is guessed that the local cell action that the local anode changed to about as much as 0.1V higher potential was caused according to Figure 2.4.13.

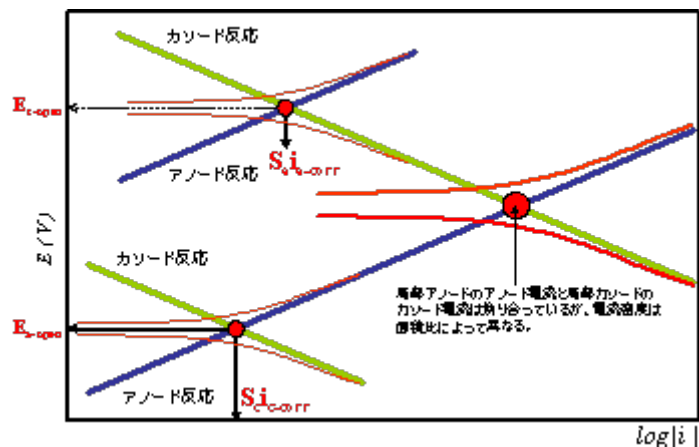

図 2.4.13 常温 (25°C) の中性水溶液中における鋼の電流電圧特性

(注：ここでは、鋼の内部分極曲線と同等であるとする。)

Next, in the case research, in consideration of having often presented a big corrosion rate by the local corrosion that was caused between the flaking off part of the coating that originated in defective construction which became the local anode and the part in the surrounding where the deterioration such as the flaking off was not but swellings was caused became a local cathode, this corrosion is evaluated by assuming a simple model (Figure 2.4.14).

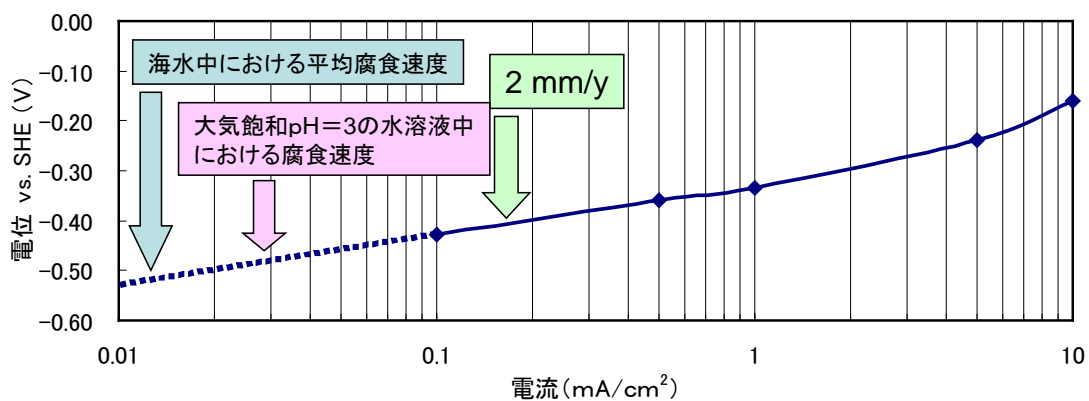

図 2.4.14 内面コーティングに欠陥及び剥離部が存在する場合の局部腐食による侵食促進作用を単純化したモデル

First of all, potential difference of an open circuit ($\Delta E = E_{c-open} - E_{a-open}$) of the local anode and the cathode becomes the driving force of the local cell action. Here, to the value 0.5V is assumed which was observed as acid-base battery in the concrete macro cell corrosion etc..⁹⁾ The current that flows between a local anode and a local cathode is decided by this driving performance and the total resistance included in the local battery circuit, and this can be considered to be a corrosion promotion by the local corrosion.

In the resistance element included in this circuit, the influence of interfacial resistances (R_a, R_c) of a local anode and a local cathode which are non-[o-mikku] resistance element depending on potential are not considered here. Among these resistance elements, R_{metal} that is the resistance of a metallic body can usually be disregarded because it is very small. Moreover, it is thought that the current value is almost ruled by interfacial resistance R_c of a local cathode and resistance element of the coating R_{coat} , considering that the drain water resembles seawater, the rust layer has porous quality and its ionic permeability is very high compared with the coating, and the interfacial resistance is b

presumed to be small because the local anode has been activated.

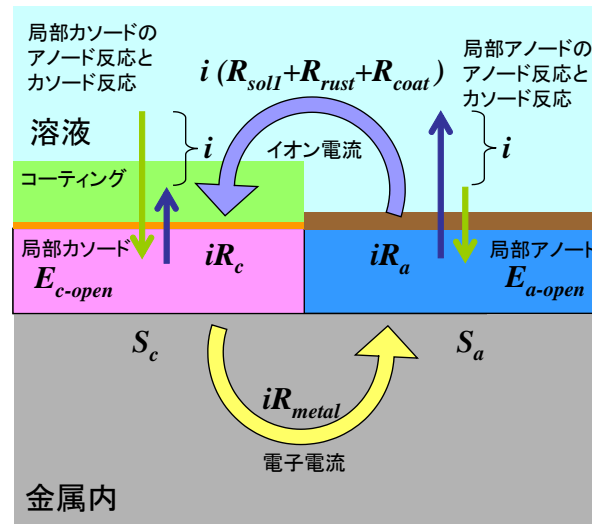
Therefore, it is understood that the value of $R_c + R_{coat}$ is only $4k\Omega$ by simple calculation in the case that the invasion speed of defect part of $\phi 10$ mm is promoted from 0.15mm/year to 2mm/year at the corrosion rate in general seawater. It is guessed that the coating of the part that is a local cathode hardly demonstrates the environmental interception performance in this situation, considering that the direct current resistance of non-defect part becomes far more than several hundred $M\Omega$ though it is difficult to discuss more than this due to the uncertainty of the cathode area.

3) Summary

In the case of the investigation of penetration through the bottom plate due to inside corrosion of the crude oil tank, the case presumed to have presented the corrosion rate that exceeded 2mm/year was admitted. It is guessed that a strong corrosion promotion action by the oxygen concentration cell by the formation of [sabikobu] or by the formation of a local cathode of the undercoating corrosion was caused at surroundings of the penetration hole that became a local anode. The trouble was often caused in defective construction part and its circumference according to the case research. However, since it occurred in the tank which was used for a long period, there was a case with the possibility that the existing coating part that was not admitted trouble at latest opening for inspection and had been used continuously also took part as a local cathode, too. The deterioration of a peripheral coating is promoted if the defective construction exists. Therefore, it is thought that it is necessary to take account, especially, that there is a possibility of causing the corrosion of acceleration which cause the penetration hole in the case that the flaking off of the coating by defective construction is generated in the repair paint film etc., the surrounding of the hole becomes a cathode in the tank where the coating usage period is long and is overall deteriorated.

On the other hand, it is thought that it is a general deterioration scenario to pass the process that the swelling is caused gradually because of deterioration for the use period, this progresses further, the deterioration arrives at the undercoating corrosion and finally the swelling is destroyed and intense corrosion is caused, if it is a coating to which a constant execution management is performed¹⁰⁾. However, the number of investigation cases might be little, and a typical case where a big corrosion rating was presented according to this deterioration scenario was not extracted this time. It can be said that swell of the coating is not instantly destroyed will suggest that the growth of the local corrosion which brings a rapid invasion is controlled since the resistance element (environmental interception) of the coating functions as a loose lining.

References cited

- 1) Hazardous Materials Safety Techniques Association: Investigation examination report concerning cause of leakage accident at the outdoor storage tank facilities of K factory of N oil terminal Ltd. October 1985
- 2) Hazardous Materials Safety Techniques Association: investigation society report concerning bottom corrosion of coating tank, November 1997
- 3) Hazardous Materials Safety Techniques Association: Investigation advisory committee report concerning cause of crude oil leakage accident from outdoor storage tank facilities November 2001
- 4) O refinery of S Ltd. special committee for accident measures: Accident report concerning to separation water leakage from 003 # crude oil tank at O refinery, June 17, 2003
- 5) K refinery of T Ltd.: Cause investigation report book concerning No.19 oil tank leakage accident, September 2006
- 6) I. Matsushima: Localized Corrosion, Elsevier Applied Science, p. 31, 1988
- 7) Gorou Ito: Corrosion science & corrosion engineering, Corona company, p.360, 1977
- 8) Edited by Japan Society of Corrosion Engineering: Introduction to material environmentology, Maruzen, p.145, 2002
- 9) H.H.Yurik & R.W. レヴィー: Corrosion reaction and its control (the third edition), Industrial books, and p.249,1989
- 10) High-pressure institute of Japan: Investigation research report concerning corrosion technology and safety assessment of oil storage tank, p.189, March 1995

2.5 The back side corrosion of tank bottom plate

To understand the realities of the progress of back side (ground side) corrosion that was one of the deterioration factors of Tank, the result of the measurement ("Continuous plate thickness measurement. ") by a new technology that was able to measure the back corrosion in detail was collected and analyzed. Refer to 2.6.5(5) for the measuring method of the depth of the back corrosion of the tank bottom plate.

2.5.1 Distribution and shape of the back side corrosion

Figure 2.5.1 shows the result of the continuous plate thickness measurement to three Tanks. Blue shows the area where corrosion hardly progresses, and the area where corrosion is comparatively advanced is shown in yellow and red (The remarkable one is seen in the rectangle). White shows the defective part with the prop protection board etc. of the floating roof. It is understood that the corrosion situation of the tank bottom plate is different in each Tank and it is not the same in one Tank from this figure.



図 2. 5. 1 連続板厚測定によるタンク底部板の板厚分布の例

As for the bottom plate in the tank in the right of Figure 2.5.1, the graph of Figure 2.5.2 is a histogram of the plate thickness measured by the continuous plate board thickness metrology. A horizontal axis shows the measured plate thickness, and the ordinate shows the numbers of measurement points (it is almost proportional to the area). The following is understood from this figure.

- The majority of bottom plate thickness is in the range from 11.3 to 12.3mm. (measurement points within the range of concerned: About 70 million points)
- The part in the range from 7.0 to 9.0mm in plate thickness exists though the distribution ratio is small. (measurement points within the range of concerned: About 300 points)

c. There is a possibility of not corroding in the most of the bottom plate too much even in this case at which the spill accident from Tank bottom occurs because the penetration hole becomes empty by corrosion which advances locally as shown b.

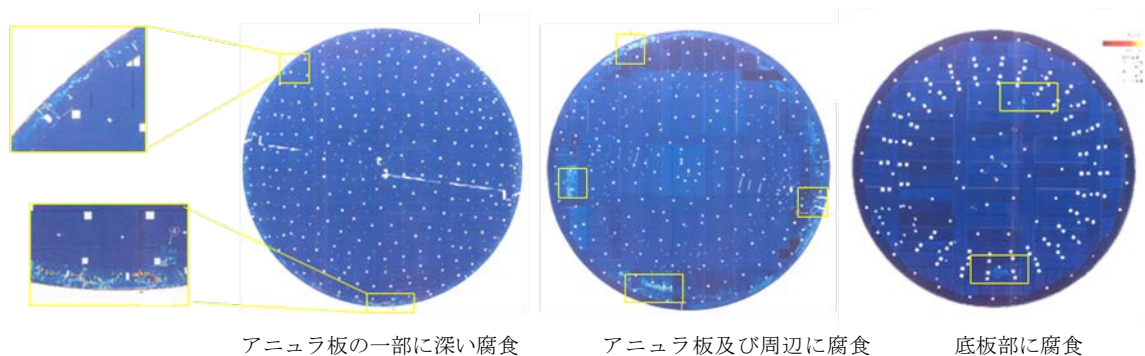
Figure 2.5.3 is showing of the corrosion shape of the tank bottom plate from the continuous plate thickness measurement data. It is understood that how for corrosion to progress is various with respect to its extension, depth, and the distribution, etc. and presuming in the future of corrosion, it is necessary to consider the uncertainty for how for corrosion to progress. The example of the cross sectional shape of corroded part was shown in Figure 3.3.5.

It was likely to exchange it at the opening time followed without measuring the thickness of the plate with an intense corrosion. In this case, the corrosion depth was not understood. As such, there were constant cases that were substituted without measuring the thickness though there was big corrosion. They have become obstacles in understanding realities and analyzing the data.

The one due to defect by striking was included while the one of the plate substitution without measuring the inside corrosion depth* and the case that the corrosion rate could not calculated because of the uncertainty of the details of the repair were excluded in calculating on average corrosion rate.



図 2.5.2 連続板厚測定によるタンク底部板の板厚のヒストグラムの例



図 2.5.3 連続板厚測定データに基づくタンク底部板の腐食形状の例

2.5.2 Change of the back side corrosion rate as year passes

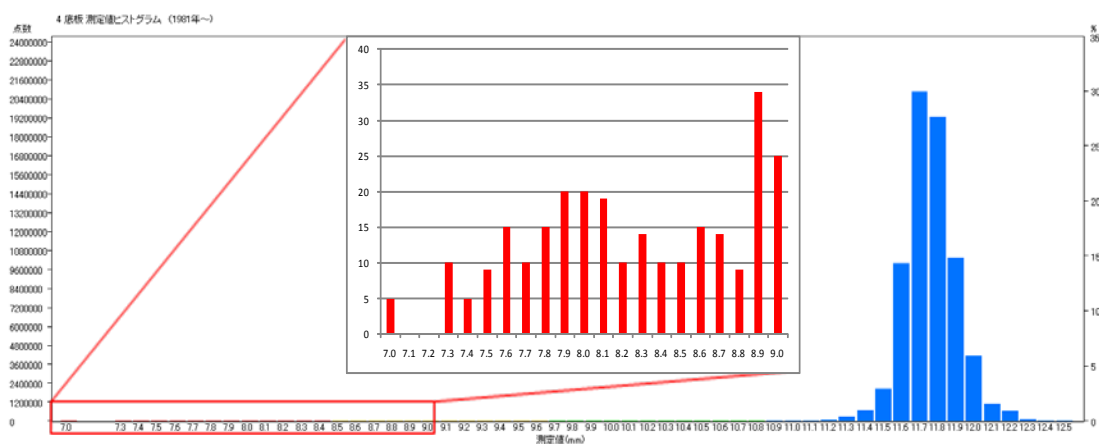
About the new law Tank (What used to examine 3.2. reference 2)) in which it was reported that the back corrosion depth was large, Figure 2.5.4 is a display of the back corrosion rate of each individual Tank by the difference of the frequency of opening for inspection. The maximum corrosion part was assumed to be the same as that of last time opening and in calculating the corrosion rate the corrosion depth difference measured by the fixed point measurement between this opening and last opening was

divided by the period from this time to last time. The result of calculation is not so dependable because the measurement density is low by a fixed point measurement. And it is not the one to show the tendency to all tanks because neither the one of which corrosion depth was small nor the one of which plate was substituted without measuring the corrosion depth* was included on the calculation.

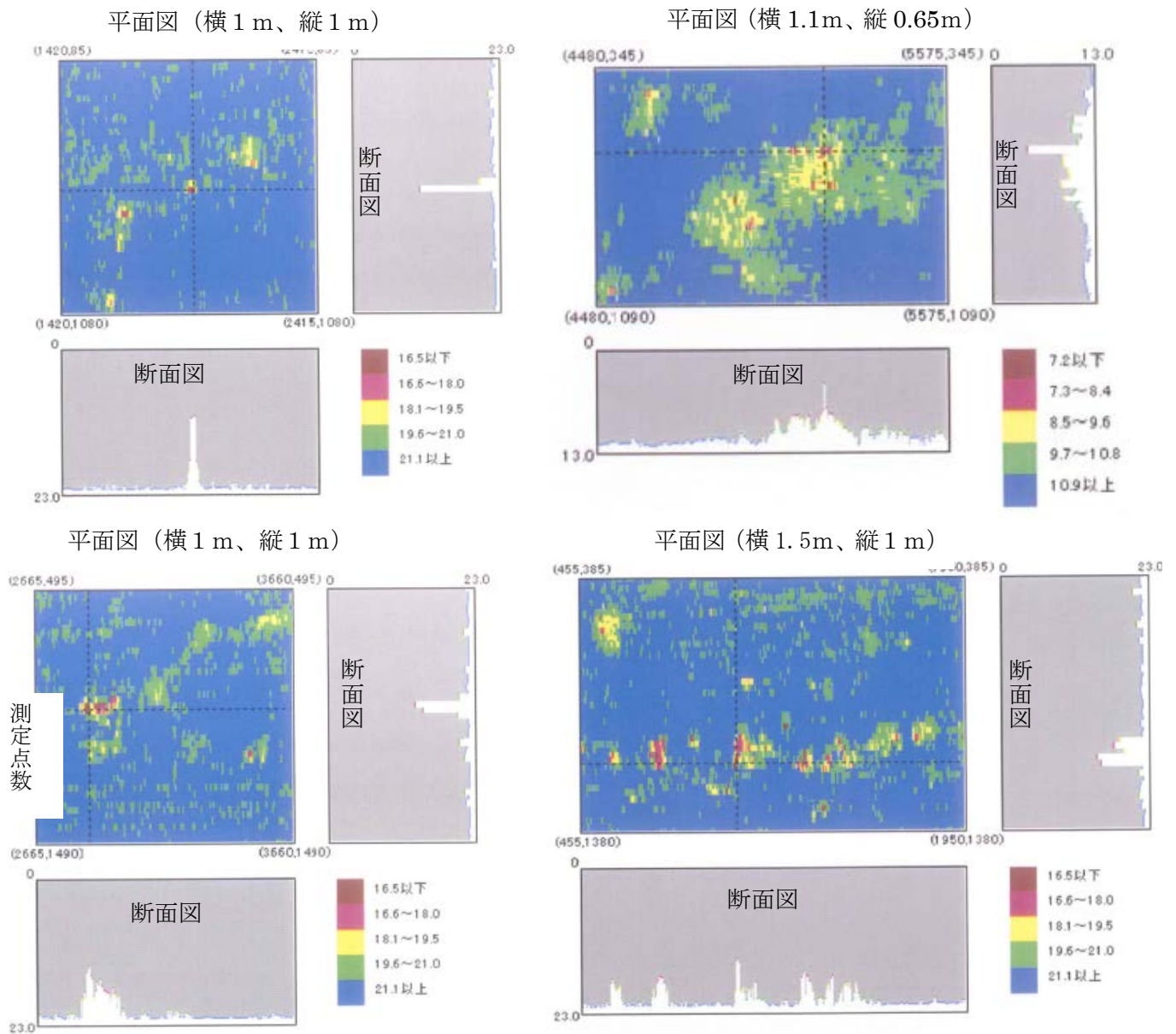
* Since there were constant cases that plates were substituted without measuring its thickness though there was big corrosion on it. They have become obstacles in understanding realities and analyzing the data.

It is difficult to find a constant tendency to the appearance situation at the back side corrosion rate of each time and to get the upper limit of the change as long as Figure 2.5.4 is seen. It is noted that the calculated data are not necessarily to be the maximum back side corrosion rate because it is the one calculated based on the result by the fixed point measurement.

Such factors as the deterioration in the back side corrosion prevention measures, the deterioration in the preventive measure for rain water inflow, the storing temperature change and changes in the contact situation with the bottom plate etc. are actually considered as the cause of the back side corrosion rate changes.

Examining the characteristic about Tank of which back side corrosion rate is large, it is understood that the back side corrosion rate of Tank under normal temperature is about almost less than 0.4 mm/year while it might become large in the warmed Tank.

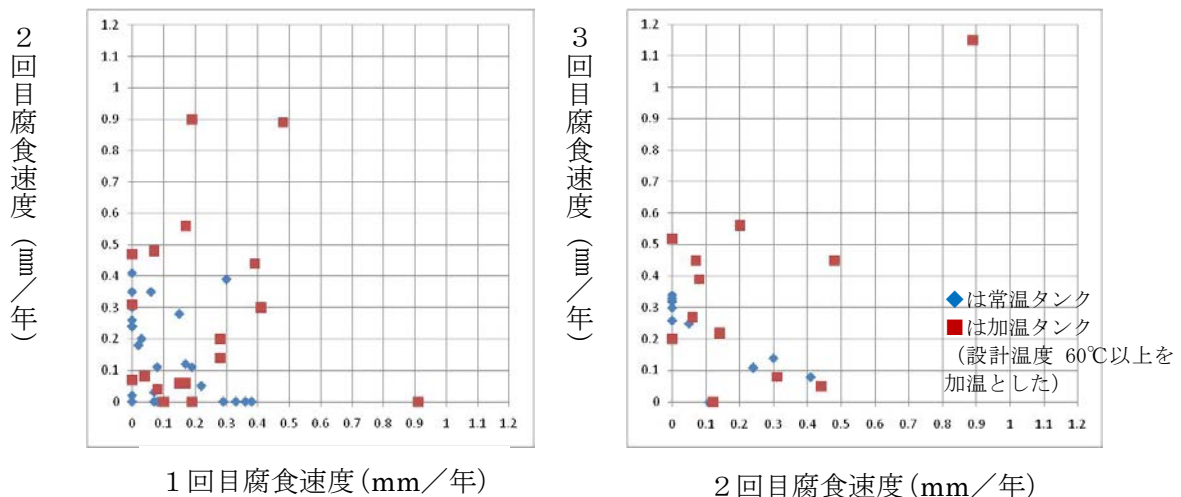

* 腐食深さが小さかったもの及び腐食深さが測られずに板替えされたものは含まれていない。
* 定点測定による腐食率である。

図 2.5.4 裏面腐食深さが大きかった履歴のあるタンクの1回目開放時の裏面腐食速度と2回目開放時の裏面腐食速度(左)及び2回目開放時の裏面腐食速度と3回目開放時の裏面腐食速度(右)

Figure 2.5.5 and Table 2.5.1 show averages of the maximum back side corrosion rate calculated from the maximum back side corrosion depth of each new law Tank based on the number of Tanks of which data were obtained at each frequency of opening. Figure 2.5.6 shows the distribution of the number of Tank at each back side corrosion rate. The back side corrosion rate used for these was obtained according to the maximum back corrosion depth based on the fixed point measurement, and so its dependability is not high because the measurement density is low. It is understood that the ratio of the number of Tank of which back side corrosion rate is not 0 and which have the big back side corrosion rate has increased as the number of opening for inspection increases.



表 2.5.1 開放回数に対する裏面腐食速度の平均値及び最大値並びに対象タンク基数

部位	開放回	1 回目	2 回目	3 回目
アニュラ板	平均値 (mm/年)	0.055	0.056	0.069
	最大値 (mm/年)	1.3	0.56	0.56
	タンク基数	571	448	246
底 板	平均値 (mm/年)	0.056	0.040	0.057
	最大値 (mm/年)	1.2	0.90	1.1
	タンク基数	531	425	275

(データ算出の条件)

- 板替えや補修内容不明で裏面腐食速度が求められないものを除いた。
- 開放時に見つかった最大裏面腐食箇所が、前回開放時の補修後の最大裏面腐食箇所であったと仮定し、開放間隔年数により腐食速度を求めた。
- 使用したデータは定点測定を実施したタンクのみを抽出した。
- 裏面腐食履歴データは危険物保安技術協会が保存しているもので各タンクの最も古いデータを1回目とした。

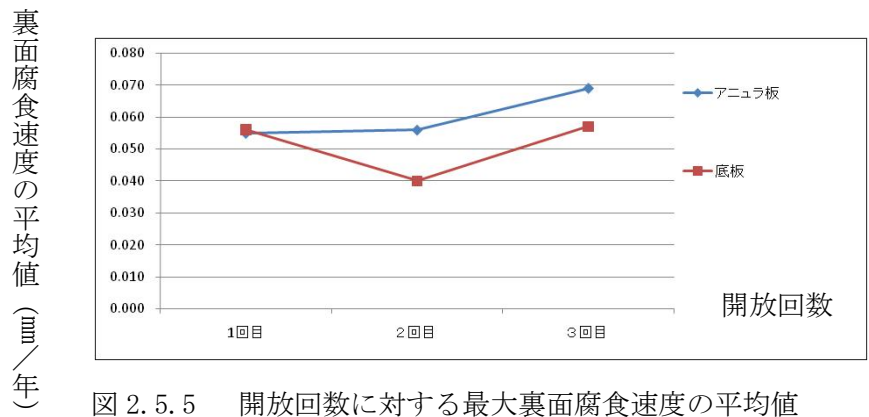

図 2.5.6 各開放時の最大裏面腐食速度とタンク基数

In order to analyze the relation between the frequency of opening and the back side corrosion rate of Tank in accuracy, the Tank where there are results of three or more in the past opening and all the back side corrosion data in each opening was obtained, has been extracted (Figure 2.5.7 and Table 2.5.2) from the data analyzed in Figure 2.5.6. Figure 2.5.7 is showing distribution of the number of Tank at each back side corrosion rate, and Table 2.5.2 is showing an average on the maximum back side corrosion rate obtained from the maximum back side corrosion depth in each opening of Tanks.

Though no great disparity is seen in the mean value between the 2nd and 3rd times opening, the mode value shifts from 0 at the 3rd times opening when the number of Tanks distribution in the histogram is seen, and it is thought that the back side corrosion has accelerated according to the age passed. As the factors, the deterioration in the back side corrosion prevention measures, the deterioration in the preventive measure for rain water inflow, the storing temperature change and changes in the contact situation with the bottom plate etc. are considered.

Since the back side corrosion rates are showing the tendency to be still distributed in about 0 at the third times opening, it is evaluated that the degree of acceleration of back side corrosion according to the passing age is gradual compared to that of inside

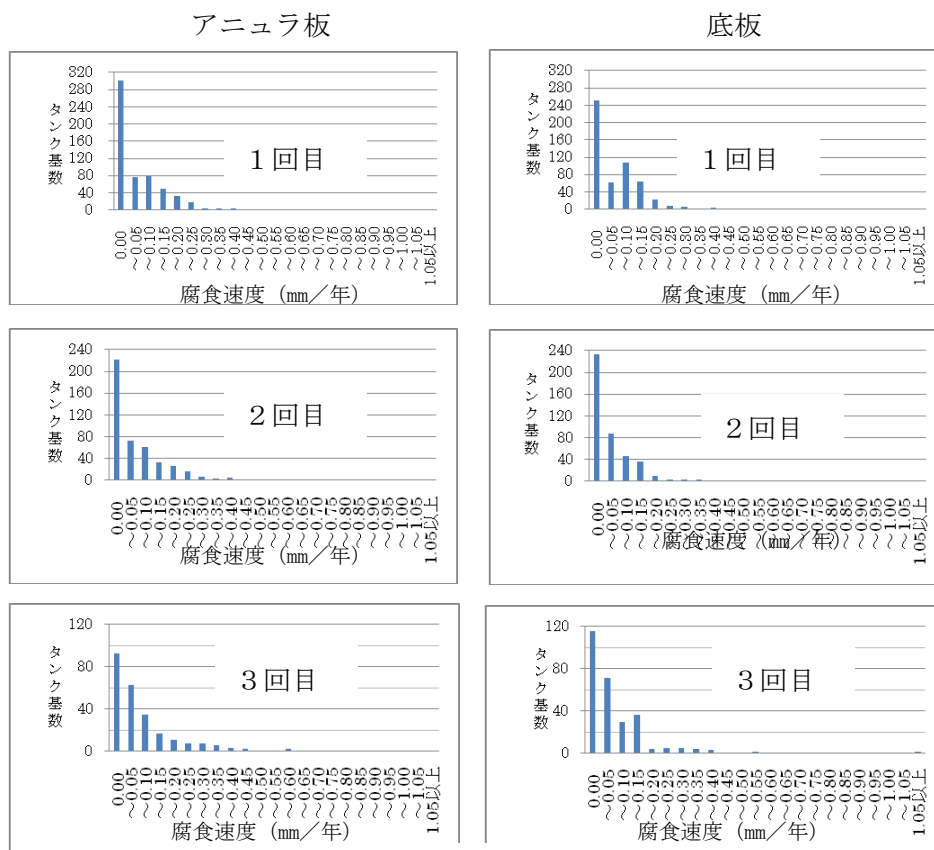
corrosion shown in Figure 2.4.5.

アニュラ板

底板



図 2.5.7 3回以上の開放実績があるタンクの各開放時の最大裏面腐食速度とタンク基数

表 2.5.2 3回以上の開放実績があるタンクの開放回数に対する裏面腐食速度の平均値及び最大値並びに対象タンク基数

部位		第1回開放	第2回開放	第3回開放
アニュラ板	腐食速度の平均値 (mm/年)	0.031	0.073	0.066
	腐食速度の最大値 (mm/年)	0.39	0.48	0.45
	タンク基数	158基	158基	158基
底板	腐食速度の平均値 (mm/年)	0.044	0.056	0.071
	腐食速度の最大値 (mm/年)	0.48	0.9	1.14
	タンク基数	129基	129基	129基

Figure 2.5.8 shows the result of analysis ¹⁾ of the tendency to the corrosion rate obtained from the corrosion damage case with a metallic material in the pressure equipment of the oil refinement etc. The corrosion rate has been divided as follows according to the corrosion mechanism.

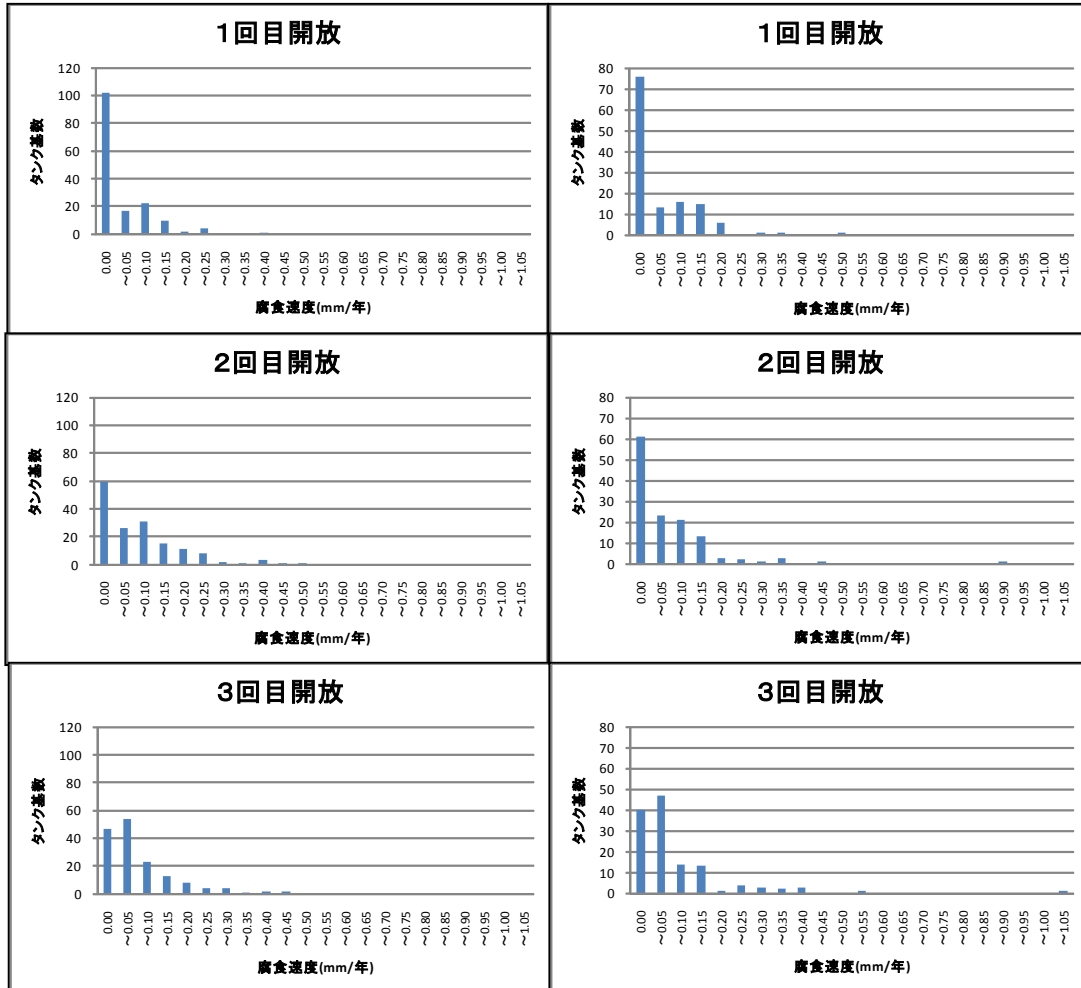
- I Corrosion speed 0.15-0.3mm/year: Corrosion because of general comparatively mild environment
- II Corrosion speed 0.3-0.5mm/year: Corrosion of underground, corrosion in which chlorine, salinity, and H₂S influence it, and stress corrosion cracking
- III Corrosion speed 0.5-4.0mm/year: erosion/corrosion

The division between I and II is ruled by the environment and the material, and said that original division is vague.

When the part where continuous distribution is done is seen, the back side corrosion rate of the tank shown in Figure 2.5.6 is roughly within 0.45mm/year though its dependability is not high because the measurement density by the fixed point measurement is low. In addition, from the corrosion mechanism that is thought, it can be said that the corrosive environment of the back side of Tank bottom plate is I and II in a lot of Tanks.

However, the one that the corrosion rate is large is partially seen, and it is necessary to note the possibility that the corrosion rate grows on the back side of the tank bottom because it is guessed that there is the one that becomes an abnormal environment, too.

Reference Cited

1) Hideo Kobayashi and Shozo Yanagida: High-Pressure Gas vol.35, No.3 , p.23-33 (1998)



図1 腐食損傷事例の公称厚さ (mm) と使用年数 (年) の関係 (炭素鋼/合金鋼)

図 2.5.8 腐食損傷事例の公称厚さと使用年数の関係¹⁾

2.6 Factor analysis on accident of outdoor storage tank facilities

2.6.1 Typical accident case and accident case occurred in 2010

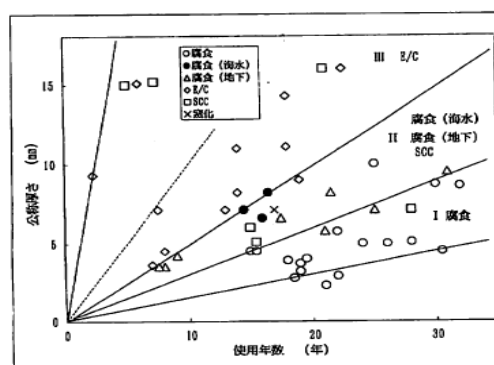
Information on the accident obtained from the accident cause report etc. on two spill accident cases from the bottom occurred in 2010 and five main cases of the spill accident from bottom in the past is brought together as follows.

(1) Crack of weld by uneven settlement¹⁾

a. Accident outline

The weld connecting the shroud to the annular plate was broken because of uneven settlement of the base and the crude petroleum 42,888 kl in the tank flowed out, of which about 7,500 to 9,500 kl spilled out to the sea and about 1/3 of the Inland Sea was polluted in the refinery in Kurashiki City, Okayama Prefecture.

b. Date of occurrence; It is about 20:40, December 18, 1974.

c. Outline of tank

- form; fixed roof type
- size; 52.307m in diameter×23.67m in height
- capacity; 48,000 kl
- contents; heavy oil
- material; annular plate HW50, thickness 12mm, bottom plate SS41 thickness 9mm

d. Accident cause

The weld broke because the space was formed between annular plate and the ground near shell plate, and a partial crack of the weld connecting the shell plate to the annular plate was caused, and dangerous articles flowed out.

(2) Crack in weld due to earthquake in annular part thinned by corrosion²⁾

a. Accident outline

The weld where shell plate and the annular plate were connected broke in three tanks, and dangerous article 68,100 kl stored flowed out and exceeded oil retaining dike in the tank surroundings and moreover it averted and scour the ground under the dike and flowed into factory premises and of which 2,900 or 5,000 kl flowed out to the sea by Miyagi-ken-oki Earthquake in 1978, at the refinery, in Sendai City, Miyagi Prefecture.

b. Date of occurrence; 17:14 ,June 12, 1978 (earthquake occurrence)

c. Outline of tank; (name of tank T-217, T-218 and T-224).

- Form; fixed roof type
- size; 43.588m in diameter ×21.855m in height (T-217,T-218)
37.776m in diameter ×21.855m in height (T-224)

- capacity; 31,500 kl (T-217,T-218) , 23,700 kl (T-224)

- Contents; C heavy oil (T-217,T-218), the decompression light oil(T-224)

d. Accident cause

It is thought that the tank hit by a considerably big seismic ground motion of Miyagi-ken-oki Earthquake. Moreover, the backside of annular plate was corroded entirely. It is thought that the penetration crack in the weld and no penetration crack spread by such a factor, and they it connected mutually and broke.

(3) Crack of bottom plate weld³⁾

a. Accident outline

The lap joint weld between the bottom plates broke in the tank, and crude oil flowed out to the drainage trench by 50 kl at the refinery in the Yokohama city.

b. Date of occurrence; about 12:30,February 4, 1979

c. Outline of tank

- Form; float roof type

- size; 69.765m in diameter × 15.29m in height

- capacity; 50,000 kl

- Contents; crude oil

- material; annular plate HT60, thickness 12mm, bottom plate SS41 thickness 8mm

[Anyura] board: Material board thickness 12 bottom plate:

d. Accident cause

Lap joint weld was broken in bottom plate by synergy effect of local subsidence of base, corrosion of fused spray deposit, and defect in weld.

(4) Penetration due to inside corrosion⁴⁾

a. Accident outline

Naphtha flowed out by the penetration hole due to the inside corrosion caused in the bottom plate in the tank. It was perceived 23 days after the outflow beginning. During the period it infiltrated into the ground, and flowed out to the river through underground water. The amount of the spill was presumed as 80 kl. Digging was done between the river and the tank and the oil inflow to the river was stopped by pumping underground water, at the refinery in Joetsu City, Niigata Prefecture.

b. Date of occurrence; December 7, 2005

c. Outline of tank

- form; fixed roof type

- size; 15.490m in diameter × 13.655m in height

- capacity 2,400 kl
- Contents; heavy naphtha
- material ; annular plate SS41, thickness 6mm, bottom plate SS41 thickness 6mm

d. Accident cause

Flaking off of the inside coating of tank was caused in the construction defect part of a bottom plate, and the pitting corrosion occurred from there. The penetration hole (about 10mm in diameter) was formed, and the outflow began. The oil slick was discovered in the river, and accident was perceived on December 31. When the spill start date was presumed from the change on the liquid level, it was assumed December 7, and the amount of spill in the period was presumed as 80 kl later. The electrolytic protection was set up, and there was little back side corrosion in the vicinity of the penetration hole.

(5) Penetration due to the back side corrosion⁵⁾

a. Accident outline

On the back side of bottom plate of tank, dewfall was caused and the back side corrosion occurred. The 200 l of styrene flowed out from the water pulling out hole installed in the ring-type base, in Otake city, Hiroshima Prefecture.

b. Date of occurrence; July Seven, 2003

c. Outline of tank

- Form; fixed roof type
- size; 14.700m in diameter × 13.000m in height
- capacity; 2,000 kl
- Contents; styrene

d. Accident cause

Since the dewfall was occurred, it became a moist environment on the back side of the bottom plate under the normal temperature management, and owing to the deterioration of asphalt sand, chloride contained was concentrated in the sticking part with the bottom plate. In addition, it is presumed to have developed into the abnormal corrosion as the differential aeration corrosion and the acid caustic action came in succession, too.

(6) Spill accident case due to weld crack in bottom plate⁶⁾

a. Accident outline

Cracks occurred at the bottom plate weld in tank, and jet fuel leaked. The amount of spill was calculated as 0.14 kl at refinery in Ichihara city, Chiba Prefecture.

b. Date of occurrence; 16:50, January 24, 2010

c. Outline of tank

- form; floating roof type
- size; 67.37m in diameter × 18.24m in height
- capacity; 51,252 kl
- contents; jet fuel (the fourth kind second oil)

d. Accident cause (tentative)

When tank was opened and the leakage part was specified, the coating of about 400mm length and the crack of the bottom plate were found out in the neighborhood of the lap welding line and the patched plate for the roof support. It was presumed as a crack by the low cycle fatigue at the office.

(7) Outflow accident case due to the back side corrosion

a. Accident outline

The worker found out the lubricant about 60 kl (presumption) to leak from the outdoor storage tank facility. The leak amount from the tank was estimated about 60 kl when examining the receiving / shipping record though the leakage amount of lubricant from the tank bottom was regarded as about 2 kl, at the refinery in Kainan-city, Wakayama Prefecture.

b. Date of occurrence; at noon, April 5th, 2010 (perception)

c. Outline of tank

- form; fixed roof type
- size; 21.3m in diameter × 15.225m in height
- capacity; 4,900 kl
- contents; The lubricant (the fourth kind fourth oil) (specified combustible when the accident occurred)

d. Accident cause

The penetration hole of 5cm × 6cm was found out in the center part of tank bottom plate. The internal inspection was executed in 2002, and bottom plate coating (epoxy resin) construction was executed. The inside was hardly corroded, and it is thought that corrosion from the back side of the bottom plate progressed chiefly. It was guessed that there was little remaining plate thickness in the area of about 15cm in the diameter around the hole concerned. The oil kind of contents was changed, namely from light oil to the lubricant in 2007 and the heating pipe was installed.

2.6.2 Aged deterioration and accident factor of tank

Figure 2.6.1 shows the schematic figure of the factor of aging deterioration of the tank. The following three factors are thought as the main causes of the spill accident from the bottom of the tank (the factor of aging deterioration).

- Thinning due to inside corrosion (preceding clause case (4))
- Thinning due to the back side corrosion (preceding clause case (2), (5), and (7))
- Deterioration in weld by earthquake and repetitive load (preceding clause case (2) and (6))

Moreover, the following three are raised as the main cause though the change in the load that acts on the tank can become the cause of the spill accident.

- hydraulic pressure (static hydraulic pressure, hydraulic pressure change, and dynamic hydraulic pressure by sloshing)(preceding clause case (3))
- earthquake (preceding clause case (2))
- uneven settlement and local subsidence of base (preceding clause case (1) and (3))

The followings are thought to influence the deterioration factor of the tank bottom.

- contents, liquid temperature, properties of sludge, and deterioration in inside coating, etc.
- entering of water into the back side of bottom plate and material of base, groundwater levels, and distance from rivers etc.
- hydraulic pressure and its change and incipient defect in weld etc.



図 2.6.1 タンク底部に係る経年劣化要因

2.6.3 Occurrence process of accident

The process from the aged deterioration of the bottom of the tank to the spill accident was summarized in Figure 2.6.2. The number of cases in parentheses in the figure was a number of accidents extracted from Table 2.3.1 and Table 2.3.2 of Chapter 2 that related to 1,000 kl or more in tank capacity and corresponded to each item. The deterioration part where strength decreased with the passing age due to corrosion or a weld defect (or these combined) occurred in the tank. The tank returns to the healthy condition again if the deterioration part in prior is found by the major inspection and is repaired. But when further deterioration was progressing ahead from the major inspection or the deterioration part was overlooked by the major inspection, the deterioration part arrives at the spill accident by such cause as a hydraulic pressure (change), an uneven settlement, a local subsidence, and the earthquake. 34 spill accidents from such a bottom have occurred about the one of 1,000 kiloliters or more in capacity since 1974. The one that was broken by the combined factor with thinning by the corrosion and defect in the weld was included in that, though all causes of breaking of the weld was classified here as fatigue. In this figure, there were 13 accidents in which the spill of 10 kl or more that corresponded to 50 drum and assumed to be a large-scale spill. There is the one that seems to report on the amount of oil that was able to be collected as an amount of spill according to the office, and is the one that it is not possible to confirm it about the accuracy of the amount of spill.

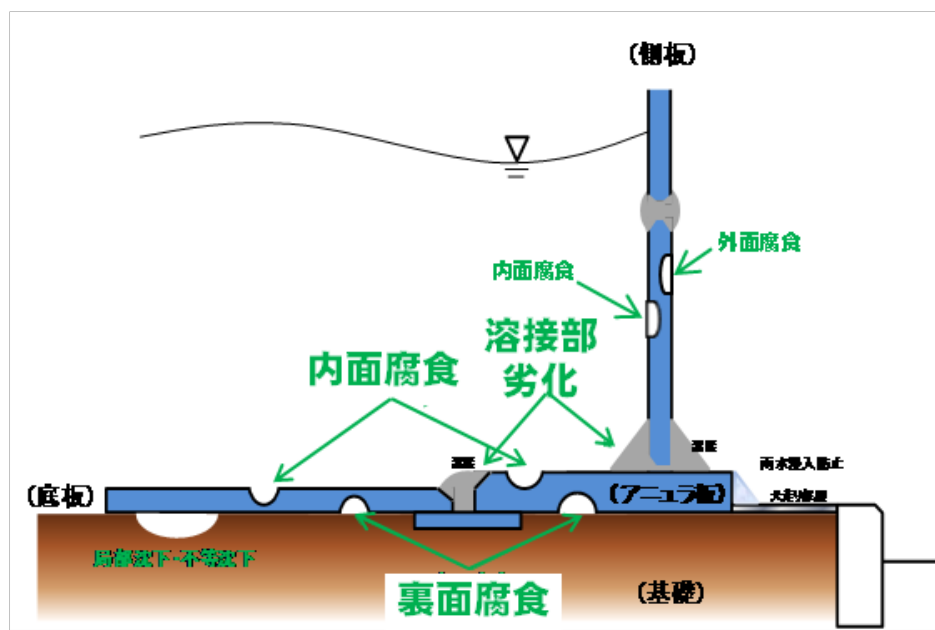

図 2.6.2 底部流出事故の事故発生フロー

2.6.4 Damage expansion scenario of spill accident

After spill accident happens, the amount of spill stays small if the stockpiles are few or the perception and countermeasure can be completed at time early compared with the oil slick speed. On the other hand, a large-scale spill occurs when the perception and countermeasure are delayed or a large-scale bottom breaking is caused by the transformation and the destruction, etc. of the base due to the outflow pressure and earthquakes. The hazardous material spill to the outside is expected to be prevented with the oil retaining dike* as for the final fort of the spill expansion prevention. But as reported on the accident case, there is the possibility that oil gets over the oil retaining dike according to the power of the effluent and the fears that the oil retaining dike is scoured ((1), (2) of 2.6.1, 2.7.3(1) a, and (2) a, b), the subterranean stream is contaminated ((4) of 2.6.1 and (1) of 2.7.3) and fires in the dike. Therefore, it is safety-critical to prevent from flowing out outside the tank itself.

*The standard of the oil retaining dike was strengthened about the structure etc. reflecting the damage of the accident in Kurashiki City, Okayama Prefecture in 1974 and the accident by the Miyagi-ken-oki Earthquake in 1978.

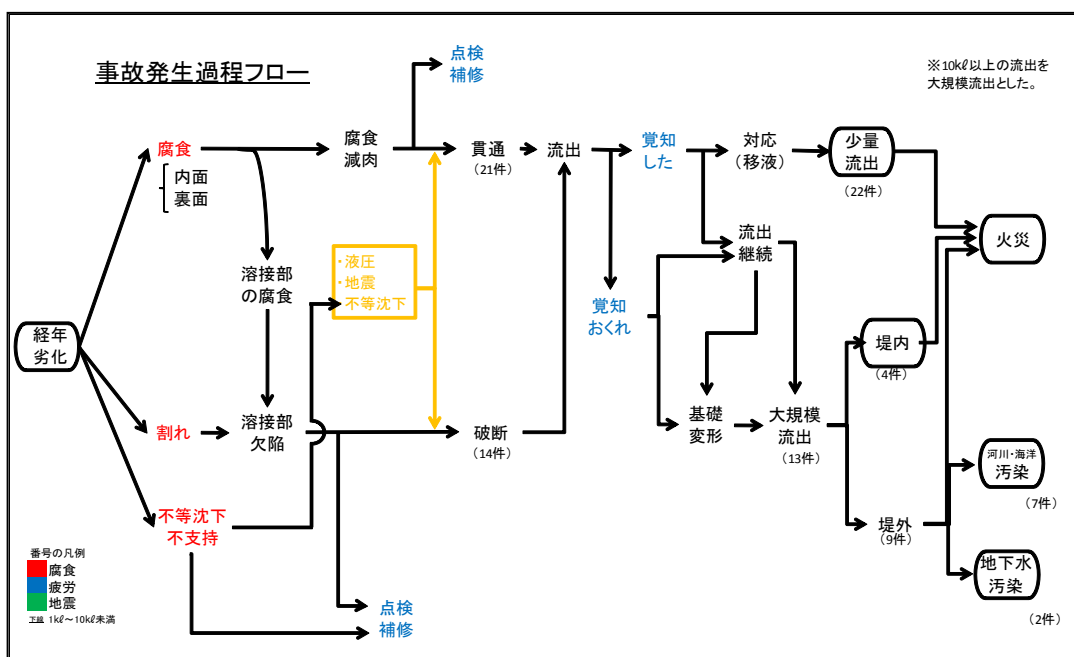
(1) The fire case due to spill accident

A fire might occur when dangerous articles flow out outside the tank. In the disaster prevention assessment of the oil industrial complex, 10^{-1} is often used as an ignition probability⁷⁾ in case of oil spill and it is necessary to recognize a fire as a disaster scenario that can be assumed. There are the following examples as a fire case that relates to the spill accident from the tank.

- a. The polybutene (the fourth kind third oil) flowed out from the corrosion hole of shell and a fire occurred in Kawasaki City in 1980.
- b. Crude oil flowed out from the piping of the outdoor storage tank facilities and fire occurred in Tomakomai City (Tokachi-oki Earthquake) in 2003.
- c. The non-lead gasoline overflowed with the trouble of level meter and a fire occurred in Hertford Shah, Britain in 2005.

(2) Environmental pollution

In the accident of Kurashiki City, Okayama Prefecture in 1974 that had become the opportunity of the safety inspection system, large-scale seawater pollution occurred. The heavy oil that flowed out polluted about 1/3 of the Inland Sea, and the removal work lasted about four months. The amount of money as a total damage cost could be

converted with about 50 billion yen in which the fishery damage was estimated as about 21.4 billion yen (Quality of the Environment in Japan in 1974). In running aground and the oil spill accident (amount of spill 6240 kl) of the Nakhodka (name of ship) in 1997 that is similar seawater pollution with a heavy oil, the oil processing cost and the amount claimed of compensation for fishermen etc. are that mounts up to 358 billion 814 million yen. In addition to the seawater pollution, if the soil and underground water are polluted, those purification is needed.

2.6.5 Situation on management of factor of accident

(1) Outline

The standard and the management method relevant to the deterioration factor that related to the spill accident from the tank in a specific outdoor storage tank facilities were summarized in Table 2.6.1. It is classified into a regular service (Once a year on the standard scale) from the outside under operation and a regular internal inspection (8 years, 10 years and 13 years cycle in case of the tank of 10,000 kl or more in capacity) as a management method.

Deterioration in the part covered by net in the table where health is confirmed in case of internal inspection will progress when the cycle of the safety internal inspection is extended. Moreover, the chance of the check and the repair from the inside comes to decrease about other factors managed by the check both under operation and during internal inspection.

(2) Object part of safety inspection

The tank bottom spill accident causes the fear that whole quantity flows out, high hydraulic pressure flow velocity generates foundation deformation and the scour of dike and the perception delay continues spill etc. And since having the possibility of a large amount of spill, it is risky. Therefore the factor of the spill accident from the tank bottom is managed by the safety inspection. A concrete management items are as follows.

- a. thickness of bottom plate (back side corrosion and inside corrosion)
- b. defect in the weld of bottom plate
- c. items concerning the uneven settlement of the base

In the above, item c is managed as below.

The amount of the subsidence in the outer part of the tank is regularly measured, and when the amount of the uneven settlement becomes 1/100 or more of the tank diameters, it has to undergo the temporary safety inspection.

(3) Part that is not object of safety inspection

It is not provided to mortgage soundness by a public inspection about a shell, a roof, and attached equipment, and the operation and maintenance of them has been entrusted to the owner etc. of the outdoor storage tank facilities. In these, there is a part where management under operation is difficult, namely internal, attached equipment etc. such as the shell (for inside corrosion check), and the roof drains, too. The chance of these management is mortgaged for such a part by the internal inspection (repair) for the safety inspection examination each eight years, ten years, and 13 every about the tank of 10,000 kiloliters or more in capacity. The spill accident from the shell stands out in recent years as understood from Table 2.3.1 of Chapter 2, and it is feared of the management situation of these parts which are off the subject for the examination.

表 2.6.1 タンクにおける劣化要因と管理の方法

	劣化要因	技術基準など	運転中の管理 (定期点検)	開放時の管理	備考
底部	裏面腐食	最小厚さ規定 裏面防食措置 (雨水進入防止措置)	(目視点検)	板厚測定	※最小厚さの測定には 腐れしる3mmを含む。
	内面腐食	最小厚さ規定 (コーティング)	—	目視、腐食深さ測定 (コーティング目視調査)	
	溶接部疲労・欠陥進展	表面欠陥の基準	—	目視及び非破壊試験	
基礎	不等沈下・局部沈下	支持力	外周での沈下量測定	—	
側板	外面腐食	最小厚さ規定 地震等による必要厚さ 規定 (塗装)	目視点検 外部からの板厚測定 (保温材があると点検不 能。)	(板厚規定) (塗装目視調査)	
	内面腐食	最小厚さ規定 地震等による必要厚さ 規定 (コーティング)	(外部からの板厚測定)	内部目視・腐食深さ測定 (コーティング目視調査)	
	溶接部欠陥進展	内在欠陥の基準	目視点検	(目視点検)	
屋根	腐食	最小厚さ規定 (塗装) 気密性	目視点検 外部からの板厚測定 目視点検	(板厚規定) 内部目視点検	
附属設備	腐食	—	目視点検 作動試験	内部目視点検 (板厚規定)	

(4) Method of management to inside corrosion of bottom

- a. The owner etc. execute the visual inspection to whole area of the bottom, and understand the deterioration situation of the coating and the generation part of inside corrosion.
- b. The corrosion depth is measured at the corrosion part with a gauge etc. by hand power. Moreover, the back side corrosion situation surrounding the part of corrosion

concerned is confirmed, and it is confirmed whether the plate thickness of the inside corrosion part meets the requirement of standard in the law.

c. Repair when it doesn't meet the requirement of standard in law. Moreover, even when it meets the standard in the law, the inside corrosion part concerned might be repaired with an independent repair standard of the owner etc.

d. When safety is inspected, the mayor of municipality etc. confirms whether the visual inspection is executed and minimum plate thickness of the corrosion part meets the requirement of standard in the law.

(5) Method of management to the back side corrosion of bottom

a. The owner etc. measure plate thickness from the tank interior with the supersonic wave thickness gage.

b. A general measurement part is that shown in fire fighting [abuna] the 56th notification "Enforcements of the government ordinance concerning the restriction of dangerous articles and the government ordinance, etc. in which a part of the fire fighting method enforcement order is revised" (Hereafter, it is said, "The 56th notification") etc. on March 30, 1977 (refer to Figure 1.2.1).

c. When plate thickness doesn't meet the requirement of standard in the law, the substitution repair of the bottom plate is executed. Moreover, the bottom plate might be exchanged without the inspection if the plate to which the situation of the occurrence of the corrosion was checked at the last internal inspection and planned to substitute before it opens it this time. (about the repair results, refer to 2.2)

d. In the safety examination, plate thickness data is extracted from the measurement part of the above-mentioned owner etc., and the mayor of municipality etc. confirm whether minimum plate thickness meets the requirement of standard in the law.

e. Because the back side corrosion could not be checked visually different from the inside corrosion as shown in above, the tendency has been managed by the plate thickness measured by the extraction point. In recent years, the technology that can continuously measure plate thickness has been established, and back side corrosion is thought to be manageable equal with inside corrosion by its use.

(6) Method of management to weld of bottom

a. Generally, the owner etc. executes the visual inspection of whole weld line.

b. The magnetic particle testing etc. is executed to the weld line shown in the 56th notification or to whole weld line according the owner, etc.

c. The repair of the weld is executed by the judgment of the owner in the safety

measures etc. (about the repair results, refer to 2.2).

d. When safety is inspected, the nondestructive testing is done to the extraction point from the part of a visual inspection and examination by the above-mentioned owner, etc., and the mayor of municipality etc. confirms whether to meet the requirement of standard in the law.

(Reference) The inspection parts of the magnetic particle testing in the weld shown by the 56th notification etc. are as follows.

a. in the weld joints inside of the tank between shell plate and the annular plate (in the one that the annular plate has not been installed, the bottom plate is said. It is the same as follows), the butt welding joints between the annular plates and the welding joints between the annular plate (limit it at 1m in width of the annular plate that projects toward the central portion of an inside tank from the shell), whole weld joints

b. among the weld joints of the bottom plate, whole three piece piling weld and treble point weld

c. in the weld joints between the annular plate (limit it to the one to project from the inside of the shell toward the center part of the tank and for the width of the annular plate to exceed 1m) and the bottom plate, whole three piece piling weld and treble point weld

d. among the weld joints of the bottom plate, if they are horizontal joints and the welding worker and the welding construction method are the same, arbitrary one place

e. the part that is jig installation mark and in which examining is admitted necessary

(7) Relation between inspection cycle and accident factor

When the inspection cycle becomes long, the progression rate is not necessarily constant though the aged deterioration of the tank progresses between the cycles (refer to 2.4 and 2.5). Moreover, the deterioration factor to change the deterioration rate like flaking off of the coating and the change of the contact situation of the base and the bottom plate greatly can be caused in the tank bottom plate. Safety in the tank has been maintained to these by a confirmation of it through a regular internal inspection and by recovering it by the repair to a necessary part (refer to Figure 2.6.3). When the inspection cycle is examined, it is necessary to pay attention to the change of the influence owing to the uncertainty of the deterioration progress degree if the intervals of the repair chance change



図 2.6.3 タンクの経過年と補修による板厚の関係のイメージ図

Moreover, when the tank is opened for safety inspection the check and repair of the deterioration situation of the shell, the roof and attached equipment is done besides the confirmation of soundness in the plate thickness of the bottom and the weld which are the inspection object opened, and these are assumed to be a matter that should be considered in thinking about remaining life of the tank⁹⁾. When the cycle is examined about the safety inspection, the method of mortgaging safety of such a matter should be considered.

(8) Stress that acts on bottom of tank and structural criteria that lie tanks in specific outdoor storage tank facilities

a. stress that acts on bottom plate

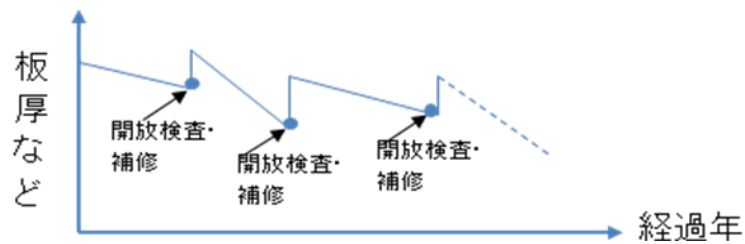
- ・residual stress by welding and stress that originates in coming to the surface of bottom plate from base

- ・uneven settlement and local subsidence of base, and stress by uneven settlement and local subsidence due to earthquake

b. structural criteria to bottom plate

- ・Minimum thickness of the bottom plate in the new law tank of 10,000 kl or more in capacity is 12mm (No.17 2 of the ministerial ordinance of Article 20 of the 2nd and 4 Articles 4 in clause 2 of notification). This thickness includes 3mm corrosion allowance¹⁰⁾.

c. stress that acts on annular plate

- ・residual stress by welding and stress that originates in coming to the surface of bottom plate from base

- ・uneven settlement and local subsidence of base, and stress by uneven settlement and local subsidence due to earthquake

- ・bend stress by shell load and hydraulic pressure (static hydraulic pressure and dynamic hydraulic pressure)

- ・bend stress by coming to the surface of bottom at earthquake

d. structural criteria to annular plate

- Minimum thickness and the size of the annular plate of the new law tank are decided according to the thickness of the lowest plate of shell (refer to Table 2.6.2). The thicknesses shown include corrosion allowance of 3mm¹⁰).
- Moreover, the idea of the second design is taken, and the annular plate of the range of 500mm from shell is provided for to become plate thickness where the plastic strain stays within the constant range for the assumed seismic ground motion for the behavior of the tank coming to the surface at the earthquake (four two Articles 79 1 in clause 2 of notification of the ministerial ordinance of Article 20).
- The welding method is the butt weld by the use of the back application material for the new law tank of 10,000 kl or more in capacity (Or, method with strength more than the equal to this) (No.3 in four clauses 3 of the ministerial ordinance of Article 20).
- As for the base, the bearing capacity, the distance from underground water and the reinforcement measures that are necessary to become a structure not transformed easily are provided (paragraph the 4th and 5 and six titles of the ministerial ordinance of Article 20 of two clauses 2).

表 2.6.2 アニュラ板の最小厚さに係る基準

側板の最下段の厚さ (単位 mm)	アニュラ板の各寸法等 (単位 mm)		
	側板外面からの張出し寸法	側板内面からタンク中心部に向かつての張出しの長さ	最小厚さ
15 を超え 20 以下のもの	75	1,000	12
20 を超え 25 以下のもの	100	1,500	15
25 を超え 30 以下のもの	100	1,500	18
30 を超えるもの	100	1,500	21

2.6.6 Factor analysis from accident case

With respect to the spill accident from the bottom of the tank of 1,000 kl or more in capacity extracted from Table 2.3.1 and Table 2.3.2, the accident factor and the size of the opening were brought together from the accident case collection and the accident cause investigation report (refer to Table 2.6.3 and Table 2.6.4). It stays in four (foundation construction, wear-out, and 2 over grinder) (about 14%) about the accident in which the initial malfunction takes part among 29 accidents of the bottom under normal operation, and it can be said that the aged deterioration is a main accident factor usually. Though it was assumed that there was the one that defective construction of the coating, the defect of inside in the weld and on the back side of the bottom plate took part, these were not able to find out by a present technology. So, it is reasonable to consider that the defect was expanded according to the aged deterioration afterwards and



内面腐食貫通孔の例（事故事例 90）



図 2.6.3 危険物施設からの腐食による流出事故の、開口部の寸法と流出量の関係¹¹⁾

caused the spill accident, and it is arranged that the aged deterioration was the main accident factor. Though data was little, the size in the opening was reported by five of 17 accidents due to inside corrosion, and the size was assumed to be from several mm to tens of mm in diameters (there was a case where two or more penetration were found, too). The opening size was reported by two of four accidents of the back side corrosion, and it was 3mm and 50×60mm in diameter respectively. It is understood that the spill accident occurs because of the penetration hole of about from several mm to tens of mm by local corrosion. Figure 2.6.3 shows the relation between the size (the diameter of the corroded pore: ordinate) in the opening and the amount of flow (the amount of the leakage: horizontal axis) of the spill accident due to corrosion from a domestic hazardous materials facility¹¹⁾. Though the spill can be said not to stay in a small amount when the size in the opening is large, it is understood that there is a big difference in the amount of spill when it is small. It can be said for the amount of spill

that the influence by the stockpile, pressure and time from the spill to the correspondence completion are larger than that of the size in the opening. When the spill accident occurs from the bottom of a big tank of capacity, a large-scale breaking might be caused by the transformation and scour of the base according to forming weakening of the base by a high hydraulic pressure and the exit velocity and temporary water channel ducts. Such cases occurred in Kurashiki City in 1974¹⁾, Sendai City in 1978²⁾, Belgium in 2005¹²⁾, France in 2007¹³⁾. Figure 2.6.4 is the one of the accident case with France occurred in December, 2007, and the accident that is at first a small-scale spill expands rapidly by destroying the base. In the spill accident from a large-scale tank, it is understood that the danger of expanding rapidly is high though the spill is small-scale at first. Moreover, the example of the accident in our country where a part of the base was destroyed is shown in Figure 2.6.5 though it did not caused a large-scale flow out fortunately.

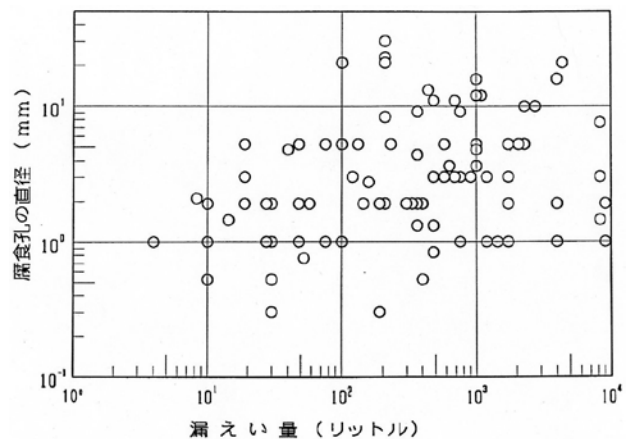

当初は少量流出であった
(1月11日15時)



基礎が変形洗掘された
(1月12日8時)

この間に急激な流出があり、防油堤を超えて外部へ流出。住民の避難や道路や鉄道の封鎖、河川の汚濁を引き起こした。



基礎が洗掘された結果、底部の下に隙間を生じ、アニュラ板が破断している状況

図 2.6.4 底部流出事故が基礎損壊により大規模な流出事故へ拡大した事例 (フランス)¹³⁾

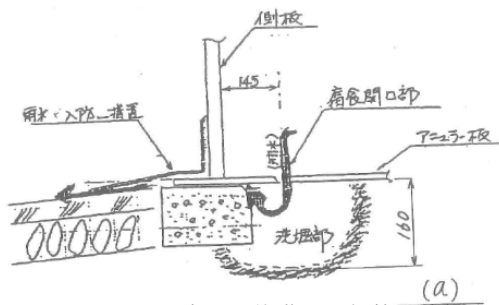

Φ 7mm の穴からの流出で基礎が局部的に洗掘された事例



図 2.6.5 国内での基礎の損壊事例 (大規模流出に至らなかったもの)

2.6.7 Influence case when hazardous materials flow out

(1) Damage event assumed due to spill accidents of hazardous materials

It is arranged in Figure 2.6.6 about what damage event is able to occur when spill accidents of hazardous materials happens. When hazardous materials flow out from the oil plant etc. on a large scale, an indirect influences like those to an entrepreneur around the fisherman, a related entrepreneur, the resident, and the ecosystem effect are caused besides the direct loss such as the value of hazardous materials, the repairing cost of the damaged facilities and the opportunity losses by the facilities stops etc.. When a large scale accident occurs, an indirect damage cost might become several time order large compared with a direct damage cost. The presumption of the amount is very difficult though indirect damage might be covered by insurance.



図 2.6.6 危険物の流出事故が発生した場合に想定される被害事象

In the damage event, the economic loss etc. can be easily converted to the amount of money. On the other hand, another is difficult to convert to the amount of money. In the latter, it is considered such as influences that for the ecosystem, obstacle on the life environmental preservation with the gas smell and oil slick¹⁴⁾ and the anxiety of the resident in the surroundings that it is likely to become a fire. Especially, it is thought that a large-scale hazardous materials facilities are often adjacent to the residential quarter in Japan, and the influence into which these amounts of money cannot be

converted occurs easily. Therefore, it is important to decrease the spill accidents of as much as possible of if it sees from the standpoint of the resident in the surroundings. From the above-mentioned viewpoint, the outline of the accident, the damage situation, compensation, and other influences were investigated about a past hazardous materials spill accident case.

(2) Exxon Valdez title oil spills accident ^{15) 16)}

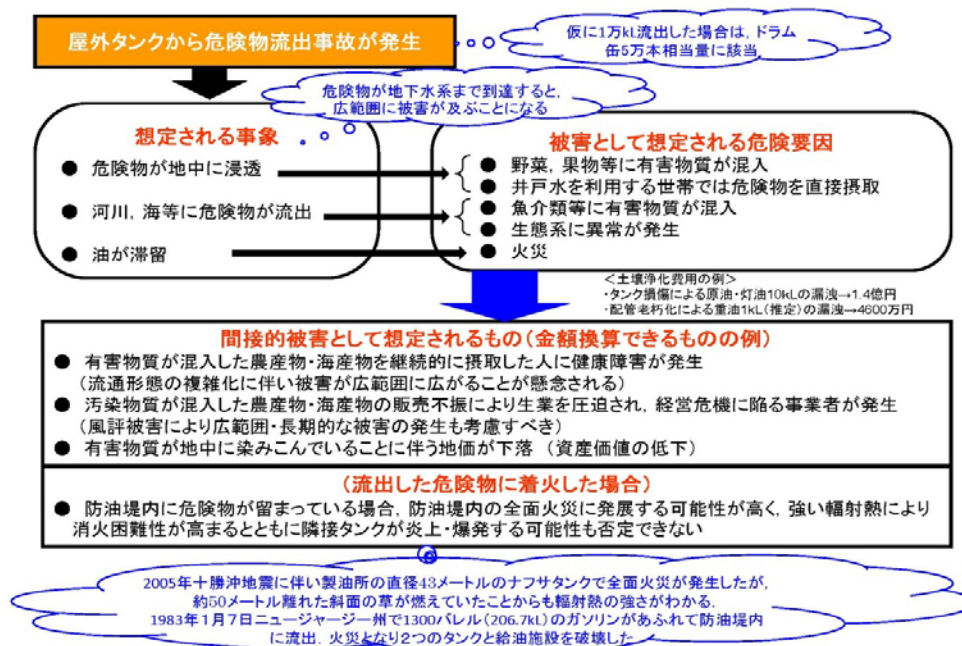
a. Outline of accident

- date of occurrence: Before dawn March 24, 1989
- crash site: offing Prince William bay in Alaska state, United States
- outline of the accident: Tanker carrying oil "Exxon Valdez title" that an Exxon mobile company owned piled up the crude oil of 53 million gallons (200,000 kl), left the Valdez oil terminal in Alaska state, and faced California state at 9:00PM, March 23rd, 1989.



米国海洋大気圏局HPより

However, it ran aground in Alaska state offing Prince William bay at 0:00AM of the 24th the next day, and the crude oil of 11 million gallons (42,000 kl) that were about 20% of the load flowed out.

b. Damage situation

- The crude oil 11 million gallons (42,000 kl) flow out. Spilled oil extended to the Prince William bay on earth, and reached over 350 miles (560km).
- Fishes like herrings and the salmon, the sea bird and the sea animal etc. were much damaged. Especially the herrings fishing suffered the devastating damage and the amount of it exceeded 280 million dollars (about 25 billion yen).
- 250,000 seabirds, 2800 sea otters, and 250 bald eagle died because of the accident. Environmental pollution became a big problem.

c. Compensation

- Compensation of Exxon mobile company
Decontamination cost about 2.1 billion dollars (about 190 billion yen)
Compensation of 300 million dollars or more to local people including fisherman (about 27 billion yen)

• punished compensation for damages to Exxon mobile company

Anchorage district court decision in 1994: five billion dollar. → appeal

decision of federal appeal trial in 2006: 2.5 billion dollars→ appeal

Federal supreme court in 2008: 507 million dollars (about 46 billion yen)

- The Exxon mobile company load total is 4.3 billion dollars (about 390 billion yen).

(3) Nakhodka title oil spill accident ¹⁷⁾

a. Outline of accident

- date of occurrence: before dawn January 2, 1997
- Crash site: Oki island offing, Shimane Prefecture, The Sea of Japan
- outline of the accident: the ship tanker Nakhodka title of the Russian nationality piled up C crude petroleum 19,000 kl, and while sailing from Shanghai for Petropavlovsk under the situation of about 20m in velocity of the wind and the wave about high 6m, the prow part broke and the stern part sank at north-northeast about 106km of Oki island offing in the Shimane Prefecture before dawn January 2, 1997. The prow part was washed to the bedrock in the vicinity of Ando cape of Mikuni town, Sakai-gun in the Fukui Prefecture while being thrown into the current and the wind on the afternoon of January 7th. C heavy oil 6,240 kl that had been loaded flowed out due to this accident.



国土交通省HPより

b. Damage situation

- C heavy oil 6,240 kl flowed out. The oil that flowed out was thrown into the tide, and extensive pollution damage occurred in the coast put from Shimane Prefecture on Akita Prefecture.
- big damage was given to the local municipality, the fisherman, and the travel industry person, etc. Sales of the local travel industry and the fishery (crab etc.) in the region without seawater pollution by oil spill was decreased by rumor damaged¹⁸⁾, too.
- five people die by overwork etc. though a lot of local people and volunteers participated in the oil collection work and the cleaning work.
- a lot of birds (the threatened species was included) that suffered damage by the oil contamination were washed to shore coast of the Sea of Japan from Aomori Prefecture to Yamaguchi Prefecture. Among these, the number of individuals in which the protection accommodation was done was 1,315 and 11 families and 37 kinds were recorded as a kind. A lot of one that was rhinoceros auklet was 497, and next was 455 of the razorbill in the record. When the one not accommodated and what had sunk at the bottom of the sea before it got to the coast were put together, actual damage was presumed to be a number of individuals 2 to 3 time in the razorbill and 6 to 7 times in the rhinoceros auklet of the number of protection accommodation.

c. compensation

- compensation is 26 billion 127 million yen to which reconciliation was approved in August, 2002.

国及び海上災害防止センターへの補償額

請求者	請求内容	請求額	補償額
国	油防除・回収・清掃費用	15億19百万円	18億87百万円(注1)
海上災害防止センター	油防除・回収・清掃費用	154億21百万円	124億50百万円(注2)

(注1) 債権権利法上必要とされる遅延損害金を含む。(注2) 仮設道路に係る補償額20億48百万円を含む。

その他の被害者への補償額

請求者	請求内容	請求額	補償額
漁業者	漁業被害(清掃費用は除く)	50億13百万円	17億69百万円
観光業者	観光被害(水族館含む)	28億41百万円	13億44百万円
地方自治体	油防除・回収・清掃費用	71億43百万円	56億38百万円
船主	不明	11億29百万円	7億74百万円
その他	不明	27億48百万円	22億65百万円

(国際油濁補償基金資料による)

(4)United States oil mining base explosion & blazing up and oil spill accident ²⁰⁾

a. Outline of accident

- ・date of occurrence: Night, April 20, 2010
- ・crash site: the Gulf of Mexico, offing (Venice southeast about 84km) in Louisiana state, southern part of U.S.
- ・outline of the accident: at the digging base "Deep water Horizon" of the Gulf of Mexico operated by BP, there was suddenly a big explosion, and the base had blazed up. It was reported that within 126 workers, 11 people were assumed for missing and 17 people to have been injured (in those three were seriously injured) due to the accident. Three places of the pipeline that connected the bottom of the sea of about 1,500 meters in depth with the base by this explosion were damaged, a large amount of crude oil flowed out, and the part on the sea in the digging base went under water on April 22. The outflow of crude oil to the ocean continued until the lid was done on July 15. It was at September 19 that countermeasure ended completely by digging up another oil well.

b. Damage situation

- ・The amount of the total spill evaluation announced on August 2 is the one about 4.9 million barrels (780,000 kl)(the error margin is $\pm 10\%$), of which about 4.1 million

barrels (650,000 kl) flowed out to the ocean.

- The U.S. government restricted the fishery with about 200,000km² (about ten times that of the Inland Sea). Large-scale pollution damage had extended.

c. Compensation

- The cost paid by BP reached about 1.6 billion dollars (about 146 billion yen) by June 14. 175 million dollars in total (about 15.9 billion yen) were offered to four states (Louisiana, Mississippi, Alabama, and Florida) where the emergency declaration was done.

- BP concluded the tentative agreement of 20 billion dollars (about 1.8 trillion yen) with a U.S. President as local populace amends etc. on June 16.

- The main body of BP and the amends organization have paid the total of the compensation including under the procedure is 2,350,689,296 dollars (about 200 billion yen) according to the announcement of BP on September 30.

(5) Mizushima oil spill accident ²¹⁾

a. Outline of accident

- date of occurrence: December 18, 1974

- crash site: refinery that faced the Inland Sea in Kurashiki City, Okayama Prefecture

- outline of the accident: the crack occurred in the fillet weld between the lowest shell plate and the annular plate of the dome roof tank of 50,000 kl, and the heavy oil leaked. It failed in the transportation of the heavy oil and the heavy oil that flowed out had diffused to the Inland Sea through the drainage trench because the oil retaining dike was destroyed by the fall of the vertical stairs in the tank. The heavy oil that flowed out outside the tank reached about as much as 43,000 kl.

b. Damage situation

- 7,500-9,500 kl of heavy oil of about 43,000 kl flowed out to the sea. 1/3 of the Inland Sea had been polluted.

- The heavy oil that flowed out reached Sakaide city, Takamatsu City in Kagawa Prefecture and the Naruto strait because of the strong wind and the ebb, etc. , and gave the devastating damage to the fishery of the cultivation of the sea weed and the young yellow tail etc.

- The people involved in the salvage operation of the heavy oil spilled that reached the extension 470km were

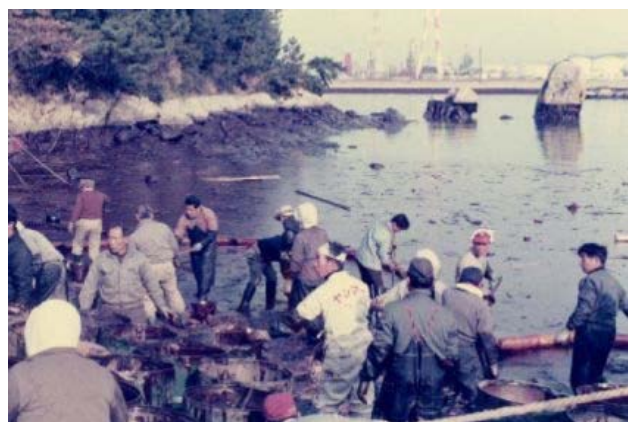

坂出市HPより

357,000 people in total. It was at April 15 next year that the cleaning work in the Inland Sea coastline ended.

(6) Vance field oil terminal fire ²²⁾, Britain

a. Outline of accident

- date of occurrence: December 11, 2005
- crash site: Vance oil terminal field, Hemel Hempstead, Britain
- outline of the accident: The overflow was occurred by the trouble of the level meter while receiving the non-leaded gasoline to the tank in the oil terminal (400 kl or more presumed). Steam was ignited, and it had blazed up to the explosion and 23 tanks were blazed up. 43 injured persons. Even the extinction of fires required five days.

b. Damage situation

- The oil terminal and the factory in the surroundings were destroyed due to the blast and a fire. About 60,000 kl of the fuels of about 100,000 kl stored at the oil terminal disappeared and even five days were required by the extinction of fires.
- Smoke from the fuel that burned brightly exceeded a southern part of British and it had extended widely. PFOS (A kind of organofluoric compounds and object of abolishment and limitation because of its toxicity) included in extinguishing media used had contaminated the subterranean stream.
- Since the oil terminal supplied about 50% of aviation fuel to Heathrow Airport as a pipeline base, obstacle was caused in refueling to aircraft over a long term.
- As the long-haul route for Australia, the Far East, and the South Africa, it was done for another airport to pass for fueling through necessity.

c. Compensation

- An economic loss due to the accident is provisionally calculated as follows.

< economic loss breakdown of each influenced sector >

airlines industry; 245 million pounds (about 33 billion yen)

compensation; 625 million pounds (about 84 billion yen) (about intervention of jurisdiction agency and government; 15 million pounds (about two billion yen)

environmental damage of tap water; two million pounds (about 300 million yen)

for emergency; Seven million pounds (900 million yen)

in total ; 894 million pounds (about 120 billion yen)

< breakdown of above-mentioned "Compensation claim" >

five people of enterprise in site; 103 million pounds (about 14 billion yen)

749 people of enterprise outside site; 488 million pounds (about 66 billion yen)

3,379 individual; 30 million pounds (about four billion yen)

seven people of local government office; four million pounds (about 500 million yen) in total; 625 million pounds (about 84 billion yen)

• 16 companies moved, and 1,422 employees were transferred, too. 1,200 people lost the employment by moving or going bankrupt of the enterprise.



(7) Spill accident from tank at Floreffe in Pennsylvania state²³⁾

a. Outline of accident

• date of occurrence: January 2, 1998

• crash site: Floreffe Ashland Oil company of Allegheny County in Pennsylvania state, United States

• outline of the accident: The shell of the above ground tank of 15100 kl (four million gallons) tore at a dash, kerosene flowed out rapidly, the oil retaining dike was destroyed, and 3,785 kl flowed out outside of site. Part of it flowed into the Monongahela river and had polluted the aquatic environment widely.

b. Damage situation

• It became impossible to do the getting water of the drinking water of about one million residents around Pittsburgh and the drinking water supply was hindered.

• 1,200 families took shelter, and tens of factory and two or more school were closed.

• The ecosystem was destroyed and the wild bird and the fish that were killed reached several thousand. The number of waterfowls that died such as the duck, the red-throated diver, cormorant and the Canada goose, etc. is calculated with 2,000 to 4,000²⁴⁾.

(8) Diamond Grace title accident²⁵⁾

a. Outline of accident

• date of occurrence: July 2, 1997

• crash site: Nakano-rapids in Tokyo Bay.

• outline of the accident: Tanker "Diamond Grace title" ran aground in Tokyo Bay in Nakano-rapids, and the crude oil 1,550 kl flowed out to the sea. The odor trouble was caused widely according to the volatilizing crude oil element because it was light quality

crude oil. The anxiety concerning safety was caused in the resident as the inquiry about "Fear of the ignition" was at the fire fighting headquarters from the resident.

·「It was guessed that the low boiling point hydrocarbon that ignited easily volatilized and had diffused into the air in about 6 or 7 hours after the accident. Because the water temperature was high in summer, and the wind had blown, volatilizing might have been fast. If it had misjudged around here, the fire of the engine ignited to the oil slick, and there was a possibility of becoming sea of flames in one side, too.,」²⁶⁾

b. Damage situation

·Mainly from Chiba Prefecture that lies to the leeward side, and from far a way within the range to reach Mito City, Ibaraki Prefecture, there were inquiries and complaints (the complaint number: 3,200 or more in Chiba Prefecture, 458 in Tokyo and about 100 in Ibaraki Prefecture) concerning the stink ²⁷⁾.

·It was reported to be 21 people ambulance transportation due to the stink (18 in Tokyo, 3 in Chiba; one of them was hospitalized for the passage observation) and to be 21 people who consulted a physician of the medical institution in Chiba prefecture.

·The amount of damage due to this accident was presumed about three billion yen by Japan Association for Preventing Marine Accidents.

(reference)

It is provisionally calculated that the amount of the presumption damage when the crude oil 23,000 kl flow out in Tokyo Bay is about 28.7 billion yen (Depend on Japan Association for Preventing Marine Accidents).

References cited

- 1)Mitsubish Oil Co Ltd Mizushima Oil Refinery tank accident cause investigation committee: December 18, Mitsubish Oil Co Ltd Mizushima Oil Refinery tank accident cause investigation report book and 1975
- 2)Technological Fire and Disaster Management Agency dangerous article standard committee: September 20, Miyagi-ken-oki Earthquake northeast oil Sendai oil manufacture place oil tank damage cause investigation report book in 1978 and 1979
- 3)[Asamichi] Kamei: Damage, the measures, welding journal, the 5th volume 52 issue, and 1983 of oil storage
- 4)K oil factory of T Ltd.: September, No.19 tank oil leakage accident cause investigation report book and 2006
- 5)Office M Ltd. O: September, report and 2003 to styrene tank leakage

- 6)K industrial stock association company C oil factory: August, accident investigation report and 2010 concerning tank bottom board leakage accident
- 7)The Fire and Disaster Management Agency special disaster room: Disaster prevention assessment indicator and 2001 of oil industrial complex
- 8)Masumi Yazaki and [shintarou] Goto: About the assessment standard of the amends claim of the local public entity, in the Nakhodka title oil spill accident, the global environment research, Vol. 8, and 2006.
- 9)The Fire and Disaster Management Agency: February, investigation examination report and 2008 concerning [yojumyou] presumption of outdoor tank reservoir
- 10)Oil industrial complex zone disaster prevention measures Technical Assistance Committee: Technological standard (idea) December, report and 1976 concerning tank and base
- 11)A. Kamei (1987): "Leakage Accidents due to Corrosion in Plant Handling Hazardous Materials", Corrosion Engineering, Vol. 36, pp. 603-609.
- 12)Employment, Labour and Social Dialogue, Federal Public Service: "Safety Alert : Rupture of an (atmospheric) crude oil storage tank", Document No. : CRC/ONG/013-E, November, 2006.
- 13)Arnaud Gu?na, Emmanuelle Poupon, Mika?L Laurent:"AMBES OIL DEPOT -Crude oil tank failure 12/01/2007-" and Freshwater Spill Symposia 2009. 14) Technical committee like Central Environmental Council soil agricultural chemicals departmental meeting soil pollution technology standard etc. : Oil pollution measures guideline?Idea of action on [aburanio] and oil slick problem of originating in soil including [hekoabura] by landowner etc. 、 March..Alaska..state..March..reference..oil pollution..pollution..damage..compensation..compensation problem..Nakhodka..title..accident..case..harmful rumor..economic loss..research..safety engineering..No...old..south..oil contamination..seabird..damage..afterwards..sea..safe..No...spring..title.
- 23)Pennsylvania state HP
- 24)Times.com HP
- 25)The Fire and Disaster Management Agency damage report
- 26)Morality rice field [hirogashi]: Issue in summer of sea, safety, and No.463,1997 thought to be D and Grace title accident
- 27)The Naomi Yoshida and others: About the result of a measurement of the air sample, in the diamond Grace title oil outflow accident, the Chiba Prefecture Institute for Environmental Studies research report, No.30, and 1998.

2.7 Comparison with overseas outdoor tank reservoir

2.7.1 Comparison concerning environment

(1) Natural environment

As for the back side corrosion of the deterioration factors of the tank, it is different that the progress speed depending on the climate factors of the soil temperature and the rainfall, etc. Our country's possibility that the back side corrosion is promoted compared with America and European countries is high because it is clement and there a lot of precipitation. Moreover, the incidence of the earthquake that becomes the factor of the transformation of the base is also high, and the climate factor of the damage of the tank is at unfavorable terms compared with that of Europe and America. The difference of the environment of Europe and America and Japan was summarized in Table 2.7.1.

表 2.7.1 タンクを破損する環境要因の比較 ^{1)、2)、3)、4)}

	年平均降水量 (mm)	年平均気温 (°C)	過去 10 年間のM7以上の地震の発生件数
日本	1690	東京 16.6	14
米国	国 715 ニューヨーク州 ニューヨーク市 1200 ミネソタ州 ミネアポリス 719 アラスカ州 ジュノー 1379 カリフォルニア州 ロサンゼルス 305	7.4 5.1 4.8 15.2	4
欧州	イギリス 1220 フランス 867 ドイツ 700	ロンドン 10.0 パリ 10.9 ベルリン 9.7	2 (トルコ)

2) Social setting

Environmental pollution in addition to the fear's of a fire rising when the spill accident happens from the tank on a large scale occurs. It is thought that the influence level of the damage is decided by the location of the tank such as the distance with the residential quarter, the height of underground water and the distance to the river coast etc. and the use state of the near-shore waters etc. Moreover, it is likely to relate to the risk tolerance of the society. For instance, there had occurred 124 fires of the tank every

13 years from 1990 to 2002 in USA ⁵⁾ (reference: Our country is 2). Moreover, it is assumed that the pollution of underground water has been found by 85% of facilities where underground water was analyzed in the tank facilities with the storing capacity of 380 kl or more (one million gallons) in Virginia intrastate ⁶⁾.

2.7.2 Situation of regulation of foreign countries

(1) USA

The United States federal government is not provided for about the inspection cycle of the structural health though provides for regulation of the tank in 40CFR112 (the tank that lies a pipeline is 49CFR195). It seems that the state government is chiefly regulating the tank from the viewpoint of the environmental pollution prevention. It divides into states with regulations and states without regulations about the cycle of the shut down inspection of the tank etc..

The cycle of the internal inspection is provided ten years in three states (New York state, Virginia state, and South Dakota state).

a. Virginia state, USA

The aboveground tank of about 45 kl or more (12,000 gallons) in capacity of the tank storage facilities of total 3,785 kl or more (one million gallons) or the above ground tank of the capacity of 3785 kl or more with the unit become objects. If validity can be shown for state authorities by owners etc., its extension is possible (9VAC25-91-130).

b. New York state, USA

The aboveground tank of 38 kl or more (10,000 gallons) is an object. Several hundred thousand tanks are in intrastate and the total capacity is assumed to be about 13.2 million kl.

Exception: the above ground tank which locates at oilwell or which has double-bottom or impermeable barrier, leakage detection system, electrolytic protection, and outside painting (6NYCRR613).

c. South Dakota state, USA

The aboveground tank (94.6-kl in capacity or less in capacity are excluded) in the storage tank facilities of 946 kl or more (250,000 gallons) in the total capacity is objects. There are no regulations on the cycle of the internal inspection according to state (for instance, California state). It is thought that the cycle has been decided for that case depending on the tank owner etc.. and it is assumed that there are a lot of owners etc. who decide the method of managing maintenance such as cycles based on the civil standard named API653 (Tank Inspection, Repair, Alternation, and Reconstruction) according to a past investigation etc.. Moreover, there is state where it is regulated to

conform to API653, too (For instance, in Alaska state).

•Alaska state, USA

The owner of the aboveground tank of 38 kl or more (10,000 gallons) in capacity, the above ground tank in facilities where the refined oil of 1,600 kl or more (420,000 gallons) is treated or the above ground tank in facilities where the crude oil 3,200 kl (210,000 gallons) are handled is assuming that he or she should do the check maintenance based on API653 (the third edition).Moreover, “when you may shorten the interval for the above ground tank where 30 years are exceeded from the installation” is being added by state authorities. Following "Similar tank" assumption is not admitted (18AAC75.065).

In API653 (the fourth edition), the tank is assumed to do the internal inspection in ten years or less after it is installed (When there is a tank similar to the object tank well and the corrosion rate of a similar tank concerned is judged applicable to the object tank by the tank engineer, it is possible to decide it separately) as a standard.

The time of the internal inspection since the second times is assumed to calculate years in which the plate thickness of the bottom (or shell) becomes constant thickness by using the corrosion rate measured at last inspection when assuming that corrosion will progress at the same speed in the future, and to use it for the next inspection (However, it is within 20 years at the maximum). Though the realities are uncertain whether how much internal inspection cycle of the tank is actually performed by this method, it is assumed that average inspection periods of 55 tanks of 300-12,490 kl in capacity in 2000 were 11.5 years according to Minnesota Pollution Control Agency⁷).

In the fourth edition of API653 (April, 2009) as a decision method of another inspection time, the next inspection time is enabled to be decided by the tank engineer considering a specification of the tank and the influence of spill based on the idea named RBI. According to this idea, first time inspection is assumed to be within 12 to 25 years depending on the tank specification, and since the second time upper bound is 25 years, moreover is shown 30 years as upper bound for the tank which has the outflow diffusion prevention barrier (special mechanism having function of spill perception and diffusion prevention set on the tank bottom and base). It is in recent years for such a long-term period to be provided, and the application results (for instance, incidence etc. of the accident) are not clear. Moreover, it is assumed that the engineer decides it by capacity, the specification, and the location, and the information about what period is being applied to the tank which has equal location, structure and capacity to those of the outdoor storage tank facilities which are the object of safety inspection of our country is insufficient. Therefore, it is difficult to discuss now whether such upper bound years can

be applicable to the outdoor storage tank facilities in our country.

(2)Europe

The interval of the internal inspection is as follows depending on the document about Europe⁸⁾.

Belgium: 20 years

France (crude oil and clean product): ten years

Germany: five years (It is possible to extend to ten years according to the level of the inspection).

The Netherlands: 12 years

Britain: There is no regulation.

Though the tank owner etc. come to decide the cycle of internal inspection when there is no regulations by the country such as Britain. In the third edition of EEMUA159, (2003), it provides as a standard cycle as shown in Table 2.7.2. It is not described in the third edition though the idea of the representative tank was shown in a previous version of EEMUA from 2003.

表 2.7.2 EEMUA159 第 3 版 (2003 年) の標準的な周期

グループ	サービス、条件	検査頻度						
		外部ルーチン目視検査 (月)	外部詳細目視検査 (側板と屋根の肉厚検査を含む) (年)			内部の詳細目視検査 (側板と屋根の肉厚検査を含む) (年)		
			気候コード*			気候コード*		
			A	B	C	A	B	C
1	スロップ油、腐食性化学物質、非処理水、海水 (コーティングなし)	3	1	1	1	3	3	3
1 A	上記サービス (コーティングあり)	3	5	5	7	7	7	7
2	低温貯槽	3	(特別に扱われている: 詳細省略)					
3	原油	3	5	5	7	8	8	10
4	燃料油、ガス油、潤滑油、ディーゼル油、苛性ソーダ、不活性・非腐食性化学物質、	3	5	8	10	12	16	20
5	Jet A-1 (コーティングあり)	3	10	10	15	15	15	20
6	軽質油、灯油、ガソリン、分解留分、処理水 (コーティングなし)	3	3	5	7	8	10	12
7	加温・保温タンク (外部 UT 検査は、側板の底部近くと屋根の周り何点かで測定)	3	3	3	5	6	6	6

*気候コード

A: 暖かく高湿。例えば熱帯、亜熱帯地域。

B: 温暖でしばしば雨と風がある地域。

C: 暖かく乾燥 例えば砂漠。

Besides this, the method of deciding the internal inspection cycle in accordance with RBI is provided for in EEMUA. It is the method to decide the next inspection time from relation to the remainder plate thickness to management standard plate thickness using corrosion rate which is based on 1 time or more internal inspection of the tank and to consider the level of occurrence of accident according to tank specification etc. and damage of accident. A cycle different from that of Table 2.7.2 can be applied according to this method. Information on which extent of the cycle is applied to the one of which location, structure, and capacity, etc. are equal to those of the tank in our country for the safety inspection and on the safety level like the situation of the occurrence etc. of the accident as the result cannot be obtained.

(reference: Concrete method of decision of internal inspection cycle based on RBI of EEMUA)

Years to becoming of the plate thickness of the bottom (or shell) constant thickness are calculated by using the corrosion rate measured on last inspection when assuming that corrosion will progress at the same speed in the future and, and years multiplied by the coefficient of reliability (0.5 for instance) are made a period until the next internal inspection. The coefficient of reliability is decided according to "Easiness of the accident to occur" and "Damage level at the accident". The easiness of the accident to occur is made points in evaluation by the potential difference etc. of the electrolytic protection, and the damage degree at the accident is classified by economy, the environment, and health effects and made points in evaluation. Combination of these two factors is used for making the points in evaluation, and based on the points the coefficient of reliability is determined. In addition, the coefficient of reliability is increased and decreased according to the degree of the precision etc. of the inspection.

2.7.3 Information on accident of overseas outdoor storage tank facilities

The accident data in the overseas outdoor tank facilities made public were collected.

(1) USA

a. Report of General Accounting Office in USA in 1995⁹⁾

"Number of aboveground storage tanks that leaked or has leaked" that United States Environment Agency presumed go up to 67,034, and it is assumed that the amount of the presumption leakage during year from the aboveground tank has been 160,000 to 200,000 kl.

b. South Dakota state, USA, in 1986¹⁰⁾

A large-scale underground water pollution by the outflow from the outdoor tank was discovered in maximum in this state city Sioux Falls. The evacuation order was put out

to the elementary school at once because Sioux Falls City National Fire Prevention and Control Administration measured the flammable gas in the Hayward elementary school and the gas of the density of 40% of the lower explosive limit field was detected on September 17, 1986. The benzene concentrations measured from the indoor air of the Hayward elementary school were about 1000 times the standard value of the American toxicity material disease registration organization.

53 investigation wells were dug up, and the pollution investigation of the shallow groundwater was done. Benzene, the ethyl benzene, the toluene, the xylene, gasoline, the fuel oil, and the jet fuel, etc. were detected. The well for five decontaminations was dug up. The possibility of the land tank of 5,845 kl (25.9m in diameter, 12.2m in height, bottom plate board thickness 6.35mm, and floating roof types) in capacity in the tank base of a pipeline entrepreneur left from the elementary school by about 140m is pointed out as a pollution source.

c. Pennsylvania state, USA, on January 2, 1988¹¹⁾

The shell of the kerosene tank of 15,100 kl (four million gallons) tore i at a dash n this state Floreffe, the wave of 10.7m (3.5ft) was caused, the oil retaining dike was destroyed, and 3,785 kl flowed out to outside of site. Part of it flowed in the Monongahela river, polluted the aquatic environment widely, and the getting the drinking water was hindered. The oil of about 1,900 kl (510,000 gallons) or more has not been collected yet. The cause is assumed to be a brittle fracture by a weld defect and the low-temperature environment in the lower part of shell.

(2)Europe

a. Beveren City, Belgian federal, ¹²⁾

·Outline

The bottom plate in the crude oil tank broke in the oil terminal of the big oil company of Beveren City, Belgian federal and 37,000 kl of the whole quantity stored were flowed out in 15 minutes. The oil that became a wave got over the oil retaining dike, and it flowed out outside the bank by about three kl. It had not been ignited fortunately though whole surface were not able to be covered because of the strong wind although coating the fire with foam was tried to oil within the bank. A part of the tank foundation was scoured and the tank inclined due to this accident. It was an accident at the time of that 15 years passed from the last internal check.

·date of occurrence; October 25, 2005

·outline of tank

form; floating roof type

size; 17m in height and 54.5m diameter

capacity; 40,000kl in capacity

dangerous article; crude oil

material; annular plate uncertainty 12.7mm thickness

bottom plate; uncertainty 6.35mm thickness

• Cause of accident

There was an inside corrosion of lunate region with 20cm in width and 35m in length in the bottom plate of about 1.5m from the shell, and the uniform corrosion was intense and plate thickness was almost 0 though there was no pitting corrosion. Big corrosion was not admitted in other parts of bottom plate. It was thought that a low part was formed in the bottom plate, water stayed, and corrosion progressed. It infiltrated the base and the naked eye was never detected though there was a small amount of leakage before a large amount of leakage. The base inclined with the crude oil that decreased by the outflow a part of strength of the base, tore according to the ditch in the bottom plate the board, flowed, and went out and scour [sare] and the main body of the tank inclined (Refer to the photograph in the under).



写真 基礎破壊の結果傾斜しているタンクの状況

b. Accident case 13 with France)

• Outline of accident

Outflow accident from bottom of tank in Ambes oil base in bordeaux outskirts. It was a small outflow at first. Afterwards, the base was destroyed, and the bottom was broken, and, the crude oil of 13,500 kl flowed out, in which 2,000 kl was getting over the oil retaining dike and flowed out outside the site. It contaminated the subterranean stream, and flowed out to the river by current action adding to also, and three rivers have been polluted over about 40 kilometers. The watch of the atmosphere around (combustible

gas, hydrogen sulfide, and aromatic hydrocarbons, etc.), the evacuation of the circumference residents, warning (alert) to the circumference offices, railways and port authorities, digging up the outflow prevention waterways, and the prevention in the rivers was done besides to the breaking out prevention with the fire-extinguishing foam. The photograph of next page shows circumstances of the accident.

- date of occurrence; January 11, 2007

- outline of tank

 - form ; floating roof type



写真：当初の小流出状況



写真：その後底板が破断した状況

c. Britain ¹⁴⁾

- Accident that was caused in weld defect (Cleveland)

Occurrence on July 21, 1999. Contents were 30% sodium cyanides. 16 tons of contents 750 tons flowed out. It was assumed that it was a cause that the local corrosion occurred in the slaggy rolling part in the weld. The effluent flowed in the Tees river from the drain system.

- Accident due to bottom corrosion (Hampshire)

Occurrence on July 14, 1999. Light quality Syrian crude oil of 400 kl flowed out from the tank at the refinery. Afterwards, two outflow accidents occurred in 19 months in the refinery (do not report to ECRA for the domestic report obligation). The cause was assumed the corrosion of the tank bottom.

- Accident due to bottom corrosion (Mild Ford Heaven)

Occurrence in July, 2005. The kerosene of 653 tons flowed out from the tank in the oil terminal. The cause was assumed the corrosion of the tank bottom. A similar accident had been caused in this tank in 2001. It was assumed that the repair had not met the demand standard (required standard).

References cited

- 1) Ministry of Land, Infrastructure and Transport land and Water Resource Bureau Water Resources Department: Water resource of 2009 version, Japan
- 2) <http://www.allcountries.org/uscensus/>
- 3) <http://www.esrl.noaa.gov/>
- 4) Science chronology 2010 version
- 5) Henry Persson and Anders Lonnermak: "Tank Fires", SP Report 2004:14, SP Swedish National Testing and Research Institute, 2004
- 6) Kevin Mould:"Is Ground Water Protected against Releases from Aboveground Storage Facilities?", International Oil Spill Conference, 1995
- 7) Chris Bashor, "Reducing the Risk of Aboveground Storage Tank Floor Leaks", Freshwater Spills Symposium, 2002
- 8) (foundation) Machine system promotion society: Feasibility Study concerning development of RBM technique for maintenance optimization of mechanical system etc., March, 2005
- 9) United States General Accounting Office: "Aboveground Oil Storage Tanks ? 44- UR and 1988
- 11) Pennsylvania state, HP
- 12) Employment, Labour and Social Dialogue, Federal Public Service: "Safety Alert : Rupture of an (atmospheric) crude oil storage tank", Document No.: CRC/ONG/013-E, November, 2006.
- 13) Arnaud Gu ?na, Emmanuelle Poupon, Mika?l Laurent: "AMBES OIL DEPOT -Crude oil tank failure 12/01/2007-", Freshwater Spill Symposia 2009.
- 14) Major accidents notified to the European Commission, England, Wales and Scotland (<http://www.hse.gov.uk/comah/eureport/>)

Chapter 3 Impact assessment when inspection cycle is extended

In order to evaluate the influence when the basic inspection cycle of the safety inspection of the outdoor storage tank facilities was changed, the spill accident was verified how to increase, and to influence the safety of the tank like the decrease in seismic performance etc. by using past data.

3.1 Impact assessment when inspection cycle is extended (inside corrosion)

It is examined mocking by using the data of the corrosion depth measured at the past internal inspection of new law tank of 10,000 kl or more in capacity how the number of spill accidents caused by the penetration hole according to the inside corrosion on the bottom plate increases when the inspection cycle is extended. It is defined with a spill accident here that it is forecast that inside corrosion progresses by the fixed rate and the plate thickness of the bottom plate becomes 0mm. In an actual tank, it is thought that the spill accident occurs on a condition (early stage) that is thicker than the bottom plate thickness which becomes 0mm due to corrosion since there are the hydraulic pressure, the residual stress, and coming to the surface of the bottom plate from the base etc.. And, there is the possibility of change of the corrosion rate in the passing age (Figure 3.1.1). Simple assumption is taken that the occurrence condition of the accident is assumed to be a plate thickness 0mm, and the corrosion rate wants to be constant, though it is optimistic, because of a virtual examination to the end here. However, at an actual management such an idea is not suitable because it allows the large-scale spill accident, but it is necessary to set the room for safety.

3.1.1 Data used to estimate years where bottom plate penetrates due to inside corrosion

- the maximum inside corrosion depth in each opening for internal inspection
- the minimum remainder plate thickness after it repairs being presumed from repair specification to inside corrosion (When how many mm or more be the inside corrosion depth, is the overlaying repair executed?) when each opening it.
- period of each opening for internal inspection
- design bottom plate thickness of tank (The allowance is not considered in this examination though there is a case where the plate having the plus allowance more than the design plate thickness is used in an actual tank).

3.1.2 Method of presuming years where bottom plate penetrates due to inside corrosion

When the inspection cycle is extended, years where the bottom plate penetrates due to inside corrosion are presumed by the following methods. It is assumed that there is no

corrosion on the back side of the maximum, inside corrosion part.

(1) The data of 3.1.1 is collected from the data of 617 new law tanks of 10,000 kl or more in capacity (the abolished one is included) that Hazardous Materials Safety Techniques Association is preserving.

(2) The data of 70 tanks which have been reported one measured big inside corrosion depth has been extracted (Refer to reference-1 for the extracted data).

(3) With the annular plate and the bottom plate, the minimum remainder plate thickness (presumption minimum remainder plate thickness after repaired) is presumed from the inside corrosion depth of this opening for inspection utilizing the repair specification to inside corrosion based on the data of past opening.

(4) The corrosion rate is estimated from the remainder plate thickness due to inside corrosion from the presumption minimum remainder plate thickness at opening last time or the design plate thickness and the presumption minimum remainder plate thickness after it was repaired at opening this time. Whether in how many years the remainder plate thickness becomes 0mm is calculated when the inspection cycle is extended in the case that corrosion progresses by the estimated corrosion rate.

(5) The part where the maximum inside corrosion had been found at last opening was not necessarily a part of the presumption minimum remainder plate thickness. The inside corrosion rate during opening last time and this time was calculated from this by the following two values (refer to Figure 3.1.2).

A:Presumption lower bound value (method of calculating direction where forecast penetration years shorten) calculated as causing the maximum, inside corrosion at opening this time in part that was design plate thickness after it was repaired at opening last time (Figure 3.1.2 dotted line).

B:Presumption upper bound value (method of calculating direction where forecast penetration years become long) calculated as causing the maximum, inside corrosion at opening in part of the presumption minimum remainder plate thickness after it was repaired at opening last time (Figure 3.1.2 solid line).

(6) The presumption years when the remainder plate thickness becomes 0mm at the time of each opening are calculated for one tank, and the one with a shortest years is made the penetration year due to inside corrosion of the bottom plate of a tank concerned (refer to Figure 3.1.4).

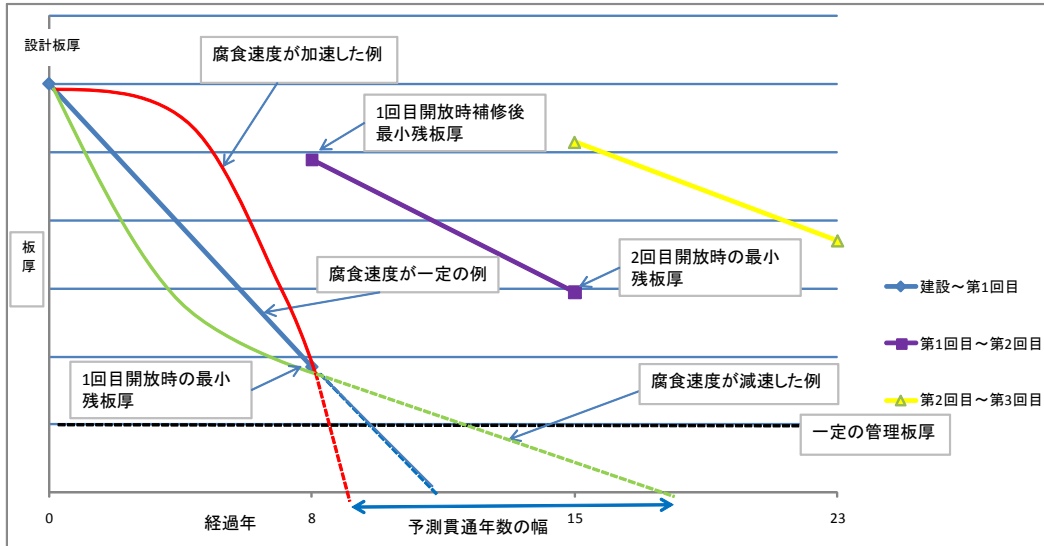

Points of concern for presumption at penetration years of bottom board due to inside corrosion
 ?When it is thought, and it designs and board thickness minimum connects board thickness by the straight line the change (blue solid line) with the first opening times, the corrosion rating of the bottom board might grow. Therefore, it is necessary to consider the safety allowance in actual management as for the corrosion rating in the future it is likely to become large for the corrosion rating (blue solid line) connected by the straight line (red dotted line).
 ?When it undertakes actual management because it is thought that there are coming to the surface of the bottom plate from the hydraulic pressure, the residual stress, and the base etc. , and the outflow is generated by board thickness whose bottom board thickness is thicker than 0mm in an actual tank, constant management board thickness is necessary.
 ?It is necessary to note the difference from an actual management method from the above-mentioned reason though the corrosion rating guesses years when the bottom board thickness becomes 0mm because it assumes it is constant because it is difficult to consider the change in the corrosion rating in this examination.

図 3.1.1 腐食速度の変化例イメージ図

内面 (底板)		設計板厚	経過年	開放周期	最大内面腐食量	開放時最小板厚	内盛基準	補修後最大腐食	補修後最小板厚	腐食速度 (mm/年)	貫通推定年数	板取割合 (%)	コーティング有無		
完成検査	S56.9.2	12	0	0	0				12						
開放検査	S63.4.27		6	6.7	1	11		1	11	0.15	80	0	1		
	H9.3.21		15	8.9	2.5	9.5	1.5	1.4	10.6	0.17	~ 0.28	42.9	~ 64.7	0	1
	H17.6.15		23	8.2	6.9	5.1	1.5	1.4	10.6	0.67	~ 0.84	14.3	~ 15.8	1	1



図 3.1.2 タンクの開放ごとの内面腐食の履歴の例

(7) The corrosion rate differs at the time of each opening, and the fluctuation band of the corrosion rate has to be considered when penetration is forecast. The ratio of the maximum value to the minimum value (bottom plate 1.4 and annular plate 1.7) of the one that the maximum corrosion rate of each tank obtained at the time of each opening was averaged to the number of tanks (Table 2.4.2) are assumed as the width. In civil standard EEMUA of Europe, the value of 2.0 (reciprocal of "Reliability coefficient 0.5") is indicated as a fluctuation band to the corrosion rate (2.7.2 references). Because this penetration forecast is virtually examined, the above-mentioned assumption thought to be almost real was used. Therefore, it is necessary to note that it is not the one of showing the fluctuation band that should be considered in practical system. Even if the highest corrosion rate calculated as a result was 1.5mm/year (Figure 3.1.3), it was below the corrosion rate (1.5-2.6mm/year: Figure 2.4.1) of the case where inside corrosion progressed rapidly and that arrived at spill accident.

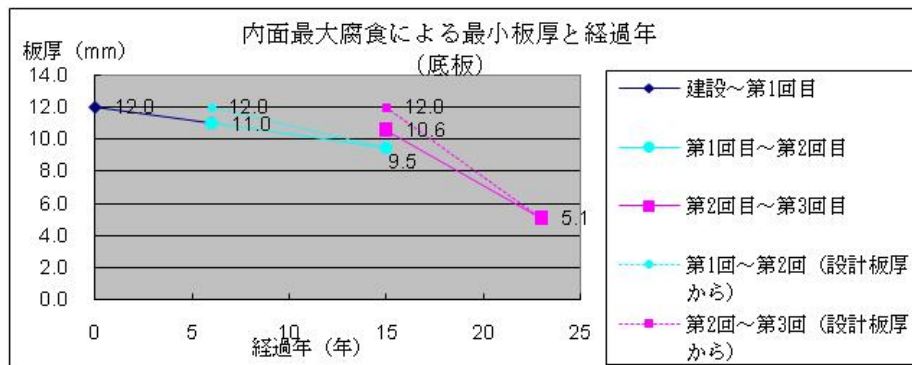

図 3.1.3 収集し分析に用いたデータ中で内面腐食速度の大きな事例

3.1.3 Penetration year's estimated result due to inside corrosion

The age to becoming of board thickness at the corrosion history of each tank 0mm earliest of the new law tank of 10,000 kiloliters or more in capacity was calculated from the history data of inside corrosion by the method of the preceding clause. The forecast year of penetration due to inside corrosion when the value is assumed for acceleration to be able to exist constantly the measurement of concerned in the tank in the past to the corrosion rating compared with (Figure 3.1.1 red line) is indicated in Table 3.1.2 in Table 3.1.1 in the year of presumption of penetration due to inside corrosion when assuming being acceleration from the value the measurement of concerned in the tank in the past to the corrosion rating (Figure 3.1.1 blue line).

It is necessary to note that assumption that lengthened the presumption year about the following respect (Danger is evaluated small) was used about the result.

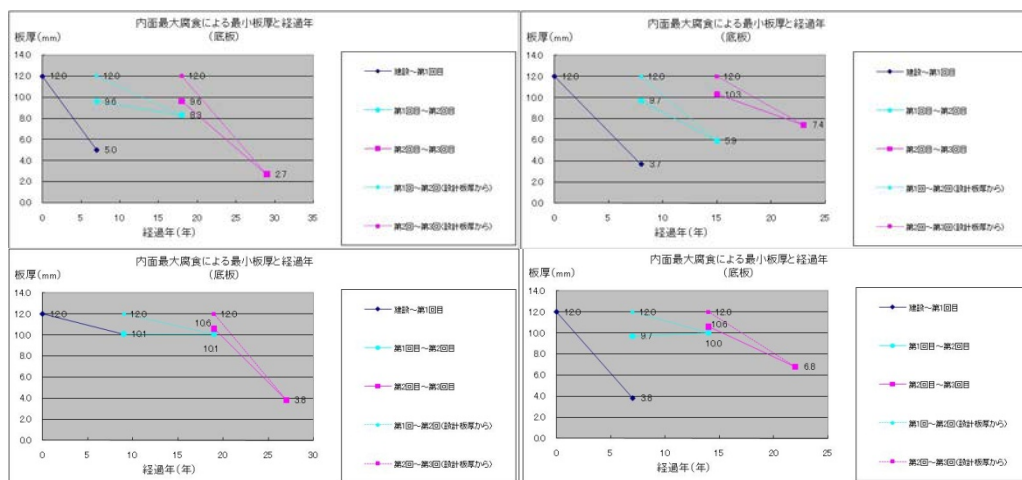
- ・Years when board thickness had become 0mm were calculated.
- ・The back corrosion was assumed it not was and calculated.
- ・Do not consider the change of the inside corrosion speed more greatly than the average.

表 3.1.1 腐食速度が測定値から加速することがないと仮定した場合の内面腐食による貫通の推定年

年	内面腐食速度の推定下限値を用いた推定			内面腐食速度の推定上限値を用いた推定		
	アニュラ板	底板	累計	アニュラ板	底板	累計
8 以下	0	0	0	0	0	0
～9	0	0	0	0	0	0
～10	0	0	0	0	0	0
～11	0	1	1	0	1	1
～12	0	1	2	0	2	3
～13	0	2	4	0	2	5
～14	0	1	5	0	0	5
～15	0	1	6	0	4	9
～16	0	3	9	0	3	12

表 3.1.2 腐食速度が測定値と比較して一定の加速をすると仮定した場合の内面腐食による貫通の推定年

年	内面腐食速度の推定下限値を用いた推定			内面腐食速度の推定上限値を用いた推定		
	アニュラ板	底板	累計	アニュラ板	底板	累計
8 以下	0	1	1	0	1	1
～9	0	2	3	0	4	5
～10	0	2	5	0	0	5
～11	0	2	7	0	6	11
～12	0	5	12	1	3	15
～13	0	3	16	2	4	21
～14	1	2	19	0	2	23
～15	0	4	23	1	5	29
～16	2	2	27	1	3	33

3.2 Impact assessment when inspection cycle is extended (back side corrosion)

It is examined mocking by using the data of the corrosion depth measured when it was opened in the new law tank of 10,000 kl or more in capacity in the past how the number of spill accidents caused by the penetration hole according to the back side corrosion on the bottom plate increases when the inspection cycle is extended. It is assumed with a spill accident here that it is forecast that the back side corrosion progresses by the fixed velocity and the plate thickness of the bottom plate becomes 0mm. In an actual tank, it is thought that the spill accident occurs on a condition (earlyer stage) that is thicker than 0mm of the bottom plate thickness of which becoming due to corrosion is forecast since there are coming to the surface of the bottom plate from the hydraulic pressure, the residual stress, and the base etc. And, there is the possibility of change of the corrosion rate in the passing age (Figure 3.1.1). Simple assumption is taken that the occurrence condition of the accident is assumed to be a plate thickness 0mm, and the corrosion rate wants to be constant, though it is optimistic, because of a virtual examination to the end here. However, at an actual management such an idea is not suitable because it allows the large-scale spill accident, but it is necessary to set the room for safety.

3.2.1 Data used to estimate years where bottom plate penetrates due to the back side corrosion

- ・The remainder plate thickness of the maximum back corrosion part detected by fixed point metrology when each opening it
- ・Ratio of the maximum back side corrosion depth detected by fixed point metrology and actual, maximum back side corrosion depth (3.2.2 references)
- ・Minimum plate thickness after it was repaired at each opening

- Period of each opening
- Bottom design plate thickness of tank (The allowance is not considered in this examination though there is a case where the plate having the plus allowance more than the design plate thickness is used in an actual tank).

3.2.2 Comparison between the maximum back side corrosion depth detected by fixed point metrology and actual, maximum back side corrosion depth

In the measuring method of the plate thickness of the tank bottom of a specific outdoor storage tank facilities, there are a fixed point metrology and a continuous plate thickness metrology. There are two kinds of measuring methods for the fixed point metrology, one is shown in paragraph 56 notification and the other is shown in "Earthquake countermeasures of the outdoor storage tank facilities" (fire fighting [abuna] the 169th notification (Hereafter, it is said, "The 169th notification") on December 25, 1979) (The measuring method was shown in reference-3). These measuring methods are the methods of measuring plate thickness discrete aiming to manage the back side corrosion of the tank bottom in the tendency.

On the other hand, the technology that can continuously measure the thickness of the plate of the tank bottom over the wide range is developed as a new technology, and management to the bottom back side corrosion has come to be executed by the method of measuring plate thickness that uses this technology in some owner and etc.. This measuring method is shown in "Operation concerning the plate thickness measurement of specific outdoor storage tank bottom by the method of measuring continuous plate thickness" (fire fighting [abuna] No.27 on March 28, 2003), and the measurement intervals is 30mm or less. The measurement is possible at intervals of 30mm in the device running direction and of 5mm in an orthogonal direction of the running direction in the continuous plate thickness weighing device operated now. Because the back side corrosion of the bottom of tank often occurs locally as seen in 2.5.1 and the corrosion part cannot be checked visually with different from inside corrosion, it is thought that the interval at discrete measurements in the fixed point metrology is big compared with the size of the local corrosion. Therefore, there is a possibility that the maximum back side corrosion depth occurred actually is larger than that of the detected maximum back side corrosion depth in the fixed point metrology. On the other hand, it is necessary to presume the actual, maximum back side corrosion depth from the result by the fixed point metrology which was mainly used in a past safety inspection to estimate the penetration year due to the back side corrosion because

By analyzing through comparing the maximum back side corrosion depth detected by

the fixed point metrology and obtained from the result of a measurement of the continuous plate thickness metrology about the same tank, the ratio of the maximum back side corrosion depth by the difference of the measuring method is calculated, and so, the actual, maximum back side corrosion depth is calculated by the next expression from the maximum back side corrosion depth detected by the fixed point metrology when safety was inspected in the past.

The presumption maximum back side corrosion depth

$$= \text{Ratio by difference of maximum back side corrosion depth} \times \text{the maximum back side corrosion depth detected by fixed point metrology}$$

In the calculation of the ratio by the difference of the measuring method, the corrosion depth by the continuous plate thickness metrology was used as an actual, maximum back side corrosion depth.

(1) Method of calculating ratio by difference of measuring method

a. 37(12 data; for only annular plate) bottom plate thickness data of the new law tank of 1,000 kl or more in capacity that had been measured by the continuous plate thickness metrology that used the supersonic wave (Hereafter, it is said, "continuous plate thickness data") was collected.

b. Extracting the measuring data of the part shown to the annular plate and bottom plate by the 56th notification and the 169th notification, respectively, from the continuous plate thickness data, minimum value of plate thickness is calculated when assuming measuring by each measuring method of the extracted data.

c. Assuming that the location of measurement shifted in which the fixed point was set when the data of the fixed point measurement point was extracted from the continuous plate thickness data, five kinds of extraction parts of each plate were set (refer to Figure 3.2.1 and Figure 3.2.2 for the setting method of the extraction point).

d. The mode value of the continuous plate thickness data was assumed to be initial plate thickness in consideration with the allowance of initial plate thickness.

e. The maximum back side corrosion depth calculated from the continuous plate thickness data and the maximum back side corrosion depth of each tank by each measuring method of the 56th notification and the 169th notification are calculated.

f. Using the maximum back side corrosion depth obtained from the above-mentioned method at e, for the annular plate and bottom plate, in the abscissa the maximum back side corrosion depth of the continuous plate thickness metrology, and in ordinate that of the point shown by the fixed point metrology is taken, respectively. And the ratio of the maximum back side corrosion depth by the difference of the measuring method is calculated for the regression line.

- ・アニュラ板では、起点を円周方向へ100mm ずつ4回ずらした^{※1}。
- ・底板では、起点をX方向、Y方向にそれぞれ±150mm ずらした^{※2}。

屋外貯蔵タンクの昭和52年消防危第56号に基づく測定方法



図 3. 2. 1 データ抽出箇所の設定方法(56号通知を模擬した場合)

- ・アニュラ板の側板から500mm 範囲では、起点を隣接する測定点との間隔を5等分した各位置にずらした^{※1}。500mm 以外の範囲では、起点を円周方向へ100mm ずつ4回ずらした^{※2}。
- ・底板では、起点をX方向、Y方向へそれぞれ±150mm ずらした^{※3}。

屋外貯蔵タンクの昭和54年消防危第169号に基づく測定方法

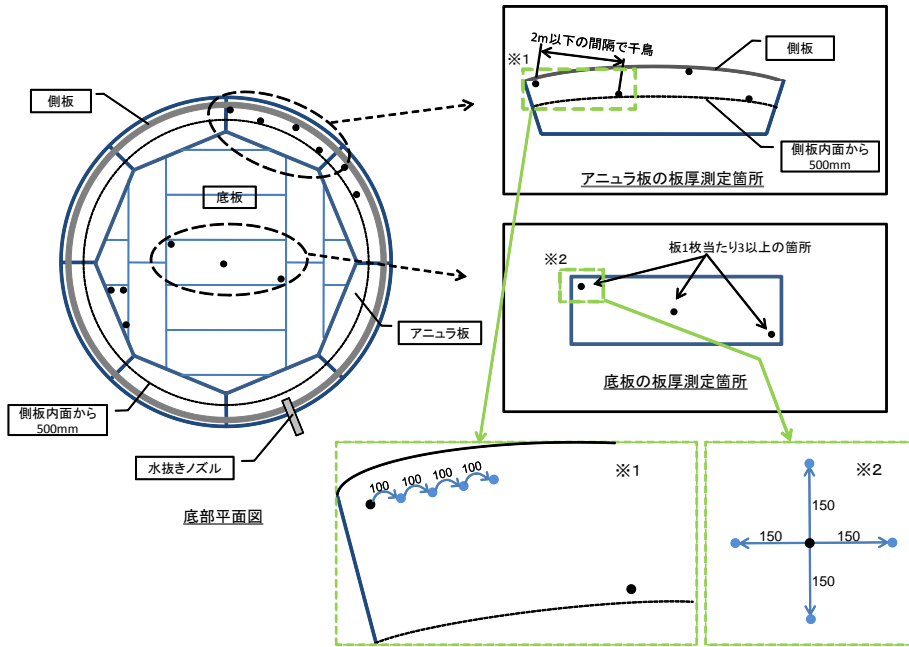

図 3. 2. 2 データ抽出箇所の設定方法(169号通知を模擬した場合)

(2) Regression analysis result of the back side corrosion depth detected by fixed point metrology and the back side corrosion depth by continuous plate thickness metrology

The result of the analysis is shown in Figure 3.2.3 and Figure 3.2.4 (□ is a mean value of the result by fixed point measurement method in which five kinds of points of a tank are set, and a vertical segment shows the scattering by the method of setting the fixed point, in the figures). In both figures, the left one simulates the 169th notification, the right is a result for simulating the 56th notification. The relation between the back side corrosion depth detected by fixed point metrology using the mean value and the one by continuous plate thickness metrology was expressed regression line, from which inclination the ratio how many times the real maximum corrosion depth of the one by fixed point metrology was evaluated from an average viewpoint. The tank parameter etc. of the plate thickness data used for this analysis is shown in references-4.

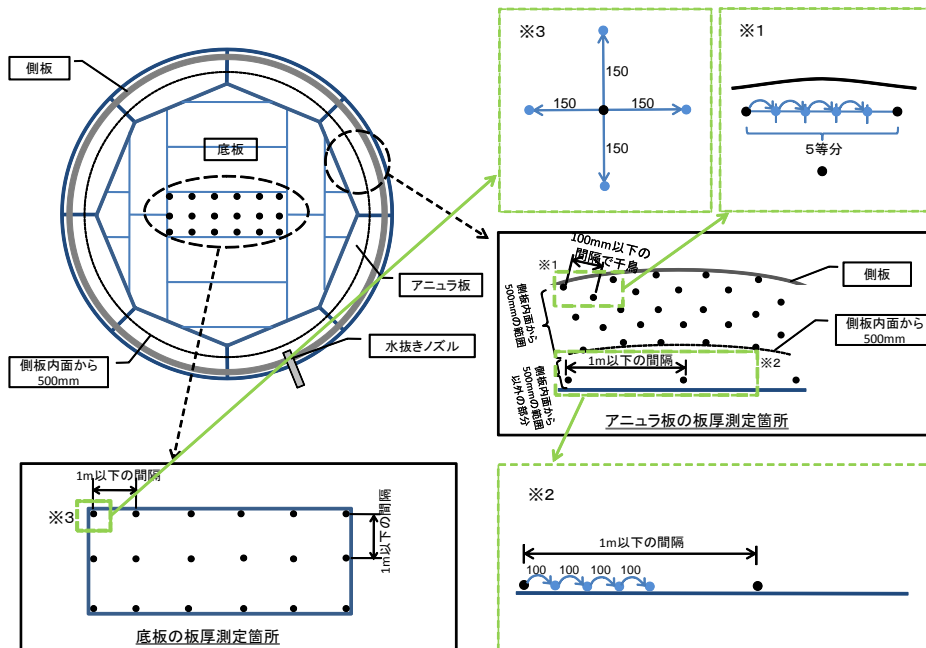

図 3.2.3 アニュラ板の定点測定結果と連続板厚測定結果の相関分析結果（5通りの抽出箇所設定方法による平均を■で、結果の幅を垂直の線分で示す。）



図 3.2.4 底板の定点測定結果と連続板厚測定結果の相関分析結果（5通りの抽出箇所設定方法による平均を■で、結果の幅を垂直の線分で示す。）

It is thought that the real maximum back side corrosion depth of the tank bottom is multiplication of the coefficient (reciprocal of the inclination of the regression line) in Table 3.2.1 by the maximum back side corrosion depth obtained by the fixed point metrology on the average.

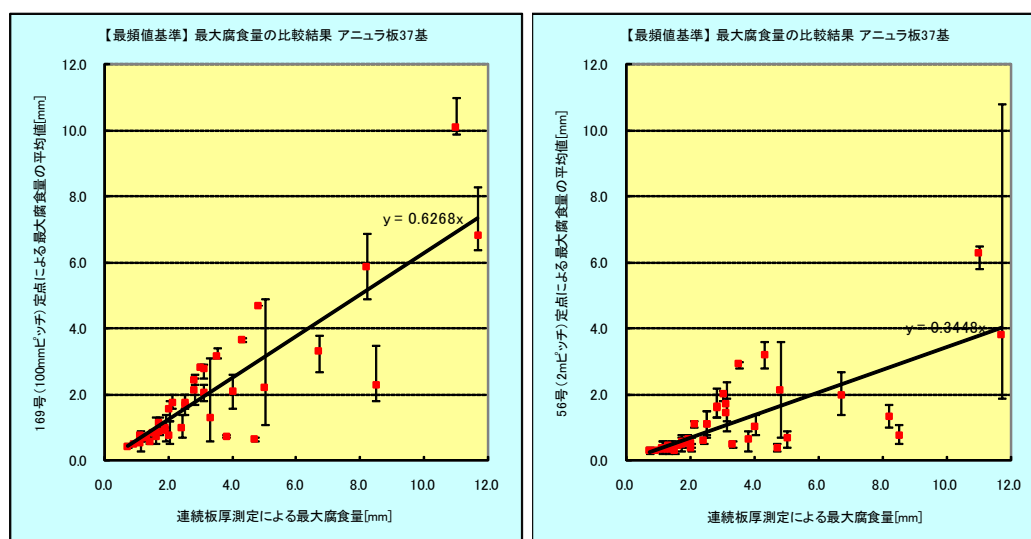
表 3.2.1 定点測定法による裏面腐食深さから想定される最大裏面腐食深さの算出係数

	56号通知による定点測定	169号通知による定点測定
アニュラ板	2.90	1.59
底板	3.77	1.95

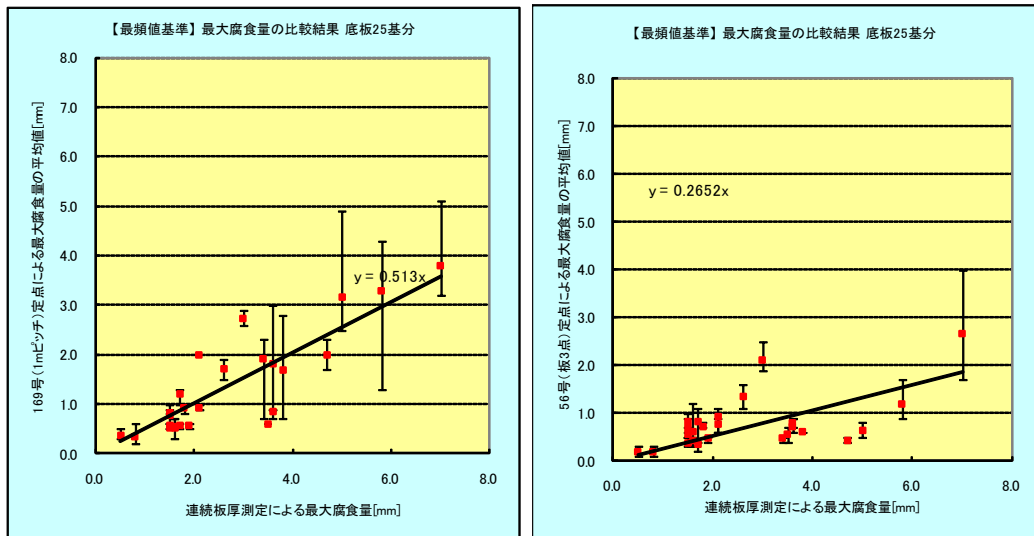
3.2.3 Method of presuming years where bottom plate penetrates due to the back side corrosion

When the inspection cycle is extended, years where the bottom plate penetrates due to back side corrosion are presumed by the following methods. It is assumed that there is no inside corrosion at the maximum, back side corrosion part.

- (1) The data of 3.1.1 is collected from the data of 617 new law tanks of 10,000 kl or more in capacity (the abolished one is included) that Hazardous Materials Safety Techniques Association is preserving.
- (2) The data of 50 tanks which have been reported one measured big inside corrosion depth has been extracted (Refer to reference-2 for the extracted data).

(3) With the annular plate and the bottom plate, the remainder plate thickness after repaired due to back side corrosion is presumed from the minimum plate thickness detected by fixed point metrology and the minimum plate thickness after repaired on each opening,

(4) For the annular plate and the bottom plate, the maximum back side corrosion depth assumed by the continuous plate thickness metrology is calculated by multiplying the ratio in Table 3.2.1 to the maximum back corrosion depth detected by the fixed point metrology on each opening.

(5) The corrosion rate is obtained from the minimum plate thickness after it was repaired of opening last time and the minimum plate thickness detected by the fixed point measurement of opening this time. Whether in how many years the remainder plate thickness becomes 0mm when the inspection cycle is extended assuming that corrosion progresses by the obtained corrosion rate is calculated.

(6) Based on the idea of (4), whether in how many years the remainder plate thickness becomes 0mm when the inspection cycle is extended is calculated. Corrosion rate required for calculation were obtained from minimum plate thickness that assumes the case where the continuous plate thickness metrology was executed on last opening and this time opening, respectively, and corrosion rate was presumed constant.

(7) According to (5), (6), following two estimated results are obtained.

?Fixed point metrology maximum corrosion depth measure assume Figure solid line fixed point measurement presumption fixed point measurements statistical expect maximum corrosion depth presume Figure dotted line continuous board thickness measurement assumption presumption tank open remainder board thickness become presumption years calculate.

(8) The one with a short years of each approximation process is made the penetration year due to the back corrosion of the bottom board of a tank concerned (Refer to Figure 3.2.6 for the procedure of the examination).

表面(底板)	設計板厚	経過年	開放周 期	定点測定に よる表面最 大腐食量	定点測定最 小板厚	補修後最 小板厚	連続板厚測 定を想定し た補正係数	連続板厚測 定による予 測値	定点測定に よる直通予 測年数	連続板厚測 定による直 通予測年数	板厚測定方 法	板の取替 割合(%)
完成検査	S55.12.22	12.0	0	0.0	12.0		169号:1.95 58号:3.77					
開放検査	S61.6.9	5	5.5	0.2	11.8	11.8	不明		327.95		不明	0
	H3.7.31	10	5.1	0.6	11.4	11.4	1.95	10.83	151.8		169号	0
	H12.3.27	19	8.7	4.0	8.0	9.2	1.95	4.20	29.0	14.2	169号	4
	H20.10.6	27	8.5	7.2	4.8	9.9	1.95	-2.04	17.8	5.7	169号	13



図 3.2.5 タンクの開放ごとの裏面腐食の履歴の例

3.2.4 Penetration presumption result due to the back side corrosion

The age to becoming of plate thickness 0mm earliest at the corrosion history of each tank of the new law tank of 10,000 kl or more in capacity was calculated from the history data of the back side corrosion by the method of the preceding clause. The presumption year of penetration due to the back corrosion respectively of presumption by the fixed point metrology that was assumed being acceleration from the value to which the corrosion rating was measured in a tank concerned in the past in consideration of the calculation accuracy of the corrosion rating by the fixed point metrology (Figure 3.1.1 blue line), and obtained by 3.2.3 and presumption by the continuous board thickness measurement assumption is indicated in Table 3.2.2.

It is necessary to note that assumption that lengthened the presumption year about the following respect (Danger is evaluated small) was used about the result.

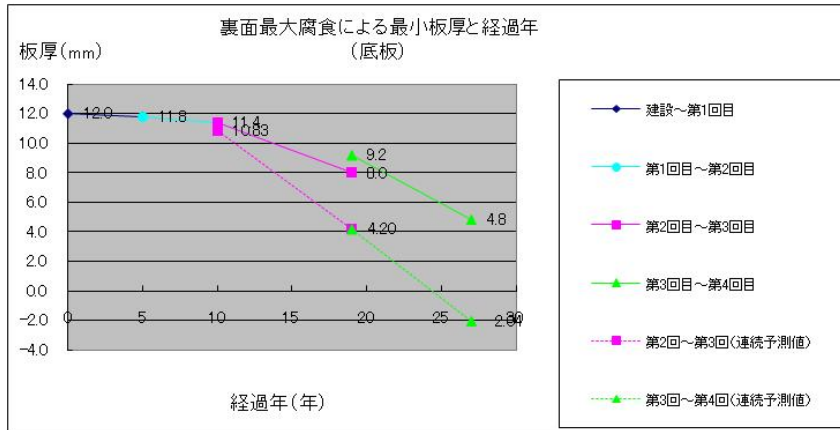
- ・Years when board thickness had become 0mm were calculated.
- ・Inside corrosion was assumed it not was and calculated.
- ・Do not consider the change of the back corrosion speed.

表 3.2.2 腐食速度が一定と仮定した場合の裏面腐食による貫通の推定年

年	定点測定			連続板厚測定想定		
	アニューラ板	底板	累計	アニューラ板	底板	累計
8以下	0	0	0	0	3	3
～9	0	0	0	1	2	6
～10	0	2	2	0	1	7
～11	0	0	2	1	1	9
～12	1	0	3	0	1	10
～13	0	0	3	2	0	12
～14	0	0	3	0	2	14
～15	0	0	3	0	1	15
～16	0	0	3	1	1	17

- Reason to have done continuous plate thickness measurement assumption

It is understood that the maximum back side corrosion depth measured by a continuous plate thickness metrology which is near the one occurred on the bottom plate of the tank actually becomes larger by ratio shown in Table 3.2 than the maximum back corrosion depth measured by the fixed point metrology on the average. Therefore, it comes to evaluate excessively the penetration year of the bottom plate due to the back side corrosion by using the maximum back side corrosion depth measured by the fixed point metrology as it is (come to undervalue the number of penetration when the inspection

cycle is extended). Then, the evaluation was done assuming that the continuous plate thickness metrology was executed by using the result of Table 3.2.1 to evaluate nearer to the realities.

References cited

1) Kouiti Tamura, Hiroyuki Haga, Yosio Tuji, Shigeo Kikkawa, Naoya Kasai, Kazuyosi Sekine: Probability statistical research on the oil tank bottom plate back side corrosion (the first report), pressure technology, No. 1, Vol.46, August, 2007

3.3 Impact assessment when inspection cycle is extended (seismic performance)

3.3.1 Tank bottom breaking case due to earthquake

Figure 3.3.1 shows the photograph on the back side of annular plate of the tank (accident case with 2.6.1 d) broken by Miyagi-ken-oki Earthquake.



図 3.3.1 昭和 53 年宮城県沖地震で破断したタンクのアニュラ板裏面の腐食状況

Figure 3.3.2 shows the macro photography of the part A and B in above Fig. 3.3.1. In part A it can be confirmed for the micro-crack to connect and to grow up to a long crack. On the other hand, in part B the crack wasn't not found in the part without corrosion though there was a crack in the corroded part. So, it is thought that the local corrosion influences breaking the bottom plate from this.

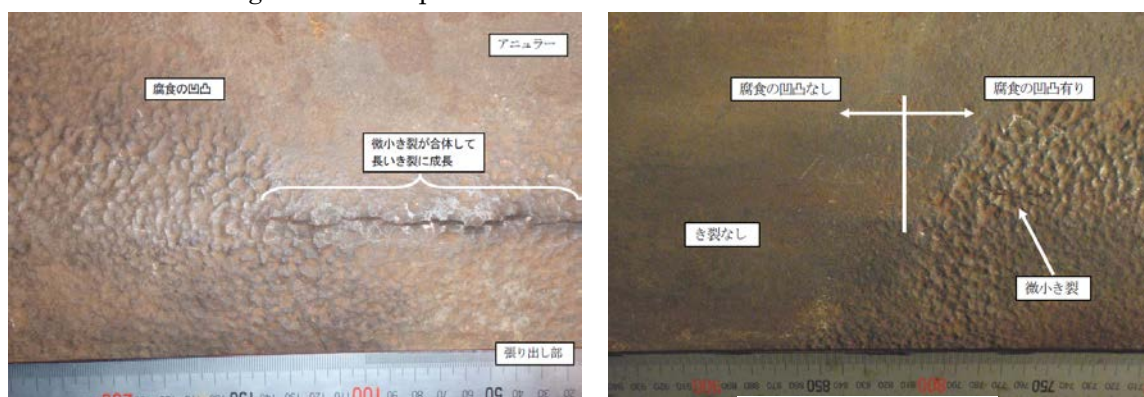

A部の拡大写真

B部の拡大写真

図 3.3.2 図 3.3.1 の A 部及び B 部の拡大写真

3.3.2 Concept of seismic performance of bottom of tank

(1) Idea of securing seismic performance as the entire tank due to power horizontal proof

When a high-level seismic ground motion is received, the tank shows behavior of coming

to the surface (Figure 3.3.3). Therefore, a high stress acts on annular parts, and the plastic strain is caused (Figure 3.3.4).

At this time, the tank is damaged as for

energy-absorbing capacity < input energy due to the plastic strain.

In the tank in a specific outdoor tank reservoir, it is provided to manage the board thickness of [anyura] (The plastic strain energy is proportional to the second power of board thickness) so as not to become such a condition in the fire fighting law. Necessary [anyura] board thickness is calculated by the mean value of the tank all surroundings because it thinks about behavior in the entire tank. It is not thought easily, and is possible to become a corrosion situation in which the mean value of all surroundings falls below necessary board thickness because of the part of the corrosion described by 2.5 of board thickness necessary for earthquake resistance that the necessity for considering the influence of the cycle extension as long as it doesn't greatly extend it at a present cycle is a little in the new law tank seen from a present corrosion situation.



図 3.3.3 タンクの浮き上がり挙動



図 3.3.4 アニュラ部の変形のイメージ

(2) Idea of earthquake resistance of local corrosion part

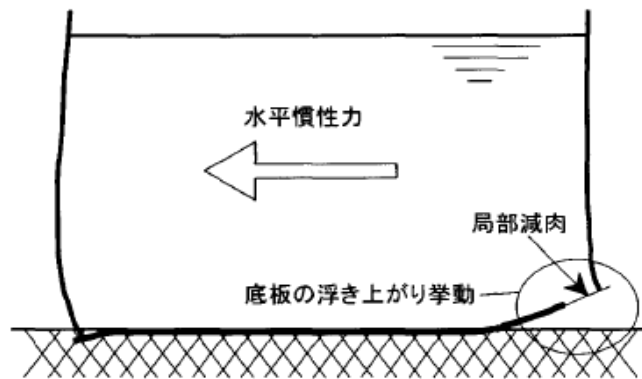
When the inspection cycle is extended, the progress of the local corrosion is feared because the interval of the repair chance is postponed. When the local corrosion progresses deeply, fear that damage is partially caused because the warp concentrates when a big repetition transformation is received is thought. One trial calculation was done this time though the point of the evaluation whether to cause damage in the part at the earthquake had not been established to a determinate technique if the local corrosion progressed up to the depth of which extent now. As for the trial calculation method, is it a reference? It showed in five. The numerical result described from there are future tasks like the verification of the accuracy of the accumulation of the validity of not the established one but the assumption used and tiredness and the corrosion shape etc. to the following clause, too refers to this computational method to the end.

3.3.3 ..low.. probabilistic assessment of cycle fatigue fracture in local corrosion part (trial calculation example)

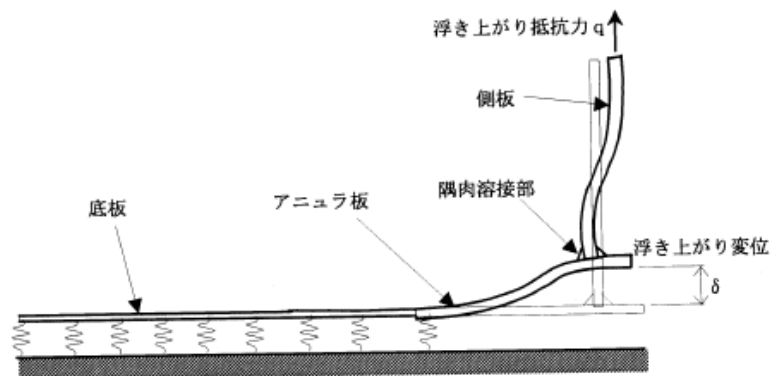
As for the possibility of cycle fatigue fracture, it is ..low.. reference against the back corrosion of the example of the shape of cross section of deep corrosion with the continuous board thickness measurement result. It calculated it provisionally concerning safety by the showed in five method. The result is as shown in Table 3.3.1. Figure 3.3.5 shows the calculated corrosion shape.

The possibility of destruction was shown partially of the shape of the back corrosion found in the past when evaluating it due to the corrosion of the ditch (It is shown by × in Table 3.3.1). Half of initial board thickness such corrosion is corrosion of depth (value close to one by the line of b/ρ) to the level. That is, when corroding the half of initial board thickness even to the level progresses, and it has extended like the line, the possibility of cycle fatigue fracture ..low.. is thought. However, it was assumed that it did not destroy it for these in the evaluation of the corrosion of the hole. It is possible to say by no damage of earthquake resistance if corrosion is [tenjou]. It can be said that attention will be needed from needing attention to the flat type of corrosion to earthquake resistance when half of initial board thickness corrosion progresses from the above-mentioned to the level. It sees statistically, and a big tank of the uneven settlement of the base is 1 that the bottom corrosion is comparatively intense) 2.) A big base of the uneven settlement is assumed there is a partial ruggedness as the factor, and it is assumed that corrosion progresses easily from becoming a condition not homogeneous electrically repeat moist and dryness by the back of the bottom board in ruggedness surroundings. In this case, the part of thin board thickness that has subsided the base and receives corrosion exists. At this time, a big stress is generated in

thinning [anyura] board or bottom plate at the receiving payment and the earthquake of the liquid. The trial calculation result becomes constant reference from this even against besides [anyura]. This method treats the evaluation method and the result referring because there is not the one established as previously described but a problem that should be examined.

References cited

- 1)The Ministry of Public Management, Home Affairs, Posts and Telecommunications Fire and Disaster Management Agency: March, investigation examination report and 2002 concerning method of specific outdoor tank reservoir of calculating cycle of open
- 2)The Ministry of Public Management, Home Affairs, Posts and Telecommunications Fire and Disaster Management Agency: March, investigation examination report and 2008 concerning residual life prediction of outdoor tank reservoir



図 3.3.5 表 3.3.1 で耐震性を試算した裏面腐食形状

● 孔食 4 (タンク 4 (供用年 21 年)) $b = 13.1, \rho = 8.6$



● 孔食 5 (タンク 5 (供用年 28 年)) $b = 11.8, \rho = 9.5$

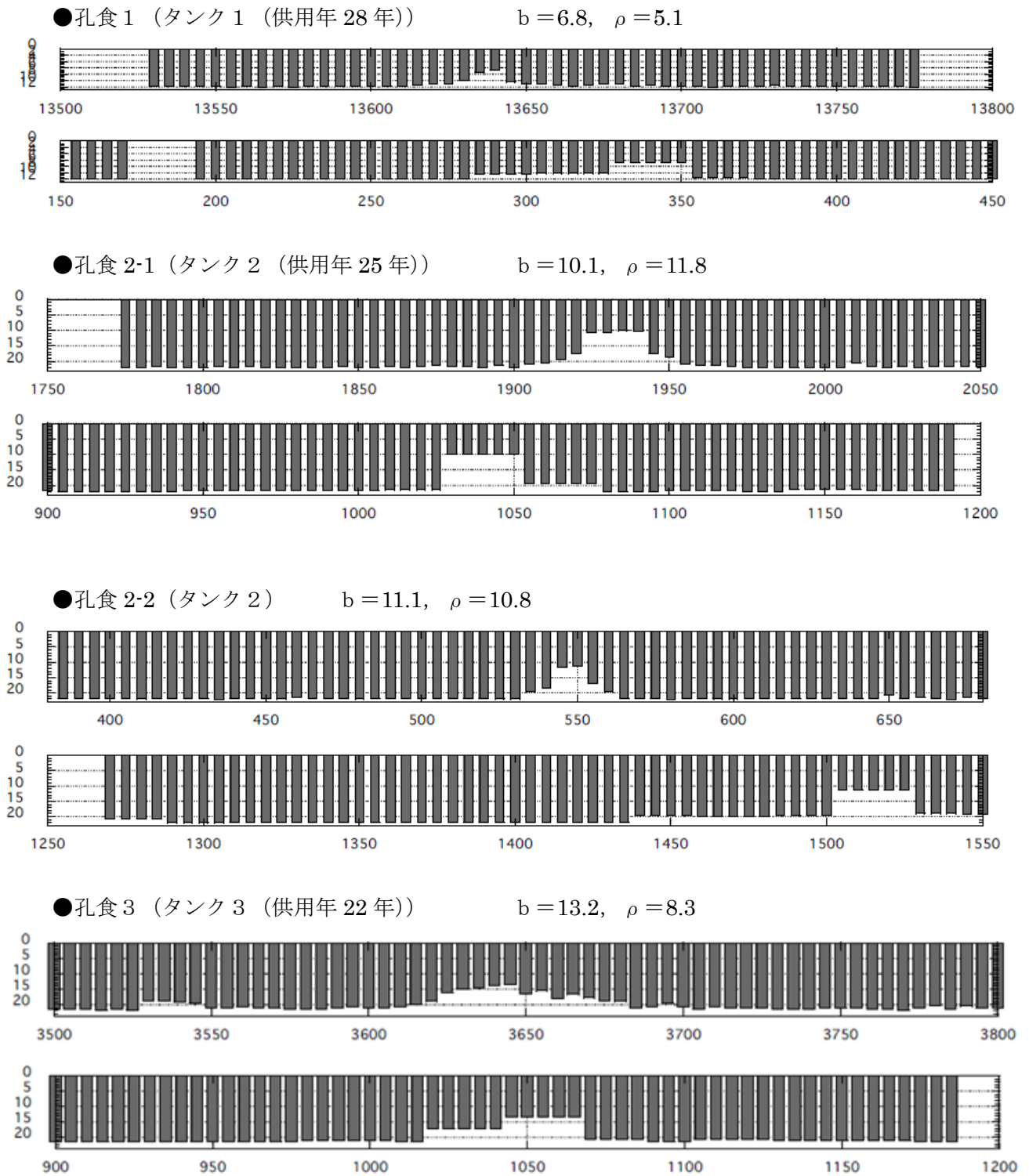
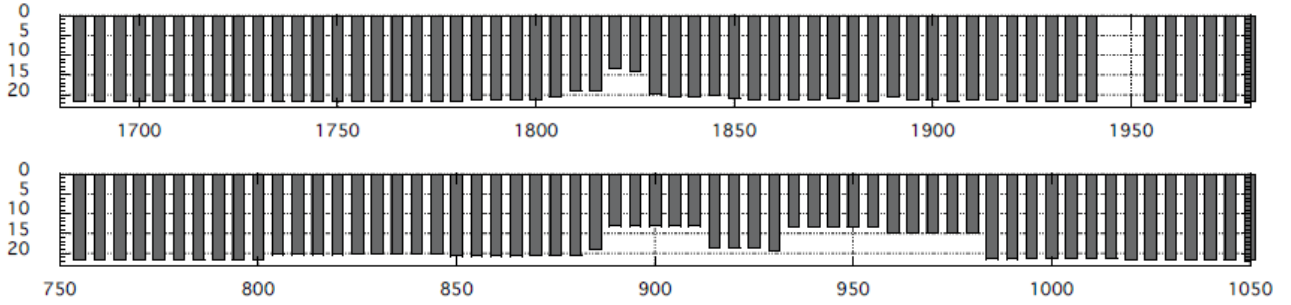
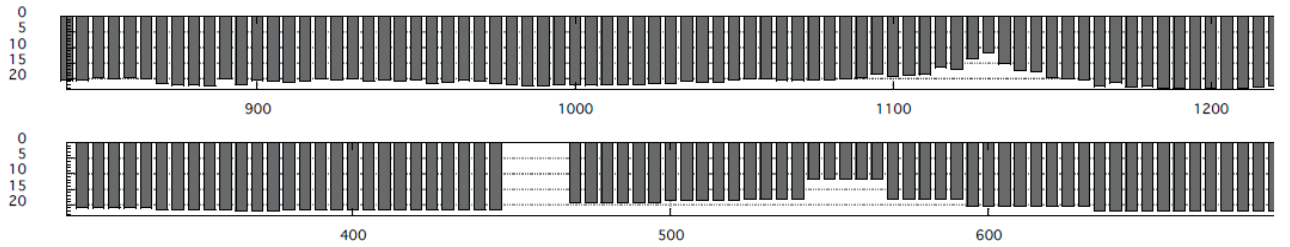

● 孔食 6-1 (タンク 6 (供用年 25 年)) $b = 7.3, \rho = 4.5$

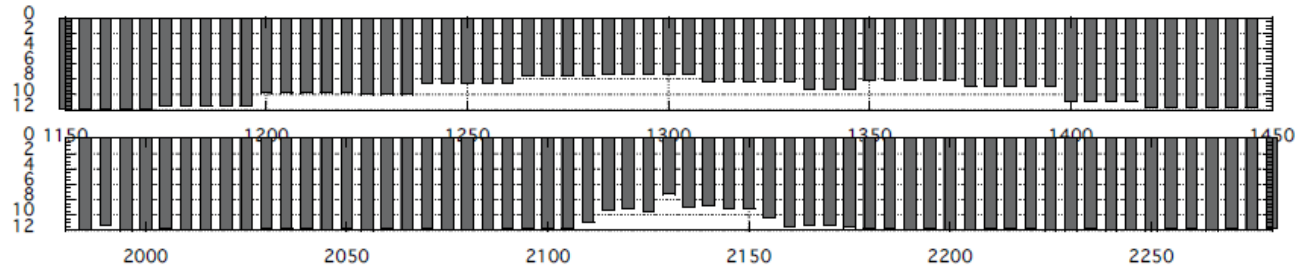

● 孔食 6-2 タンク 6 (供用年 25 年) $b = 7.3, \rho = 4.6$



図 3.3.5 表 3.3.1 で耐震性を試算した裏面腐食形状 (つづき)

3.4 The impact statement (weld defect) when the inspection cycle is extended

It is 1 as a result of investigating the number of tanks from which crack * was discovered when opening is inspected in two years of 1996 the realities and nine years of the weld crack discovered when opening it 3.4.1) is shown in Table 3.4.1(Refer to the number of object tanks to Table 3.4.2). In the new law tank of 10,000 kiloliters or more in capacity, nine in 102 cracks occur as a table inside net showed by disregarding. If the accident because of a weld breaking considers 13(7 at six earthquake when driving usually) it in the old law tank, it is necessary to note it in the new law tank though the generation number is less than the old law tank.

*Danger of crack that occurs in bottom weld

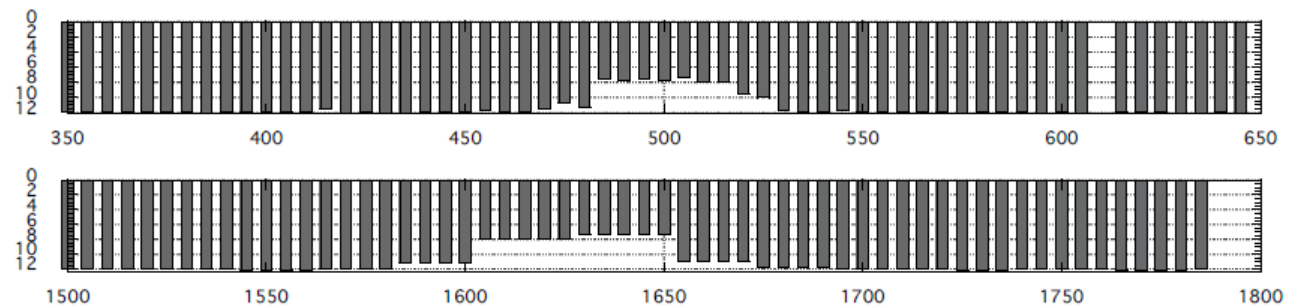
The repair is necessary and indispensable to prevent the outflow accident because the concentration of stress happens to the material with the crack in the crack point when the tensile stress is added in an orthogonal direction in the growth direction, and the crack might progress.

表 3.4.1 開放時に発見された溶接部割れの部位及び件数

溶接継ぎ手種類	法令区分	容量区分	件
側板 × アニュラ板 (内)	旧法タンク	1万キロリットル未満	16
		1万キロリットル以上	18
	新法タンク	1万キロリットル未満	1
		1万キロリットル以上	1
側板 × アニュラ板 (外)	旧法タンク	1万キロリットル未満	1
		1万キロリットル以上	11
	新法タンク	1万キロリットル未満	0
		1万キロリットル以上	1
アニュラ板 × アニュラ板 (内)	旧法タンク	1万キロリットル未満	3
		1万キロリットル以上	16
	新法タンク	1万キロリットル未満	0
		1万キロリットル以上	1
アニュラ板 × アニュラ板 (外)	旧法タンク	1万キロリットル未満	1
		1万キロリットル以上	5
	新法タンク	1万キロリットル未満	0
		1万キロリットル以上	1
アニュラ板 × 底板	旧法タンク	1万キロリットル未満	4
		1万キロリットル以上	22
	新法タンク	1万キロリットル未満	0
		1万キロリットル以上	3
底板 × 底板	旧法タンク	1万キロリットル未満	13
		1万キロリットル以上	55
	新法タンク	1万キロリットル未満	1
		1万キロリットル以上	2

表 3.4.2 調査対象タンク基数

	1 万キロリットル未満	1 万キロリットル以上
旧法タンク	489 基	618 基
新法タンク	14 基	102 基

3.4.2 [Yojumyou] evaluation in weld

The one that the rest can become the factor of breaking, too is enumerated though the crack of the weld is the main factor of breaking, and right or wrong of the [yojumyou] evaluation and the idea to health in the weld are arranged based on distinctiveness in the weld of the tank bottom of a specific outdoor tank reservoir.

(1)Factor of breaking weld (From a past accident case). ・The concentration of stress is generated in the part with initial malfunctions of an over grinder and the defective shape, etc.

・The wound on the back side might progress to the surface because it cannot understand the wound on the back side in the bottom weld in the tank.

・The bottom board might cause coming to the surface because the base causes the uneven settlement, and it connects steel boards by the welding, and a high stress might act on the bottom board in the tank.

(2)Characteristic in weld of tank bottom

・The wound might exist on internal or the back side because it cannot confirm it by welding the tank bottom (From the restriction in the technology) like this though it is confirmed that there are no wounds in internal and the surface (inside, outside both sides) by the radiography when constructing it in high-pressure gas [**] tank etc. (Figure 3.4.1).

・It is possible for an internal wound to come out into the open so that the weld of the tank bottom may receive corrosion, and to become a stress concentration source. ・Because a weld wound of the tank bottom cannot be examined from the outside unlike high-pressure gas [**] tank and piping while driving, the progress degree of the wound cannot be measured.

・The examination of the wound of the surface of the weld and the surface neighborhood is executed about the weld of the tank bottom of a specific outdoor tank reservoir. The wound occurs newly while using it, and if it is considered that the crack of the back side might progress to the surface, it is necessary to examine it regularly though the repair is executed because it is likely to progress when the crack exists in the weld.



図 3.4.1 タンク底部の溶接部欠陥イメージ図

The wound in the weld of the tank bottom is repaired if necessary considering the above-mentioned characteristic when regularly inspecting it, and in a present technology, it is difficult for the weld to evaluate years how many another there is longevity. Health in the weld is thought that it is reasonable to refer to results in a present technology.

(reference)

Weld breaking case in tank bottom generated in January, 2010. It presumes in the one and the office by the low cycle fatigue.

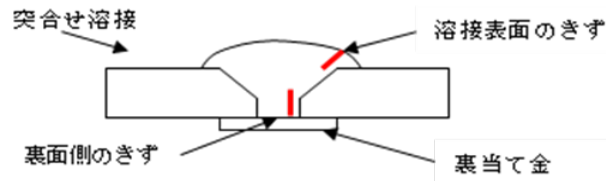
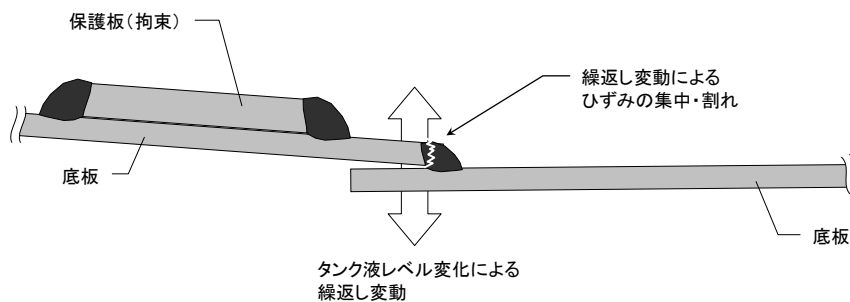
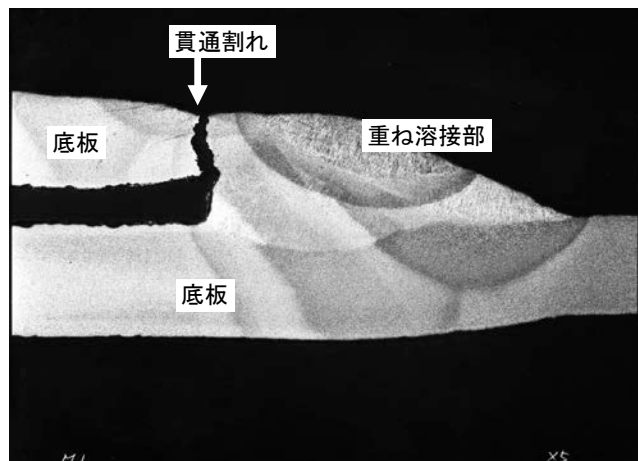

References cited

1) Hazardous Materials Safety Techniques Association: Investigation examination report concerning ideal way of specific outdoor tank reservoir of less than 10,000 kiloliters at cycle of open and March, 1999)

3.5 Outflow accident generation number presumption table 3.5.1 due to 3.5.1 summary corrosion of the impact statement when the inspection cycle is extended is summaries of the result by the continuous board thickness measurement assumption of the penetration presumption numbers of the back corrosion of the one based on the presumption upper bound value at the inside corrosion speed of the penetration presumption numbers the inside corroding about 3.1 and 3.2. The total cardinal number excluded and requested the penetration cardinal number due to inside corrosion from both of the penetration cardinal number due to the back corrosion one with a long penetration presumption year of the overlapping tank.

It is thought that the greater part of tanks were verified because the number of new law tanks of 10,000 kiloliters or more in capacity is 582 as of March 31, 2009 after a peak of 624 of the 1999, and the tank used for the analysis is 617 (Abolition is included).

表 3.5.1 腐食により貫通事故が発生すると推定されるタンク基数

開放までの年数	内面腐食による貫通基数 (累計)	裏面腐食による貫通基数 (累計)	重複しているもの (累計)	合計基数
8 以下	1	3	1	3
～9	5	6	1	10
～10	5	7	1	11
～11	11	9	2	18
～12	15	10	2	23
～13	21	12	3	30
～14	23	14	3	34
～15	29	15	3	41
～16	33	17	4	46

推定結果の留意点

次の点については定量的に評価する技術、データが無い場合、単純な仮定を用いた。これらは推定年を長くする（危険性を過小評価する）仮定であることに留意する必要がある。

- ①板厚が 0 mm となった年数を算定したもの。
- ②内面腐食又は裏面腐食のいずれかのみで算定したものであること（最大内面腐食箇所の裏に裏面腐食があることや最大裏面腐食箇所の内面に内面腐食があることは想定していない。*）。
- ③内面腐食速度の変化割合は平均値の変化割合を用いていること。
- ④裏面腐食速度が経年変化することは考慮していないこと。
- ⑤裏面最大腐食深さは定点測定法による値に対して平均的な係数を乗じた深さとしたこと（実際には、より深いものも考えられる）。
- ⑥この結果は、腐食による貫通孔発生推定であり、溶接部割れや耐震性については考慮していないこと。

*平成 17～21 年度に保安検査を受けた 354 基のタンク中、保安検査時に板厚が最小であった箇所のうち、内面及び裏面の両方に腐食があったものは、アニュラ板 26 基（7.5%）、底板 95 基（27.5%）であり、内面と裏面に同時に腐食が発生することは十分に考えられる。

The new law tank of 10,000 kiloliters or more in capacity with the possibility that board thickness becomes 0mm the present, basic inspection cycle eight even years due to inside corrosion or the back corrosion becomes three in 617 calculations though it is an estimated result that puts a constant assumption condition. If the following is based, the present, basic inspection cycle eight years are expectations of reasonable safety, and it cannot be said that the safety allowance was excessively expected.

- The corrosion rating of the tank bottom must have the possibility of changing greatly constantly.

- Corrosion must progress to the forecast of the part that the corrosion rating grows by the tank bottom difficult, and locally greatly.

- In the finding that lies corroded of the tank, it cannot be necessarily said that it will be accumulated enough, and is necessary to accumulate data concerning the corrosion situation of the bottom when you continuously open the tank.

The evaluation that it became 11, and a dangerous outflow rose up to about four times was obtained in the new law tank of 10,000 kiloliters or more in capacity with the possibility that board thickness becomes 0mm due to inside corrosion or the back corrosion when the fundamental period was

(reference)

The above-mentioned presumption result is based on the assumption etc. shown in the above-mentioned note though an accurate comparison with the tank accident of the reality is difficult, Especially do fundamental period do accident frequency table object tank cardinal number installation passage yr radical age divide new law tank number put calculation to the extent that increase recently capacity tank bottom outflow accident frequency above-mentioned presumption frequency increase accident frequency.



図 3.5.1 底部流出事故の事故発生フロー(図 2.6.2 に表 3.5.1 の結果に対応する過程を記入。図中の数値は容量 1 万キロリットル以上の屋外貯蔵タンクの過去の事故件数。)

It is what based on constant assumption, and it is actually thought to grow more than this from the inclusion also of assumption that lengthens the presumption year (Danger is evaluated small) in that though these evaluations are the one that only "Penetration hole formation due to corrosion" that presumption is possible was assumed. In addition, it is expected that the influence on safety when the cycle is extended grows more than this , considering "Occurrence of the accident because of a weld breaking" that the evaluation is difficult and "Generation of the tank where earthquake resistance cannot be confirmed" (The generation number of accidents grows). The one that corrosion progressed like the half ditch of initial board thickness at a present cycle was presumed though the influence on earthquake resistance was not able to be evaluated quantitatively though it was a reference trial calculation value that the one for which attention was necessary came out.

Because a dangerous outflow rises greatly, it is not suitable to extend the fundamental period if it is considered to become a major catastrophe extremely if a basic now cycle eight years are expectations of reasonable safety, and the dangerous article outflow accident happens from the above-mentioned because of the tank bottom of 10,000 kiloliters or more in capacity by any chance with a present inspection method maintained.

Chapter 4 How at cycle of security inspection that uses continuous board thickness metrology for being

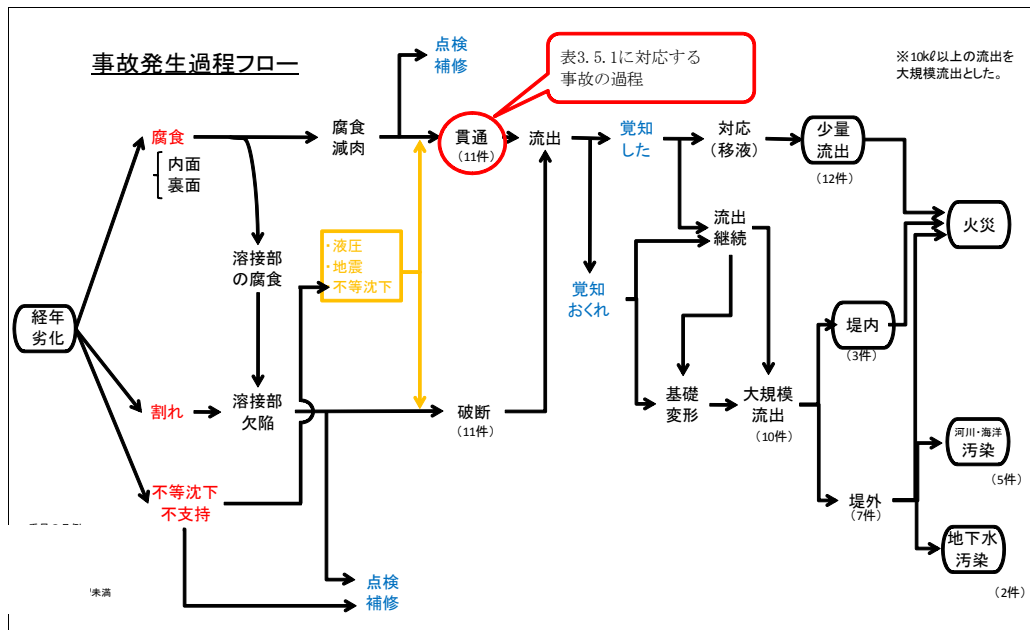
As for the back corrosion of the tank bottom, the tendency management that assumes the value measured (fixed point measurement) by the extraction point not biased to be a central value because all aspects cannot be inspected by the inside corroding and different watching, and is based on historical earnings is done. On the other hand, the maximum value of the detected corrosion depth is different from the actual, maximum corrosion depth because of the fixed point measurement though it is necessary to know a detailed corrosion situation of each tank, especially the maximum corrosion depth to manage safety strictly because of the mind ..the prolongment at the inspection cycle... Then, very detailed corrosion depth can be understood when the continuous board thickness metrology is used is evaluated, and how of the cycle of the security inspection in that case for being is examined.

4.1 Evaluation of continuous board thickness measurement technique

In 3.3, the corrosion depth data of the measurement part when assuming that the [anyura] board and each bottom plate was measured from the continuous board thickness data by the fixed point metrology was extracted, and the relation to the maximum corrosion depth of the continuous board thickness data was analyzed. The result was summarized in Figure 4.1.1 and Table 4.1.1. A red point indicates the value in which the maximum corrosion depth extracted from five kinds of location of measurements that a blue point was imitated the 169th notification for one tank and set is averaged by Figure 4.1.1, and indicates the value in which the maximum corrosion depth that imitates the 56th notification for one tank and extracts it from five kinds of location of measurements is averaged.



図 4.1.1 定点測定結果と連続板厚測定結果の相関分析結果

表 4.1.1 定点測定法による裏面腐食深さに対する連続板厚測定法による最大裏面腐食深さの平均的な比率 (表 3.2.1 再掲)

	56号通知の定点測定法による裏面腐食深さに対する比率	169号通知の定点測定法による裏面腐食深さに対する比率
アニュラ板の最大裏面腐食深さ	2.90	1.59
底板の最大裏面腐食深さ	3.77	1.95

The example of analyzing the tank bottom board of about 82m in inside diameter is shown in Figure 4.1.2 and Table 4.1.2 so that the continuous board thickness metrology may evaluate whether to obtain data in detail of which extent compared with the fixed point metrology. In a left graph of Figure 4.1.2, a histogram of board thickness that assumes the fixed point metrology by the 56th notification from the continuous board thickness data and extracts it and right graph is histogram of the board thickness of the continuous board thickness measurement data (The spindle at the left of the graph is a measurement point, a horizontal axis is board thickness, and a right spindle is a ratio of the measurement point to the entire measurement point).

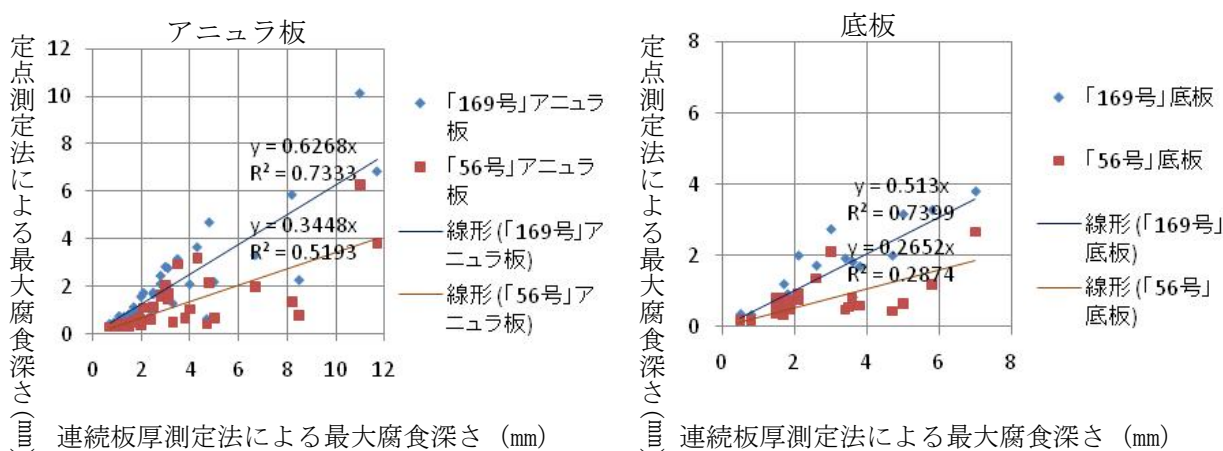

図 4.1.2 定点測定法を想定して抽出データと連続板厚データの板厚ヒストグラム

表 4.1.2 定点測定法を想定して抽出データと連続板厚データの測定点数と板厚最小値

	測定点数	測定される最小板厚(mm)
定点測定法抽出	451	11.1
連続板厚測定法	1億8400万	8.2

Precision's in which the minute sheath maximum corrosion depth of the measurement of the corrosion depth is measured compared with the case to use the fixed point metrology improving becomes clear, and the uncertainty concerning corrosion decreases among the deterioration factors of the tank when the continuous board thickness metrology is used from the above-mentioned result. Therefore, the inspection cycle of the tank is extended noting the following points when the management of the back corrosion becomes possible in detail by using the continuous board thickness metrology.

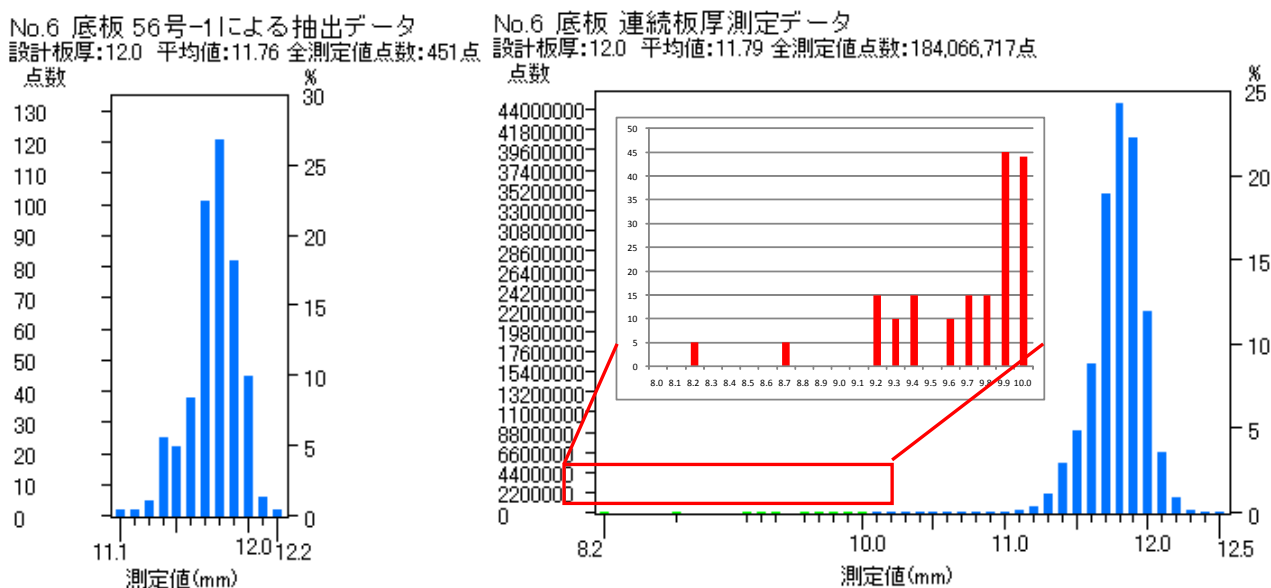
? The weld of the tank bottom cannot be understood while using it even if support trouble, the back, and an inside wound of the base exist. It is difficult to do the fixed quantity evaluation how it is deteriorated to the next opening. It is necessary to inspect the mortgage of health in the weld of these parts for every a constant period.

? As for the corrosion rating, it is necessary to expect the room of the corrosion depth from might the passing age acceleration of not constancy but the corrosion rating to the next opening for constant safety.

? If the inspection cycle is extended it is necessary to secure the check chance due to deterioration in attached equipment of the shroud and the drain piping, etc. for the prevention of accidents, further consideration is necessary for the deterioration factor measures managed by the independent security management.

4.2 It is needless to say that the matter that leads to the increase of a dangerous outflow from the tank should note that it is necessary to exclude it when the security inspection cycle is examined about the tank of 10,000 kiloliters or more in capacity where a large amount of dangerous articles such as basic idea oil of the security inspection of the outdoor tank reservoir as of method 4.2.1 of deciding the time of the security inspection that uses the continuous board thickness metrology are stored. For this, the dangerous article outflow accident has not been caused until the following tank is opened by understanding the current state of the safety of the tank (board thickness of the bottom and wound in the weld, etc.) when opening regularly done is inspected, and doing a necessary repair. The tank is opened by the safety of the tank 10 years of eight years or 13 every years, health (It is general that only the inside surface side is inspected in the fixed point) in the inside corrosion depth, the back corrosion depth (Being measured in the fixed point is general) of the tank bottom, and the weld is confirmed, and it is also true that there is an inspection item that cannot help being inspected by the extraction under the present situation. On the other hand, the room for the safety of the change of the situation of non-area to be examined and the corrosion rating etc. is expected, and Table 2.6 in the [anyura] board of the tank bottom board thickness. It corrodes from the minimum thickness (It is 12mm in the tank of 10,000 kiloliters or more in capacity)

that hangs to 17 of the Articles 4 of notification in minimum thickness corresponding to the division of the thickness of the the lower of the shroud shown in two and the bottom plate and it has been managed by more than the value in which 3mm in the furnace is decreased it.

4.2.2 Idea of security inspection that uses continuous board thickness metrology at cycle
The inspection accuracy will rise to the extent that non-area to be examined that lies the back corrosion is lost if the back corrosion depth of the tank bottom is measured in detail by the continuous board thickness metrology. On the other hand..weld..healthy..inspection accuracy..change..corrosion rating..pass..age..change..width..the..factor..finding..enough..accumulate..safety..secure ..security..inspection..cycle..extension..think..safe..room..constant..expect.How to expect room for safety is possible for the change and the corrosion rating of the management board thickness

(= design board thickness ? must corrode) to consider the safety surcharge. In that case, it is computable in the following expression in a next year of open allowance)

When how the corrosion rating changed of the past was examined (2.4 and 2.5 references), it is a difficult to say current state that an enough finding has been accumulated to be clarified of greatly in each shut down inspection the back, the inside, and the corrosion rating different, and to set the corrosion rating that considers the room for safety objectively and quantitatively. Moreover, there is no reasonable reason to change a present idea ("The earthquake of about six in the seismic intensity is stopped in the elastic deformation" "In addition, it is not at least caused the outflow though the transformation remains for the severe earthquake. " and) now about the management board thickness, and the basis of the tank is a membrane structure. The uncertainty is large while there is no room in strength for the transformation that disarranges the assumed dynamic balance. the outside power condition like the accumulation degree etc. of tiredness by the support situation and the repetition load of the bottom board and the base that should be consideredBecause reasonable safety is expected when these are based, it is suitable not to make the management board thickness the object of the cycle when the tank where it sees from following a present idea and the corrosion rating and the erosive environment is defective is examined this time extension.

Next, even if it uses the continuous board thickness metrology, the new law tank should confirm the weld inspection accuracy from no improvement for every a constant period about health in the weld among the security inspection items though reliability in the weld is high because the board thickness of the parent metal is thick etc. Moreover, to confirm corrosion progresses the passing age constantly according to results, the corrosion rating should set the upper bound year about the time of the inspection.

Above..idea..based on..open..continuous..board thickness..metrology..tank..bottom..corrosion..situation..measure..back..corrosion..speed..constant..fulfill certain conditions..coating..construct..causticity..provide..contents..inside..corrosion..speed..very..small..requirement..fill..tank..security..inspection..cycle..constant..years..extend..enable..propose..following clause..propose..cycle..calculation..method..describe.

4.2.3 Calculation method of security inspection cycle when continuous board thickness metrology was used

(1)Method of calculating cycle

Because the tank maintains the healthy condition until the tank will be opened from the viewpoint of the dangerous article outflow prevention next time, this investigation study committee is the following [a]. ..twining.. [o]. In meeting the hanging [ni] requirement, the period until the next inspecting. It proposes to make it to the hanging [ni] period.

[A]. Board thickness must be measured for the tank bottom by the continuous board thickness metrology.

[I]. The corrosion rating of the tank bottom when opening is inspected must be small. (Both of the corrosion ratings from an inspection the last based on data by the continuous board thickness metrology must get used, and be 0.2mm or less of the bottom plate and [anyura] of the object tank/year.)[U]. The coating must be constructed under appropriate management, and the inside corrosion prevention function must be maintained. However, it is a tank where the coating is not constructed, and it is not this according to results that the causticity of contents is remarkably low as for the one that clearly, and the erosive environment like contents and the moisture management (Limit it to the one of the fixed roof form), etc. is changeless. [E]. There must not be change construction of the base etc. after it is measured by the continuous board thickness metrology. [O]. Do not let calefactory be stored to dangerous articles. .The bottom plate and [anyura] forecast the corrosion depth in the future for the period until the next inspecting by getting used, and using the maximum corrosion rating requested from the result of a measurement of the continuous board thickness metrology etc. The

minimum board thickness part after it repairs of each makes the corrosion thinning [shinai] years a period until the next inspecting from the minimum thickness that hangs to 17 of the Articles 4 of notification exceeding 3mm. However, when a period concerned exceeds 15 years, 15 years are made a period until the next opening.

(2)Corrosion rating

The corrosion rating divides at intervals of the shut down inspection and requests the difference of the corrosion depth while it opens last time and it opens it this time. When the continuous board thickness data by the ultrasonic method requests the back corrosion speed when there is an amount twice, necessary data is shown in Table 4.2.1.

表 4.2.1 連続板厚データから裏面腐食速度を算出する必要データ

腐食速度を求めるためのデータ	
①今回開放時の連続板厚データ	裏面腐食深さが大きかった箇所の板厚データを抽出 (※1)
②前回開放時の連続板厚データ	①で抽出された箇所の座標を求め当該座標の周囲φ120mmの板厚データを抽出 (※2)
③腐食速度算出に使用する腐食深さ	①で抽出された箇所の板厚と②で抽出されたφ120mmのうちの最小板厚 (※3)との差を腐食深さとする。
④腐食速度算出に使用する年数	前回と今回開放のインターバル (※4)

- 1: The extraction method of ? extracts two or more (big high rank of the one ten places of the corrosion depth and parts of 1.5mm or more in the corrosion depth) parts (The size of one place is assumed to be φ120mm) where the back corrosion depth was large.

- 2: The performance of the weighing device is ±30mm the positional detection accuracy on 900mm the test piece length ..monotonous.., and is thought for reproducibility at the corrosion position to have to expect about the twice the positional detection accuracy of the device , considering the condition of the site like undulation and the length etc. of the traverse line of the board in the site operation. That is, it is necessary to think about φ120mm to search out the part where corrosion was intense from the last measuring data surely this time. Reference?The example when surroundings φ120mm in the intense back corrosion part requested from the continuous board thickness data from seven are considered is shown.

- 3: When the board thickness data of the part extracted by ? is not obtained by the last no display part (less than 60mm×60mm) etc. , the board thickness of a part concerned is assumed to be initial board thickness that considers the allowance that lies board thickness. Moreover, when the measuring method when opening it last time is a fixed

point metrology, and the detailed measurement data of 30mm pitch is obtained in a part concerned, the detailed concerned, measurement data can be used.

- 4: Years of last time and opening this time of the interval are the last date inspected and this date inspected.

?Each corrosion rating of part to which [niyori] was extracted?It requests by \div ? (mm/year), and the maximum value in that is assumed to be the back corrosion speed of the tank to calculate the time of open of next time. When the back corrosion speed is requested, thinning by the factor that doesn't depend on corrosion it doesn't treat the clear one as corrosion depth including cutting down by strike [kizu] and the grinder etc. Does the inside corrosion speed extract big high rank of the one ten places of the corrosion depth and parts of 1.5mm or more in the corrosion depth of the inside corrosion part of opening this time, assume the difference (When the corrosion depth when inspecting it last time is an uncertainty, it is assumed 0) with the corrosion depth when inspecting it last time of each part to be inside corrosion depth for the corrosion speed calculation, and : the maximum value in that?[De] crack is requested.

After the corrosion rating is requested by the above-mentioned method, the maximum corrosion rating is requested by the following method.

- The maximum value at the back corrosion speed calculated from result of a measurement of continuous board thickness metrology when appropriate coating is constructed to tank interior

- When the coating is not constructed to the tank interior

Either of of the maximum values of corrosion rating of the maximum value at calculated the back corrosion speed and inside corrosion part (corrosion rating that considers both when the back corrosion exists in part concerned) value that ..largeness.. becomes it from result of a measurement of continuous board thickness metrology

(3)Continuous board thickness metrology

The continuous board thickness metrology is assumed that the bottom board almost measures everything following 30mm intervals considering the resolution of the weighing device operated now. Moreover, the part where the measurement with the device by the continuous board thickness metrology is impossible is generated in an actual tank so that the obstacle etc. may exist. It is assumed that it measures it by the manual operation as a rule at intervals of 30milli or less in such a part. However, the measurement is extremely difficult, and because the area is limited, the measurement by the manual operation is not needed about the following part.

? Defective part of surrounding ? measurements of protective plate and protective plate

(Investigate the cause of the loss, and execute the remeasuring by the continuous board thickness metrology . For the area of less than 60mm×60mm in the measurement loss part after the cause is confirmed).

*The measurement by the continuous board thickness metrology has already been done. The total of the area within the range of the fixed point measurement (The above-mentioned [ni] excludes the lying one) in the equipment concerned neighborhood considers the one that the fixed point measurement is done in the attached equipment neighborhood such as the receiving payment piping and the vicinity of the water pulling out for the measurement by the continuous board thickness metrology to have been done only as for the one that is 1% or less of the entire bottom board. When the inspection cycle is extended, the board thickness when opening it last time is considered that there was no back corrosion, and assumed to be initial board thickness by using the continuous board thickness metrology because it is not possible to compare it with the continuous board thickness data when opening it this time when the data when opening it last time is a fixed point metrology. Initial board thickness considers the allowance that lies the board thickness of the board of the part extracted from the continuous board thickness data concerned.

4.3Idea of calculation method of cycle

4.3.1 Upper bound value at the back corrosion speed

In the tank etc. where the design board thickness is thicker than the minimum thickness provided in 17 of the Articles 4 of notification, it is thought that there is the one that the remainder board thickness to the management board thickness is large even if the corrosion rating is large, and it becomes possible to extend the security inspection cycle for eight years in such the one though remarkable corrosion has been received.

For this case, because the board thickness at the time of a little opening next time even if comparatively changing changes greatly, the back corrosion speed might not be able to mortgage safety.

Moreover, there is a case where an abnormal corrosion rating is measured on the back of the bottom of the new law tank like the description by 2.5.2, too and it is necessary to set the upper bound value to confirm progress on the condition the back corrosion's being usually thought about the tank where the inspection cycle is extended.

It is suitable to refer to an average value to confirm progress on the condition corrode being usually thought by the value at the back corrosion speed.

The mean value at the back corrosion speed based on the fixed point metrology was

0.051mm in the bottom plate/year (2.5 references) of [anyura] board 0.058mm/year.

It is thought that this extent is an average to an actual back corrosion speed of the tank by each becoming 0.19mm/year during 0.17mm/year if the ratio of the maximum both corrosion depth ([anyura] board 2.9 and bottom plate 3.8 from Table 4.1.1) to the back corrosion depth obtained from the analysis of the corrosion depth by the fixed point metrology and the corrosion depth by the continuous board thickness metrology for these is put. The upper bound at the back corrosion speed was assumed to be 0.2mm/year considering the accuracy of the analysis.

4.3.2 Management board thickness value

The hydraulic pressure, a residual stress by the welding, a local subsidence of the base, the bend stress by the uneven settlement, and power of coming to the surface due to the earthquake, etc. act on the bottom board. Minimum thickness to a present [anyura] board and the bottom plate assumes to corrode because of the one provided aiming at installing on the elastic deformation for the seismic ground motion of about six in the seismic intensity and is 1 including 3mm.)Corroding because extending the inspection of open cycle increases the uncertainty to the corrosion depth and changing at the same time as the furnace's extending at the cycle might greatly decrease safety, and it is not suitable to change the management board thickness (Minimum thickness ? must corrode).

4.3.3 The back corrosion

As for the one large the back corrosion depth having been reported, Figure 4.3.1 is seeing of the back corrosion speed (one by the fixed point metrology) at the time of each opening of an individual tank (Figure 2.5.4 and Figure 2.5.5 re-[*]) among the new law tanks. It is difficult to understand the corrosion rating of each times of open has changed from this figure, and to obtain the upper bound of the change ratio objectively. The change, the base of deterioration in the back anti-corrosion measures, deterioration in the rain water going into it preventive measure, and the storing temperature, and changes in the contact situation with the bottom board, etc. are actually thought as a factor that the back corrosion speed changes.

On the other hand, the back corrosion speed requested from this figure by the fixed point metrology in the normal temperature tank has been installed within the range of 0.4mm or less/year. It is assumed that it is 0.4mm or less/year even if the back corrosion speed changes when the object tank of the extension of the inspection cycle examined this time is made a normal temperature tank whose upper bound value at the back corrosion speed measured by the continuous board thickness metrology is 0.2mm/year. Even if the situation with low possibility that the back corrosion of 0.4mm/year

continues for 15 years that are the upper bounds for the extension period is developed, the back corrosion depth of 15 years is 6mm. Even if the situation with lower possibility that such a situation occurs in the minimum board thickness part in the tank where there is board thickness near the minimum value 9mm of the management by objectives board thickness in the bottom plate and the back corrosion speed till then is low is assumed, the remaining board thickness of 3mm or more can be secured. The situation is assumed according to the trial calculation ..low.. result of the probabilistic assessment of cycle fatigue fracture of the local corrosion part (Table 3.4.1) very the possibility low to begin with though safety in this board thickness when progressing corrosion is to ditch it cannot be confirmed. And, you may think that it can secure safety within the reasonable range because it remarkably assumes the tough going, that the large-scale earthquake occurs in the end at the cycle of open.

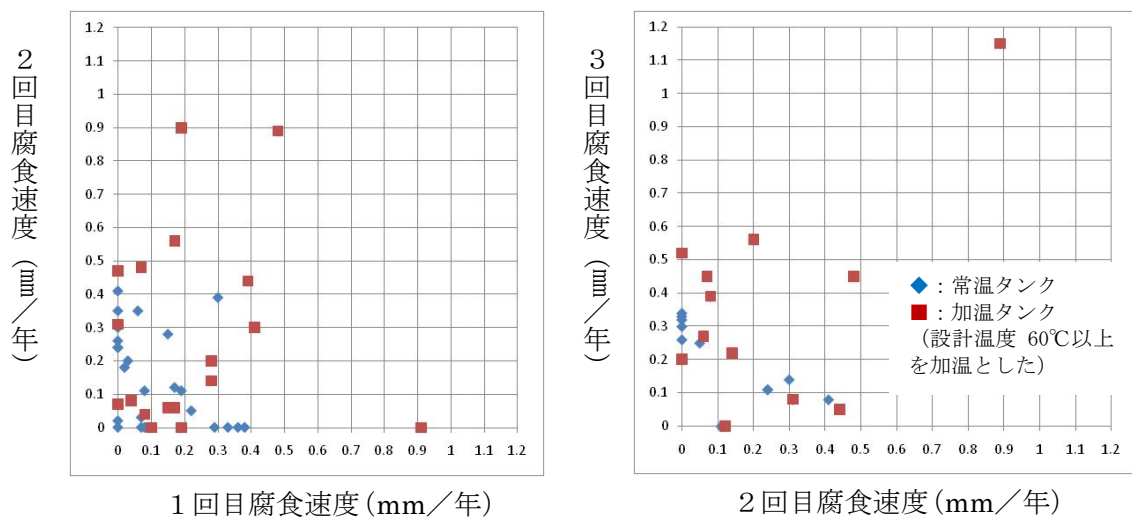

(attention)It is not the one to show the entire tendency because the one that the board was substituted neither the one nor the corrosion depth's with small corrosion depth being measured is not included.

図 4.3.1 1回目開放時の裏面腐食速度と2回目開放時の裏面腐食速度(左)及び2回目開放時の裏面腐食速度と3回目開放時の裏面腐食速度(右)

4.3.4 Inside corrosion speed.

As for the one large the inside corrosion depth having been reported, Figure 4.3.2 is seeing of the inside corrosion speed at the time of each opening of an individual tank (Figure 2.4.5 and Figure 2.4.6 re-[*]) among the new law tanks. It is not included that the coating was constructed when opening is inspected about the clear one because

there is no compared meanings. The change of each times of open of the inside corrosion speed is intense from this figure, and the tank that can be applied when the corrosion rating when opening it last time will open it next time is limited. It is at the following either that is thought that the inside corrosion speed until the next opening can presume in accuracy good [ku] the idea that inside corrosion hardly progresses.

[A]. When the inside corrosion prevention function of the coating is maintained

[I]. It is a tank where the coating that stores contents with a very low causticity is not constructed, and when the factor that influences the inside corrosion environment by the oil temperature and the moisture management, etc. is changeless

It is clarified that the coating constructed by the coating indicator doesn't flake off easily though big inside corrosion of the corrosion rating might be caused in the tank where the coating was constructed when the coating flakes off. [A]. It is suitable to drink and to confirm the coating is maintained excellently when it is assumed that it was constructed by the coating indicator, and the performance more than the equal to it is possessed, and opens the tank. [I]. Assuming that it is a tank without the coating, and the inside corrosion speed will be 0.1mm or less in 2 in Kon opening or more/year soon drinking is suitable.

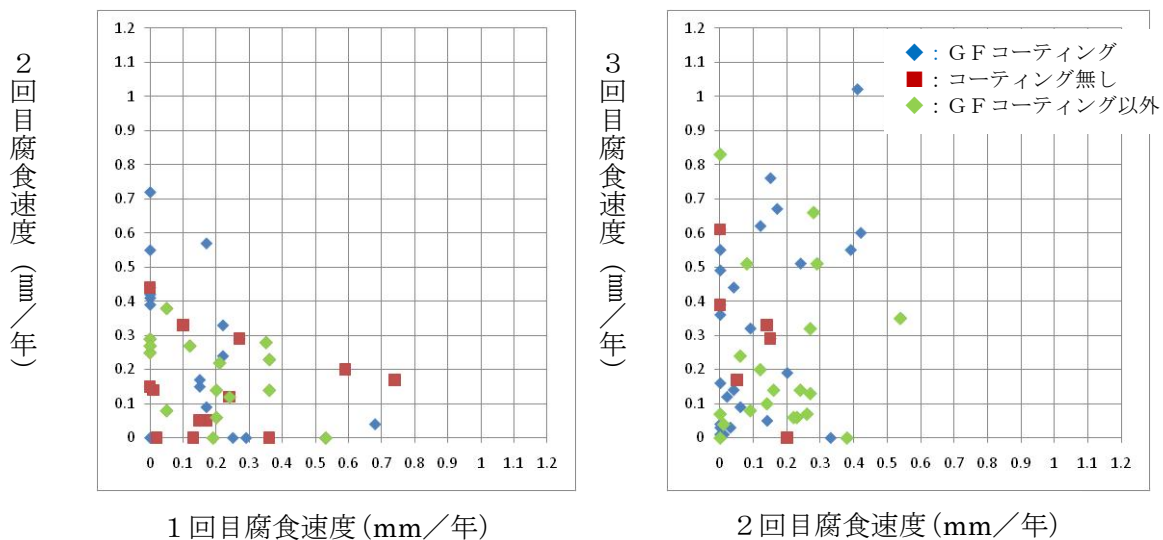

(attention)It is not the one to show the entire tendency because the one that the board was substituted neither the one nor the corrosion depth's with small corrosion depth being measured is not included. Inside thinning that doesn't depend on corrosion like

図 4.3.2 1 回目開放時の内面腐食速度と 2 回目開放時の内面腐食速度 (左) 及び 2 回目開放時の内面腐食速度と 3 回目開放時の内面腐食速度 (右)

[I]. It considered it drinking as follows. The corrosion rating is even if it is managed in the tank such as petrochemicals so that the causticity of contents is low, and the corrosion element should not mix, and there is no coating and there is the extremely small one as results. Table 4.3.2 is a summary of the inside corrosion speed when opening it in contents, the capacity of the tank where the coating has never been done in the past, and the past. The inside corrosion speed was requested from the maximum, inside corrosion depth when the inside corrosion depth of less than meat vigor standard when opening it last time and opening it this time, and thinning caused by the strike wound is included in the inside corrosion depth. A bigger corrosion rating of the [anyura] board or the bottom plates was described.

Something thought that the causticity such as crude oil is high is seen in Table 4.3.2, and the inside corrosion speed is seen with the petrochemical etc. while it is and the extremely low one is seen continuously. For instance, a yellow net showed the one that the corrosion rating of 0.1mm or less/year continued two times by disregarding. It can be expected that it is extremely low about such a tank the change in the change in contents, changes in the storing temperature, and the moisture management conditions etc. as the corrosion rating until the next opening continues. Whats shown in orange soon will be the corrosion ratings of 0.1mm or less/year the corrosion rating of 2 times in Kon, and be increases of the corrosion ratings to the 3rd times more than 0.1mm/year. It is a tank of the floatage roof type on, and the moisture management condition is bad of three cases. The second is a warming tank, and the erosive environment is severe. The inspection cycle extension excludes the floatage roof type tank and the warming tank and these two can be excluded. The third case can secure safety because it has fallen below the upper bound value 0.2mm of the speed of the corrosion of results of the tank where and 0.15mm/decision method of this cycle are assumed to be applicable/year though deteriorated the corrosion rating.

表 4.3.2 腐食速度が低いコーティングがないタンクの諸元

内容物	加温/常温	容量(kℓ)	1回目腐食速度	2回目腐食速度	3回目腐食速度	部位
原油	加温	31,197	0.01	0.14	0.33	アニュラ
ナフサ	常温	40,000	0.13	0	0.39	底板
原油	常温	98,290	0.15	0.05	0.29	底板
灯油	常温	24,920	0.27	0.29		底板
ナフサ	不明	101,706	0.74	0.17		底板
ナフサ	常温	38,955	0.02	0	0.61	底板
ナフサ	常温	101,760	0.59	0.2	0	底板
重油	加温	29,750	0.1	0.33		底板
重油	加温	20,435	0.36	0		底板
ナフサ	常温	40,000	0.13	0	0.39	底板
原油	常温	102,700	0.24	0.12		底板
原油	常温	103,000	0	0.44		底板
A重油	常温	19,848	0.43	0	0.09	底板
A重油	常温	29,750	0.19	0.05	0.17	底板
重油	加温	20,000	0	0.14	0.02	底板
重油	常温	11,106	0.14	0.04		底板
重油	加温	30,000	0.02	0	0.22	底板
重油	加温	30,000	0	0.11	0.06	底板
灯油	常温	26,995	0.19	0.13		底板
ベンゼン	常温	25,514	0.12	0.11		底板
重油	加温	12,360	0.18	0.11	0.02	底板
重油	加温	43,000	0.3	0	0	底板
メチルアルコール	常温	23,508	0	0	0.08	アニュラ
メチルアルコール	常温	23,508	0.03	0	0.15	アニュラ
メチルアルコール	常温	23,508	0	0	0	アニュラ
メチルアルコール	常温	23,508	0.03	0		アニュラ
二塩化エタン	常温	17,100	0	0.17		アニュラ
メタノール	常温	17,100	0	0.17		アニュラ
キシレン	常温	14,047	0.11	0.02		アニュラ
C重油	加温	14,942	0	0.18	0.03	底板

4.3.5 Upper bound year of inspection cycle

It is necessary to inspect health in the weld every certain period and to provide for the upper bound of the cycle to a large-scale accident when changing greatly by the corrosion rating though it is comparatively low for two purposes when the security inspection cycle is extended it is possible to extend. the possibility ..doing a necessary repair.. make it not arrive

In 3.5, the crack of nine welds is found in the tank of 102 new laws of 10,000 kiloliters or more in capacity, and it is understood that a weld inspection is necessary every certain period. Moreover, the outflow accident that originates in the crack in the new law tank doesn't happen in the tank from 1,000 kiloliters in capacity to less than 10,000 kiloliters

though the crack is found by two in 14 though the population parameter is few.

Old law tank this crack find past..weld..break..accident..generate..new law..tank..use..weld in a butt joint..old law..tank..use..fillet welding..weld..reliability..high..general..say..old law..tank..board thickness..thick..new law..tank..weld..thickness..old law..tank..thick..become..capacity..tank..tank..height. Capacity..tank..height..hardly..change..hydraulic pressure..stress fluctuation..big..differ..provide..capacity..small..tank..one..change..frequency..high..assu me..based on..new law..tank..corrosion..progress..slow..one..weld..inspection..interval..capacity..new law..tank..as well as..upper bound..safety..large..ruin..think.

Moreover, the back corrosion progresses abnormally by some causes like deterioration in the back anti-corrosion measures and deterioration in the rain water going into it preventive measure, etc. It is as describing by 4.3.3 to be able to secure safety by assuming 15 years to be an upper bound even if the situation with very low possibility that the corrosion rating abnormally grows than the past back corrosion speed used to calculate at the cycle is generated by any chance within the reasonable range. It is suitable to set the upper bound year of 15 years from the above-mentioned.

4.3.6 Corrosion environment

The size and the change degree of the corrosion rating grow like being clarified when the back corrosion speed and the inside corrosion speed are examined in the warming tank. The trouble of the coating thought to originate in this is reported (for instance, 5.5.2(3)). Moreover, the temperature in the management temperature and the vicinity of the heater of contents : though sets up in the tank of the heater coil when it hits the warming of the tank though was clarified of there is danger of showing a big corrosion rating in the warming tank like this ..the idea of differing, and becoming a high temperature partially around the heater.. ..(... The one that calefactory is stored is assumed to be exclusion from the object of the extension of the cycle based on the forecast of the corrosion rating in this examination because neither the finding nor data that the corrosion rating can be suppressed small have been accumulated if lecturing on some measures.

Moreover, it might influence the corrosion rating when there are a change in the storing temperature and a change in the back anti-corrosion measures etc. , and when being open it next time, it is corrosion depth that neither the storage condition nor the structure that influences the occurrence of corrosion from will not greatly change Kon's corrosion rating soon important change about accuracy [yoku] [o] fixed [surutameni].

4.3.4 [i]. It corresponds about the one that [ni] corresponds in the storage condition from important the causticity of contents changeless from which the change in the change (Change in the amount of the corrosion element in crude oil) in contents and the moisture management conditions also changes the corrosion rating.

4.3.7 Operation and maintenance in the entire tank

In the measures for security necessary to extend a present security inspection cycle, measures to the accident factors other than corrosion is assumed to be a requirement (Refer to Table 2.1.1). To secure the safety of the tank, it should be assumed the condition also for the requirement that lies structural healthy to extend the cycle to say nothing of health in the weld in addition to the matter concerning corrosion though the matter concerning corrosion was mainly arranged in the ideal way at the inspection cycle examined in 4.2.3. In a word, it should be assumed to the one of the measures in the present system for security that hangs next the requirement in the decision method of the cycle proposes this time.

?It causes a past accident case, and the residual stress by coming to the surface and the welding of the transformation of the tank bottom by a local subsidence of the tank foundation and the bottom board from the base etc. want to suppress the fear of the accident to low, and should provide for the requirement for repairing methods of the tank etc. for these. Is a regulated content a reference?This content is 3 that is the summary because of making such as the tank manufacturers a general standard of repairing methods of the outdoor storage tank as shown in six.)

?The uneven settlement of the base provides for this requirement because it comes to become a factor that an excessive stress is generated in the corner corner part of the tank and to increase the fear of the accident of influencing harmfully to the structure of the tank.

?Tank..use..ground..bearing

capacity..shortage..pass..age..tank..subside..tank..structure..adverse

effect..reach..accident..fear..increase..have..become..this..requirement..provide.

?The outflow accident from the tank also has the case generated by the aged deterioration of attached equipment of the shroud and the drain piping, etc.It is not provided to mortgage health by a public inspection as described by 2.6.5 about a shroud, a roof, and attached equipment, and the operation and maintenance has been entrusted to them by the owner etc. of the tank. It provides for this requirement to suppress the fear of the outflow accident of the tank to low because the approach situation of independent security by the office etc. is also indispensable.

4.3.8 Proposed object tank of cycle

In the examination of the calculation method of the cycle described above, it paid attention to the exquisite clarification of the situation of the back corrosion by the continuous board thickness metrology compared with a past inspection method, and the matter concerning board thickness was examined. It is possible to extend to the preceding clause at the cycle if board thickness can be managed by the description method because the adequate security is secured about factors other than corrosion in the generation factor of the accident arranged by 2.6.3 if it is the first stage standard tank of the new law tank and the old law with safety maintained. On the other hand, if a present cycle is extended, an enough finding has not been accumulated about factors other than corrosion in the generation factor of the accident arranged by 2.6.3 now though the examination is necessary though an old law new standard tank is assumed to be a present basic cycle seven years (The one that the measures for security is taken is 8?10). A new law tank and the first standard tank of the old law are made a preceding clause from the above-mentioned with the application object of the described cycle extension at this study committee.

4.3.9 Summary

This chapter examined the ideal way at the security inspection cycle based on the evaluation of the continuous board thickness metrology. As a result, it proposes the decision method of the cycle as shown in the following table in consideration of the ensuring safety to the secular distortion etc. of the corrosion rating on the period of the inspection of the weld that cannot be inspected by the continuous board thickness metrology, the inside of the tank bottom, and the back.

表 4.4.1 連続板厚測定法を活用した保安検査周期の決定方法

項目		開放周期延長の要件	
実施する検査		連続板厚測定法を実施（機械測定が難しい部位については、手動で詳細測定を実施）。	
次回検査までの期間の求め方		$\text{次回検査までの年} = (\text{現時点板厚} - \text{管理板厚}^*) \div (\text{腐食速度})$ *管理板厚：告示第4条の17の最小厚さから腐食しろ3mmを減じた値	
腐食速度の求め方	底板	○コーティングを施工したタンクの場合	○コーティングを施工していないタンクの場合
	アニューラ板	連続板厚測定法の測定結果から算出された裏面腐食速度の最大値	連続板厚測定法の測定結果から算出された裏面腐食速度の最大値と内面腐食箇所の腐食速度の最大値（当該箇所に裏面腐食が存在する場合は両方を考慮した腐食速度）のいずれか大なる値
期間の上限		15年	

内面腐食に関する事項	底板	○コーティングを施工したタンクの場合 コーティング指針に基づき施工されたコーティング、若しくはそれと同等程度の性能を有しているもので、内面腐食防止効果が維持されているもの。	○コーティングを施工していないタンクの場合 ・腐食性の非常に低い内容物を貯蔵している（直近2回の開放において内面腐食速度が0.1mm/年以下であること）。 ・水分管理（固定屋根形式に限る。）が適切になされ、腐食環境に変化がないこと。
	アニュラ板		
裏面腐食に関する事項	底板	連続板厚測定法による測定データに基づく、前回検査から今回開放までの間の腐食速度が0.2mm/年以下であること。	
	アニュラ板		
腐食環境に関する事項		危険物が加温貯蔵されていないこと。	
		腐食の発生に著しい影響を及ぼす貯蔵条件、構造の変更を行わないこと。	
タンク全体の維持管理		タンクに構造上の影響を与えるおそれのある補修又は変形がないこと。	
		著しい不等沈下がなくないこと。	
		地盤が十分な支持力を有するとともに沈下に対し十分な安全性を有していること。	
		特定屋外貯蔵タンクの維持管理体制が適切であること。	

4.3.10 Promotion of main security

It is extremely important not to increase a dangerous occurrence of the outflow accident even if the security inspection cycle is extended as described by 4.2.1. Therefore, when the security inspection cycle is extended, it is necessary to note the following matter especially.

?Settling on the check standard to prevent the accident that originates in the aged deterioration of attached equipment of the shroud and the drain piping, etc. as shown in above-mentioned (4.3.7?) and executing it appropriately are important.

?The realities of the corrosion of the bottom board of the tank cannot necessarily be understood enough. It is important to do the realities analysis and the cause investigation of corrosion, and to share a result concerned about the board that corrosion is intense as 2.4.1 and as many as 2.5.2 were described to secure the safety of the tank when repairing.

It is extremely important to continue the examination of the requirement for the extension of the ideal way of the security inspection and the cycle by accumulating data promoting the approach of such independent security.

References cited

- 1)Oil industrial complex zone disaster prevention measures Technical Assistance Committee: Technological standard (idea) December, report and 1976 concerning tank and base
- 2)The Ministry of Public Management, Home Affairs, Posts and Telecommunications

Fire and Disaster Management Agency: March, investigation examination report and 2003 concerning safety estimate of outdoor storage tank

3)The Japan Machinery Federation and Japan Society of Industrial Machinery Manufacturers: Investigation research report and 1988 concerning repair manual making of dangerous article storage tank

Chapter 5 The life of inside protection coating

An inside coating is one of the requirements as the measures for security for 13 years the longest cycle of the security inspection of the outdoor tank reservoir where dangerous articles of the liquid of 10,000 kiloliters or more in capacity are stored now. About the life of this inside coating paint film, data like results etc. was accumulated, and it came to examine whether the life of the coating paint film was able to be extended without decreasing safety though it was used exceeding this years in recent years assumed to be 20 years ("Coating indicator": fire fighting [abuna] No.74 on September 1, 1994) and was healthy. Therefore, the repair history data of the temperature inclination soaking examination, the site investigation, and the coating paint film was collected, analyzed, and the life was reviewed.

The examination followed the glass flakes coating (Hereafter, it is said, "GF coating"). It is because the GF coating is most as the coating given as the realities in the new law tank though the GF coating or the fiberglass-reinforced plastic lining is a requirement (2 of two of the ministerial ordinance of Article 62 concerning the restriction of dangerous articles) in the new law tank of the examination object in this for the cycle extension. When a past GF coating is examined, "Bisphenol system vinyl ester resin" is generally used from the use of "Bisphenol system vinyl ester resin" instead of this term in this report now though the term "[Epibisu] system vinyl ester resin" is used.

5.1. 2,001 fiscal year? Examination 1 done in 14 fiscal year) 2) 3)

The examination of the life of the coating paint film was done by the investigation of the deterioration situation of the inside coating paint film, the collecting data in a real tank, and the experiment. It is 2 to be arranged to the infiltration of moisture, the swelling by the solvent element, and the swelling by the acid element and the resolution deterioration, and the swelling the degradation phenomenon that has been actually actualized, and to influence a lot as this cause as the deterioration factor of the paint film thought to be a moisture element.)Six kinds of examinations (steam permeability measurement, temperature inclination soaking examination, solvent soaking examination, acid liquid soaking examination, and solvent + acid liquid soaking examination (thin acetic acid/BTX solvent) and solvent + acid liquid soaking examination (acetic acid/benzene)) are done about the evaluation of the durability of the inside coating paint film. 3 to obtain conclusion "It is also possible to verify the performance between long terms or more by accumulating the results data of the durability of the coating with a real tank by examining the temperature inclination soaking to presume the durability limit of paints (40°C/20°C), applying to the working

curve that makes days until generating the swelling an expression, and calculating the service life when it is possible to correspond and it is the future".)

The durability test on paints made by paints and the latest technology of a tank inside coating that has results for about 20 years is executed, and the test methodology is verified and lie durability the applicability of the working curve is confirmed in 2002 fiscal year. The outline of the temperature inclination soaking examination of the durability tests is shown below.

(1)Test methodology?Three kinds of the vinyl ester resin glass flakes paints adjustment goods for sample [a] examination

- The one that bisphenol system vinyl ester resin (Hereafter, it is said, "BV resin") was used.

- The one that novolac system vinyl ester resin (Hereafter, it is said, "NV resin") was used.

- One kind of the results already-known vinyl ester resin glass flakes paints, that is, one (Hereafter, it marks, and the compounding ratio rate is marked with % behind each resin , saying that "BV resin/NV resin") [i] past to have used the BV resin together with the NV resin?It was examined by four kinds of the examination method paints (three kinds of the adjustment goods and past one kind of a results already-known material for the examination) and two levels (400,700 μ m) in the film thickness and two kinds (40°C /20°C,70°C/30°C) of the liquid temperature of soaking degree condition.

?Measurement and record item

Testing condition (70°C/30°C) continued the soaking examination to testing condition (40°C/20°C) for 30 days for the period until the swelling was generated in all the paint film test pieces. The paint film interfacestate after the measurement of the electrical resistance value and the electrostatic capacity of adhesiveness and the paint film and the examinations end is observed.

(2)Test outcome?Examination result [a] film thickness 400 μ m test piece in testing condition (40°C/20°C)

([a])Days until generating swelling

The swelling of four test pieces (BV resin GF coating paints and BV resin/NV resin GF coating paints, NV resin GF coating paints, and already-known paints of results) was both generated during the 97th day. It was analogized that the swelling had been generated between the 93rd day and the 97th day because the observation day before the day 97 was a day 92.

([i])Presumption at swelling generation years that uses working curve *

In the investigation examination in 2001 fiscal year, it was admitted that it was roughly

corresponding at the generation years of the swelling that applied the generation time of the swelling in the generation years of the swelling of the paint film in a real tank and the temperature inclination soaking examination to the working curve and requested it.

([a])It was thought that durability was possessed for about 20 years because it became 18?25 year when days until generating the swelling to [de] presumption were assumed the shortest the 93rd, it applied to the example of the working curve made an expression, and years until generating the swelling were presumed.

***About the working curve**

The working curve shows the correlation until time by the temperature inclination soaking examination until generating the swelling and generating the swelling in a real environment about the test piece made at identical terms, and the working curve used by this investigation examination is the one made based on the test data done in the past.

The working curve used by this investigation examination exposed the paint film of the sluice to seawater, and was made based on days until generating the swelling of obtaining by years and the temperature inclination soaking examination where the swelling of the paint film was generated.

[I] film thickness 700µm test piece

([a])Days until generating swelling

NV resin GF coating paints and a results already-known paints were analogized to have generated the swelling between the 98th day and the 110th day. BV resin GF coating paints were analogized to have generated the swelling in the 130th day from the 111st day. The swelling was not generated though 151 days passed about BV resin/NV resin GF coating paints.

([i])Presumption at swelling generation years that uses working curve

·It was thought that durability that exceeded 20 years was possessed because it became 19?27 year when days until generating the swelling of the presumption it was ahead ([a]) as for NV resin GF coating paints and a results already-known paints were assumed the shortest the 98th, it applied to the example of the working curve made an expression, and years until generating the swelling were presumed.

·It was thought that durability that exceeded 25 years was possessed about BV resin GF coating paints because it became 23?31 year when days until generating the swelling of the presumption ahead ([a]) were assumed to be the shortest 111 days, it

applied to the example of the working curve made an expression, and years until generating the swelling were presumed.

・It was presumed to have durability that exceeded 30 years because it became 33?46 year when it was assumed that the swelling had been generated from no generation of the swelling about BV resin/NV resin GF coating paints on the 152nd though 151 days passed, and presumed years until generating the swelling.

5.1. 2,011 fiscal year 4)

It examines it by investigating the deterioration of BV resin GF coating paint film that executes the temperature inclination soaking examination with the test piece that changes the resin composition and the film thickness to confirm the kind of the resin composition and the relation between the film thickness and the life and used it for 25 years or more in a real tank, and using the results of these for the weigh-in of [sen] making.

(1)Temperature inclination soaking examination

Kind of paints film thickness level total test piece make thermal gradient soak examination. Chiefly of the examination item, ..the external observation of the paint film (It is observed to crack ..the swelling..) , after before the maceration, it bends and it examines it the adhesion measurement, the hardness determination, the impact test, and the impedance measurement. It observes for 75 days after it begins to soak it every ten days, and it has executed it for 179 days. The outline of the soaking examination is shown below.

?Test methodology

[A] sample and test methodology

([a])Kind and film thickness of examination paints

Each of one test piece with the resin composition and the film thickness different was made by using BV resin GF coating paints and BV resin/NV resin GF coating paints. The kind of the made test piece : as shown in Table 5.1.1.

表 5.1.1 試験片の種類

膜厚(μ m)	①BV樹脂	②BV樹脂 70% /NV樹脂 30%	③BV樹脂 30% /NV樹脂 70%	④BV樹脂 20% /NV樹脂 80%
400	A1	B1	C1	D1
700	A2	B2	C2	D2
1000	A3	B3	C3	D3
1500	A4	B4	C4	D4

(note 1) A1?D4 shows the sign of the test piece.

(note 2) The glass flakes content was drunk and assumed 20 %(Wt%) in the resin paints.

([i]) Test methodology

- Soak solution: Water
- Temperature 40°C/20°C

[I] measurement and record item

The paint film external visual inspection is done every ten days on the 75th soaking examination day of 179 days the soaking period, and abnormalities of the swelling and the crack, etc. are confirmed with the unassisted eye. The physical properties examination (adhesion power examination, hardness determination, impact test, and impedance measurement) is executed before and after another and the soaking examination of the externals visual inspection. Moreover, the bend examination is executed after soaking is examined, and the moisture regime under the paint film and the confirmation of the corrosion situation are executed.

?Examination result [a] external observation

The swelling had been generated in A1, A2, C1, and the D1 test piece by the initial observation of the 75th day. The swelling was generated in the test piece of B1 on the 98th day. Table 5.1.2 shows days from which the generation of the swelling is confirmed.

表 5.1.2 温度勾配試験による各試験片の膨れ発生日数

試験片		浸漬日数	75日	80日	90日	98日	110日	119日	130日	140日	147日	159日	168日	179日
1500 μ m	D-4													
	C-4													
	B-4													
	A-4													
1000 μ m	D-3													
	C-3													
	B-3													
	A-3													
700 μ m	D-2													
	C-2													
	B-2													
	A-2													
400 μ m	D-1													
	C-1													
	B-1													
	A-1													
観察日			10/4	10/19	10/29	11/9	11/18	11/27	12/8	12/18	12/25	1/6	1/5	1/26

(注 1) ×は試験片に膨れ発生が確認された日。なお、75日目より前には観察を行っていない。

(2) Paint film deterioration investigation of real tank

To examine the relation to the deterioration of the film thickness and the paint film, the deterioration of BV resin GF coating paint film of the real tank (3) used by about 26 years is investigated.

?Search procedure

After the visual inspection and the film thickness measurement were executed centering on the paint film from construction, it rusted, it peeled off, it cracked, and the generation part such as the swellings was extracted, the bottom board was classified into division into four according to the swelling situation of the occurrence. Range (0.5m×0.5m) of the observation from the division into 4 to each division 2 places was selected, and the state observation of the selected range under the film thickness measurement, the adhesion power examination, the impedance measurement, the hardness determination, and the paint film was executed.

The situation of the occurrence of the swelling assumes the following to be division into four according to the area ratio of the swelling.

A:(0%)、B:(0?0.1%)、C:(0.1?0.3%)、D:(0.3%?)

?Result of the survey

The film thickness used to be uniform in the [a] investigation tank, and a plain relation was not seen in the film thickness and the situation of the occurrence of the swelling. (The tendency was seen a little in one.)Neither C nor D that the number of [i] swelling generation is a lot of have arrived at the corrosion of a remarkable steel material though were observed a part of black rust under the paint film.

It was confirmed that the swelling phenomenon was maintained the healthy condition by about 26 years by 87% or more of the paint film when [u] was constructed, and did not exist moreover in the state that tended to concentrate on a certain direction of the tank bottom board partially, to be generated, and to lie scattered in the whole.

The repair is properly performed at the time of each opening, and it has been understood that the problem of the swelling that originates on the paints side if it is average film thickness 800μm level and is generated is few from the above-mentioned in the real tank paint film used about 26 years. The generation factor of a constant level of the swelling partially generated was thought for the possibility to be able to narrow to exist depending on extracting the problem on the environment when constructing it and the environment when using it.

(3)Result of review concerning making working curve

The result of review to make the working curve of the GF coating paints was as follows.

?It is necessary to fix accurate swelling generation days about the temperature inclination soaking examination about the test piece of 400μm and 700μm (BV resin GF coating paint film). It was proposed that the one of real tanks used at the normal temperature execute the examination paying attention to this resin composition because there were a lot of one of the BV resin composition.

?In investigation of actual conditions, the thickness distribution is almost 700μm? in the investigated tank. It was a range of 1,000μm, and to make the working curve by using this data, it was proposed to investigate the tank constructed by average film thickness 400μm in BV resin GF coating paints.

5.1.3 Review method in this fiscal year

It was assumed that 40°C/20°C temperature inclination soaking examination was executed to receive the result of review of 5.1.1 and 5.1.2, and to obtain the test data assumed to be a problem at current year. Moreover, collecting the paint film deterioration situation of the bottom coating of real film thickness 400μm level was investigated to evaluate the life of the paint film in a real tank, and the repair results data of the GF coating of a real tank was analyzed.

References cited

- 1)Hazardous Materials Safety Techniques Association: March, investigation examination report and 2001 concerning performance regulations making lie method of specific outdoor tank reservoir of calculating cycle of open
- 2)The Ministry of Public Management, Home Affairs, Posts and Telecommunications Fire and Disaster Management Agency: March, investigation examination report and 2002 concerning method of specific outdoor tank reservoir of calculating cycle of open
- 3)The Ministry of Public Management, Home Affairs, Posts and Telecommunications Fire and Disaster Management Agency: March, investigation examination report and 2003 concerning safety estimate of outdoor storage tank
- 4)Hazardous Materials Safety Techniques Association: Examination investigation report book on evaluation of coating of outdoor storage tank at the life and March, 2010

5.2 Temperature inclination soaking examination of test piece that gives the glass flakes coating

To contribute to the examination of BV resin GF coating paint film at the life, the temperature inclination soaking examination that changes the film thickness and the resin composition of the paint film is done. The external observation frequency was executed to understand accurate swelling generation days every five days, and the number of test pieces was assumed to be three when examining it.

5.2.1 Temperature inclination soaking examination method

(1) Examination period

Two in June, 2010?September 10, 2010 (100 days)

(2) Examination sample?Kind of examination paints

A:BV resin GF coating paints

B:GF coating paints by mixing BV resin 70%/NV resin 30%

?Kind and sign of test piece

Table 5.2.1 shows the kind and the sign of the test piece.

表 5.2.1 試験片の種類と記号

膜厚(μ m)	B V樹脂 100%	B V樹脂 70%/ N V樹脂 30%
400	A 1-1~3	B 1-1~3
700	A 2-1~3	—

(note 1)The sign such as A1-1 in the table is a name of the test piece.

(note 2)The glass flakes content was assumed to be 20wt% within the range of content (15?27%) of the glass flakes that existed in "Indicator concerning the coating" referring to contents of manufacturers.

(3) Making of test piece

The test piece was made for 2009 fiscal year in a similar way, and the surface-roughness was measured at current year.

?Material: SS400 Sand blast processing (Processing grade; ISO 8501-1 Sa3 and abrasive material; 46 alumina meshes and surface-roughnesses RZ:20?22 μ m) ? size: 150 \times 70 \times 3.2 the kind and two kinds of the mm ? test piece of the number of sheets [a] paints: A and two levels in B [i] film thickness: A:400 μ m, 700 μ m, and B:400 μ m [u] test piece or more n: 3(nine pieces in total) The examination paints (painting on first coating +) were painted on the surface of [a] of the method of making ? test piece so that the dry film might become a prescribed film thickness. To become 300?350 μ m by the epoxy resin paint, the back was painted. The board surrounding was painted to come in succession

in the paint film in the inside and outside by about 5mm, it wrapped, and the leaving dryness was done at the normal temperature for seven days.

The first coating diluted 2% and painted the brush, and 1% was diluted and the GF coating was painted in [earesusupure-] (60:1 compared with 163-531 and 1st chip pressure 3.5kg/cm² and the pump). It was assumed one day layer, and painted with 23°C in temperature and humidity 60%RH or less.

[I] film thickness and painting frequency

• 400 μ m:3 time paint

• 700 μ m:4 time paint

After it had painted, the film thickness was measured by 100 points of each test piece.

?Test piece making record and film thickness measurement result

Tables 5.2.2 and 5.2.3 show the record concerning the test piece making.

表 5.2.2 塗装工程記録

試験片記号	樹脂組成	膜厚 (μ m)	下塗	上塗一層目	上塗二層目	上塗三層目
A1	B V樹脂	400	5/7	5/10	5/11	-
A2	100%	700	5/7	5/10	5/11	5/12
B1	B V樹脂 70% / N V樹脂 30%	400	5/7	5/10	5/11	-
温 度 (°C)			22	22	23	23
湿 度 (%)			50	50	60	55

(note)The back: 5/17 and edge painting 5/18 of ..painting.. ..5/13.. further the second 5/14 layers in case of epoxy resin paint (total 350μm)

表 5.2.3 試験片膜厚測定結果 (1枚あたりの測定点 100カ所)

試験片記号	樹脂組成	膜厚 (μ m)	平均 (μ m)	最小 (μ m)	最大 (μ m)	標準偏差 (μ m)
A1-1	B V樹脂	400	538	425	680	67.3
A1-2			535	411	687	69.0
A1-3			535	421	680	59.6
A2-1	100%	700	837	703	954	65.9
A2-2			832	711	950	58.4
A2-3			829	710	946	49.2
B1-1	B V樹脂 70%/ N V樹脂 30%	400	538	412	728	69.7
B1-2			538	422	723	68.6
B1-3			534	408	684	66.9

(4)Temperature inclination soaking examination machine?Figure 5.2.1 shows the installation position of the outline temperature inclination soaking examination machine and the test piece of the temperature inclination soaking examination machine. The maceration water used tap water.



図 5.2.1 温度勾配浸漬試験器及び試験片取付け位置

?Temperature management under examination

Temperature conditions were assumed to be 40°C on the surface side and 20°C on the back side. The temperature measurement record of 100 days was $\pm 1.0^{\circ}\text{C}$, and the change of the temperature was a range of the target. Moreover, it is judged that the difference and bias of the temperature by the installation position are hardly seen, and this examination was done under an excellent management situation.

(5) Observation and evaluation. It observed, it evaluated every observation frequency five days, and the observation by the WG committee was executed properly.

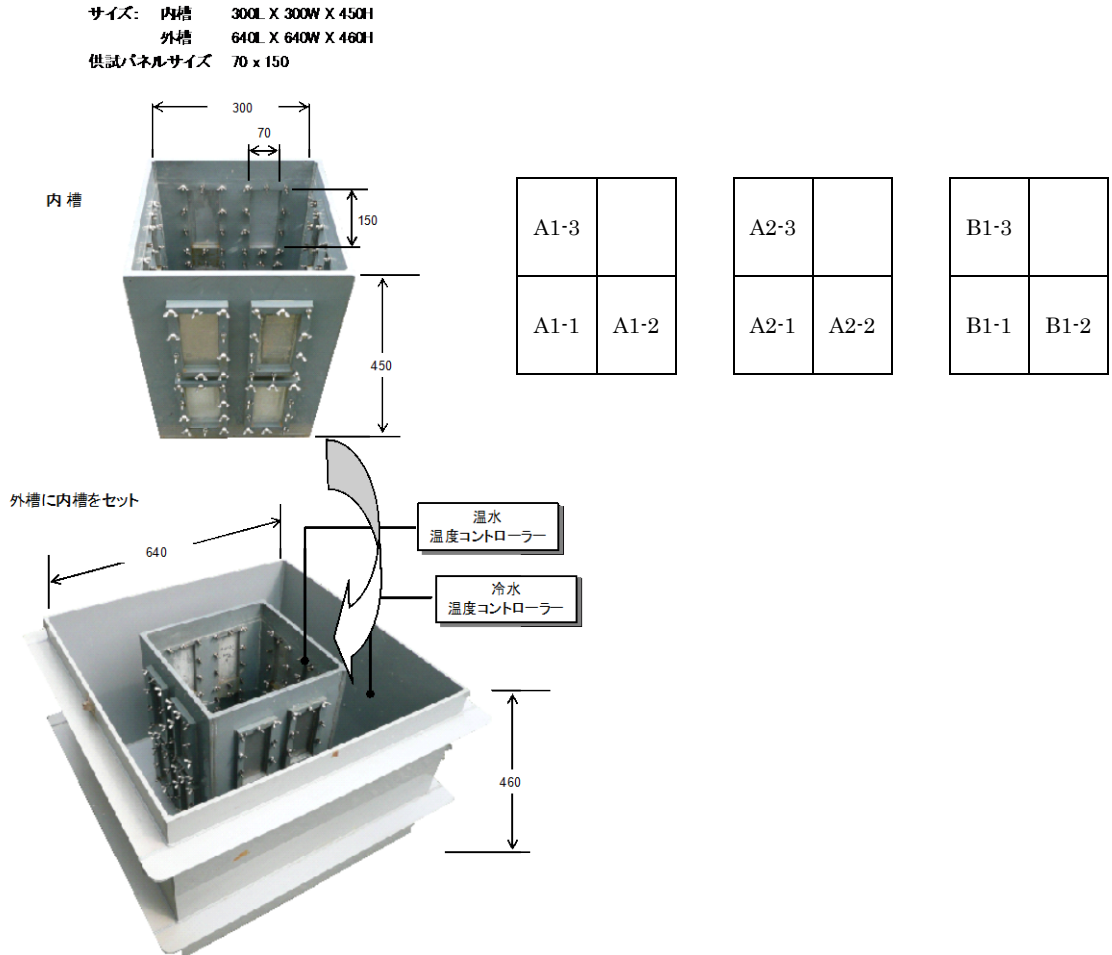
?Evaluation and taking a picture of swelling

It observed, it evaluated with the unassisted eye, and it took a picture of the swelling of the paint film (size of presence and the swelling) and the cracks, etc. immediately after the temperature inclination examination machine was drained.

Definition of [a] swelling

The phenomenon of partially of the paint film coming between the parent material surface or the paint film layers to the surface is said the swelling.

[I] criterion

It evaluates it as shown in Table 5.2.4 based on ASTM D714-02 "Standard testing method to evaluate extent to be able to do the blister of paints".

表 5.2.4 膨れの評価

密度 大きさ	F	M	MD	D
8	○	○	×	×
6	○	×	×	×
4	×	×	×	×
2	×	×	×	×

○：小さい膨れのため確認できない範囲

×：膨れの確認ができる範囲

(6) Physical properties examination

The external observation of the temperature inclination soaking examination and the physical properties examination after the temperature inclination soaking examination had ended were done according to the following procedure.

?External observation of paint film

The swelling of the paint film (size and density of presence and the swelling) and abnormalities of the crack etc. were observed in the naked eye according to the following procedure.

The tank in the [a] temperature inclination examination machine is drained, and the installation frame is taken out.

The test piece is detached at once, and [i] is soaked in 40°C warm water before it dries.

One [u] test piece is taken out, it observes in a first of all wet state, paper Wess wipes

moisture off next, the light is applied from side, and the swelling etc. are observed.

When the swelling is confirmed while observing [e], outer of the swelling is marked with the pencil.

Because it becomes impossible to dent, and to confirm the swelling while observing [o], the work of [u] and [e] is continuously done.

ASTM D714-02 standard photograph is used, evaluated, and the size and the density of the [kama-ku]ed swelling are recorded.

?Adhesion measurement ([puruofu] method)

After externals had been observed, adhesiveness only by a vertical [hi] tension ..cocking.. was evaluated with [ha] examination machine (model 106-2) to measure the adhesion power of the paint film after the soaking examination had ended.

?Hardness determination (bar col sclerometer)After externals had been observed after the soaking examination had ended, the hardness of the paint film was evaluated with the bar col sclerometer (934-1 types) to measure the hardness of the paint film.

?Impact test (Dupon type impact test)

Peeling off and the crack after the harpoon (500g in 6.35mm in the radius ×300mm in height × mass) was dropped to the paint film under a constant condition after the soaking examination ended to evaluate the shock strength-proof of the paint film and it transformed it were confirmed.

?Impedance measurement

After the soaking examination had ended, the impedance measurement (It measured the exchange resistance and the capacitance value and was a change into the frequency or a change with the lapse of time of resistance) was done to evaluate the degradation level of the paint film quantitatively.

?Bend examination

The test piece was bent to confirm the influence of the moisture that infiltrated into the paint film and moisture that reached the flux line after the soaking examination had ended, the paint film was peeled off compulsorily, and the state under the paint film was observed with the unassisted eye.

The test piece did one remainder by making 4 pieces, and using 3 pieces for the soaking examination, and it drank and [tame] effect was done without doing the soaking examination for an initial paint film physical properties value measurement. The test outcome of this test piece is expressed as follows as an initial value of each physical properties value.

5.2.2 Temperature inclination soaking examination result

Is the temperature inclination soaking test data a reference? Eight references

(1) Outline of external observation result

Table 5.2.5 shows the external observation result list.

One swelling was confirmed to A1-1, A1-3 (BV resin and film thickness 400 μ m), and A2-3 (BV resin and film thickness 700 μ m) respectively by the observation of 55 days after the start of the examination. The swelling was confirmed to A1-2 and A2-2 during the 58th day, and the swelling by 1 piece was confirmed to B1-3 (BV resin 70%/NV resin 30% and film thickness 400 μ m) during the 65th day. A2-1 was confirmed on the 70th day afterwards, the swelling was confirmed to B1-2, the swelling was confirmed as for B1-1 on the 85th day, and the swelling was admitted in all test pieces (The test piece observation situation photograph is published in the reference).

The number of swelling generation of the 100th days was A1:9?17 piece and A2:8 (12 on the average)(8 on the average) piece and B1:5?7 (6 on the average) pieces, and there were a lot of A1, and A2 and B1 showed few tendencies. Refer to Figure 5.2.2 for the relations between the swelling generation number and the number of maceration Japan of each test piece.

The swelling area of the 100th day showed few tendencies in order of % and A1:3.9?6.5 % and A2:3.6?4.6 (4.8 on the average)(4.2 on the average) B1:2.0?3.3 (2.8 on the average)%.

The relations between the swelling area and the number of maceration Japan of each test piece were summarized in Figure 5.2.3. A1-1 is in three test pieces of A1(400 μ m) and it is in the swelling situation of the occurrence as for paints and the film thickness as which the swelling generation number and the area are a lot, and are the most same a plain difference. There is B1(400 μ m) by B1-1 in three test pieces, and the swelling generation is most and it is late in the swelling situation of the occurrence in the same paints and the film thickness the difference. The difference is hardly admitted by three pieces in A2(700 μ m).

表 5.2.5 温度勾配浸漬試験結果一覧

上段は膨れ発生個数

試験塗料	膜厚(μm)	記号	外観観察結果									
			5	9	15	20	23	30	35	40	44	50
			6/7(月)	6/11(金)	6/17(木)	6/22(火)	6/25(金)	7/2(金)	7/7(水)	7/12(月)	7/16(金)	7/22(木)
BV系 100%	400	A1-1	○	○	○	○	○	○	○	○	○	○
		A1-2	○	○	○	○	○	○	○	○	○	○
		A1-3	○	○	○	○	○	○	○	○	○	○
	700	A2-1	○	○	○	○	○	○	○	○	○	○
		A2-2	○	○	○	○	○	○	○	○	○	○
		A2-3	○	○	○	○	○	○	○	○	○	○
BV系/NV系 70%/30%	400	B1-1	○	○	○	○	○	○	○	○	○	○
		B1-2	○	○	○	○	○	○	○	○	○	○
		B1-3	○	○	○	○	○	○	○	○	○	○
試験塗料	膜厚(μm)	記号	外観観察結果									
			55	58	65	70	75	79	85	90	93	100
			7/27(火)	7/30(金)	8/6(金)	8/11(水)	8/16(月)	8/20(金)	8/26(木)	8/31(火)	9/3(金)	9/10(金)
BV系 100%	400	A1-1	13 2M	15 2M	16 2M	16 2M	16 2M	16 2M	16 2M	16 2M	17 2M	17 2M
		A1-2	○ 2F	2 2F	2 2F	2 2F	7 2F	9 2F	10 2F	10 2F	10 2F	10 2F
		A1-3	4 2F	5 2F	7 2F	7 2F	7 2F	8 2F	8 2F	9 2F	9 2F	9 2F
	700	A2-1	○ 2F	○ 2F	○ 2F	3 2F	4 2F	6 2F	6 2F	8 2F	8 2F	8 2F
		A2-2	○ 2F	5 2F	5 2F	6 2F	6 2F	6 2F	7 2F	8 2F	8 2F	8 2F
		A2-3	1 2F	3 2F	3 2F	6 2F	7 2F	7 2F	8 2F	8 2F	8 2F	8 2F
BV系/NV系 70%/30%	400	B1-1	○ 2F	○ 2F	○ 2F	○ 2F	○ 2F	○ 2F	3 2F	4 2F	4 2F	5 2F
		B1-2	○ 2F	○ 2F	○ 2F	2 2F	3 2F	4 2F	5 2F	6 2F	6 2F	6 2F
		B1-3	○ 2F	○ 2F	1 2F	3 2F	3 2F	4 2F	4 2F	7 2F	7 2F	7 2F



図 5.2.2 各試験片の膨れ発生個数と浸漬日数



図 5.2.3 各試験片の膨れ面積率と浸漬日数

(2) Consideration of external observation result? The swelling had already been generated in film thickness 400µm of BV resin GF coating paints and the paint film of 700µm in the experiment on the film thickness in 2009 influence fiscal year on the 75th day of the observation first time day. This time, it was confirmed that days until generating of the paint film of film thickness 400µm of BV resin GF coating paints and 700µm the swelling were days 55?70 (the average the 61st) respectively on 55?58 day (the average the 56th) as a result of observing every five days. There is little difference in the swelling situation of the occurrence in the paint film of the same paints of 700µm in the film thickness, and moreover, the controlling effect of the moisture penetration of the paint film of 700µm in the film thickness is higher than the paint film of 400µm in the film thickness and with stability though a big difference is in the swelling situation of the occurrence in the same paints and the film thickness in the paint film of 400µm in the film thickness.

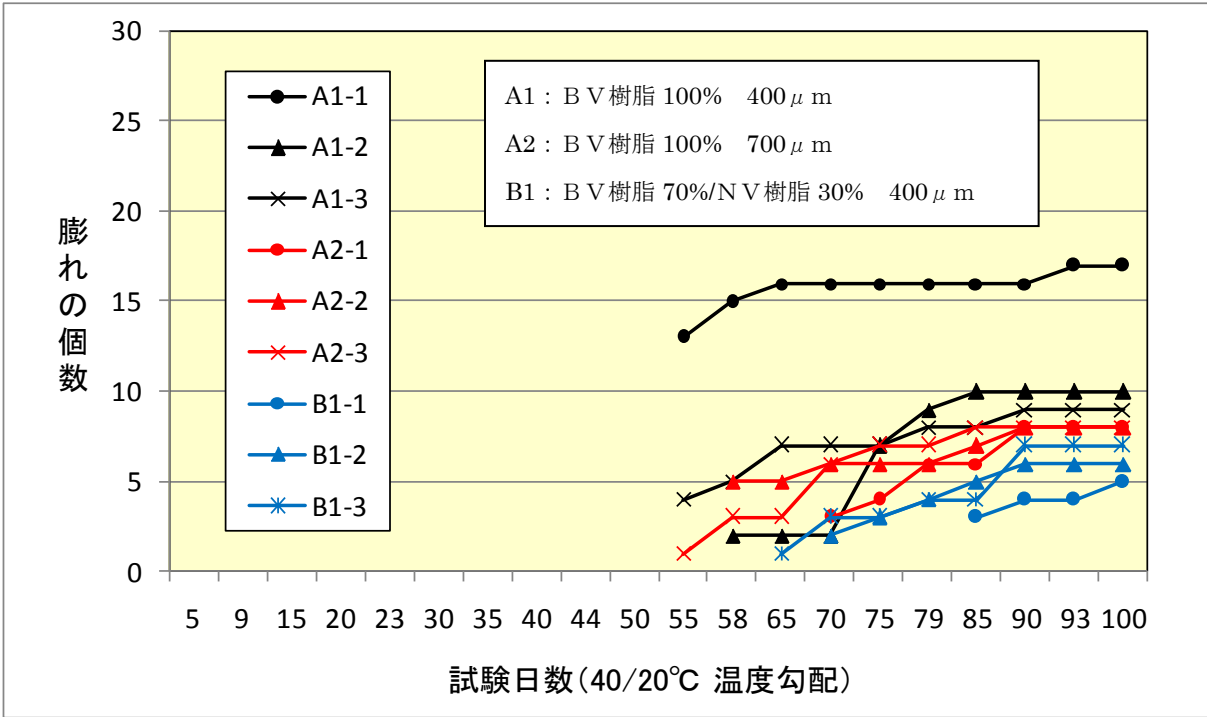
?Influence with resin

Days until generating of the paint film of 400µm in the film thickness of the GF coating paints of BV resin 70%/NV resin 30% the swelling are 65?85 (the average the 73rd), BV resin/NV resin swells compared with the paint film of 400µm in the film thickness of BV resin GF coating paints, days until generating are long, and the swelling generation number is also little. In addition, BV resin/NV resin swells in spite of the difference of the film thickness when the paint film of 400µm in the film thickness of BV resin 70%/NV resin 30% paints is compared with the paint film of 700µm in the film thickness of BV resin GF coating paints and days until generating are long. It was confirmed that there was a significant difference in durability from the above-mentioned by the resin composition.

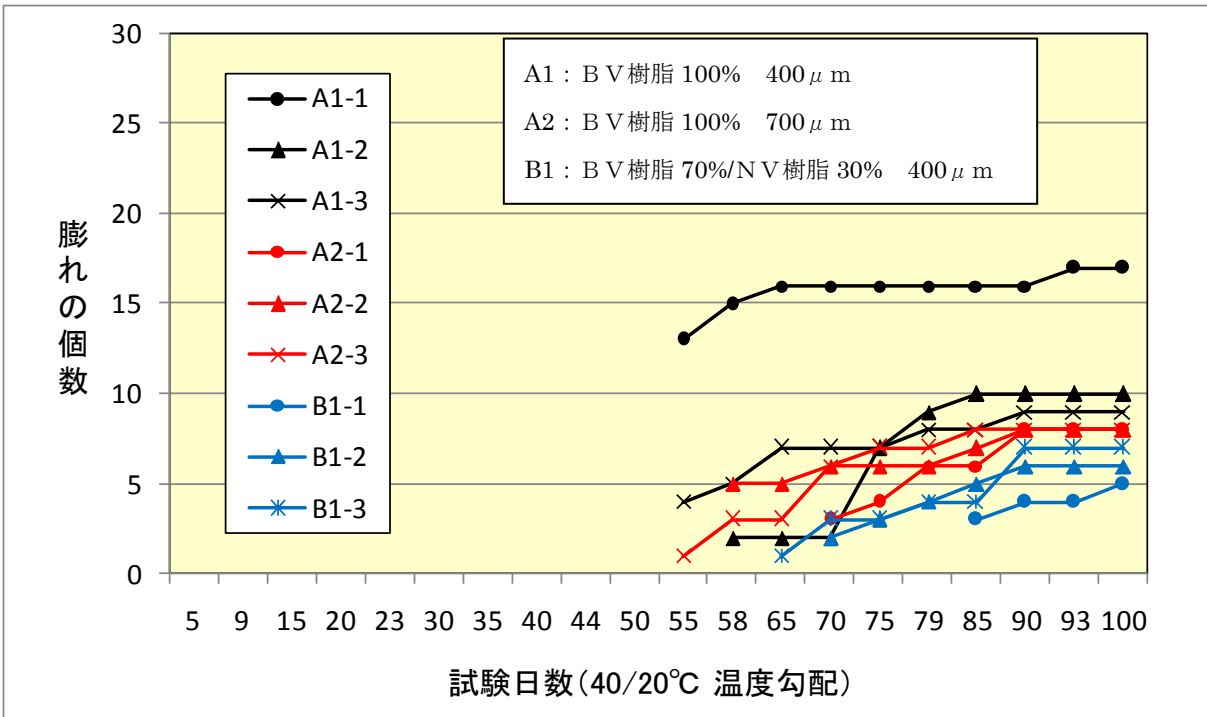
(3) Physical properties examination result

The result of the adhesion measurement, the hardness determination, the impact test, the impedance measurement, and the bend examination was summarized in Table 5.2.6.

?Outline of physical properties examination result

The adhesion power after the [a] soaking was examined was 4MPa or more and the breaking part was cohesive failure (100%) of the first coating. The strength retention is 65% compared with an initial value and it is not abnormal.

The [iba-koru] hardness is 40 or more all test pieces, a value that changes an initial

value and hardly, and the softening tendency to the paint film is not seen.

Flaking off and the crack there were not and were not abnormal though were able to dent in the impact part in all [u] impact test.. test pieces.

When the [e] paint film was compulsorily peeled off, and the state of the flux line in the swelling part by the moisture penetration was confirmed, moisture and moisture [**] were admitted in the swelling part. Rust was not admitted.

As for the electrical property by the [o] impedance measurement, it was more than all 107Ω and the deterioration tendency was hardly seen though the thin film showed some low resistance compared with an initial value.

It can be said that the chemical deterioration of the paint film like the swelling and the resolution, etc. will hardly progress from the above-mentioned.

表 5.2.6 物性試験結果一覧

物性試験結果（膜厚、付着性、硬度、衝撃）

試験板 記号	膜厚 (μm)				付 着 性				硬 度		衝 撃 試 験	
	平均	最小	最大	標準偏差 (μm)	初期値	破断箇所	試験後	破断箇所	初期値	試験後	初期値	試験後
					(MPa)		(MPa)		(N・コル)	(N・コル)	(テ・コボ・ン式)	(テ・コボ・ン式)
A 1 - 1	538	425	680	67.32	5.0	下塗100%凝集破壊	4.3	下塗100%凝集破壊	42	40	異常なし	異常なし
A 1 - 2	535	411	687	68.98			4.7			40		異常なし
A 1 - 3	535	421	680	59.55			4.5			40		異常なし
A 2 - 1	837	703	954	65.88	7.0	下塗100%凝集破壊	4.5	下塗100%凝集破壊	42	40	異常なし	異常なし
A 2 - 2	832	711	950	58.37			4.5			41		異常なし
A 2 - 3	829	710	946	49.19			4.7			40		異常なし
B 1 - 1	538	412	728	69.66	5.0	下塗100%凝集破壊	5.2	下塗100%凝集破壊	48	44	異常なし	異常なし
B 1 - 2	538	422	723	68.60			5.0			45		異常なし
B 1 - 3	534	408	684	66.88			5.0			44		異常なし

物性試験結果（インピーダンス測定）

試験板	インピーダンス測定																	
	抵抗値 ($\times 10^6 \Omega$)						容量 ($\times 10^{-3} \mu F$)						tan δ					
	200Hz		500Hz		1000Hz		200Hz		500Hz		1000Hz		200Hz		500Hz		1000Hz	
	初期値	試験後	初期値	試験後	初期値	試験後	初期値	試験後	初期値	試験後	初期値	試験後	初期値	試験後	初期値	試験後	初期値	試験後
A 1 - 1		133		44		27		0.073		0.071		0.068		0.096		0.095		0.094
A 1 - 2	667	200	250	77	133	42	0.045	0.068	0.044	0.068	0.043	0.068	0.014	0.062	0.012	0.060	0.031	0.062
A 1 - 3		200		75		40		0.065		0.065		0.063		0.064		0.066		0.069
A 2 - 1		267		153		80		0.040		0.042		0.041		0.051		0.048		0.050
A 2 - 2	667	400	267	200	143	86	0.039	0.040	0.039	0.041	0.038	0.040	0.012	0.050	0.010	0.047	0.006	0.050
A 2 - 3		400		133		67		0.050		0.050		0.048		0.052		0.051		0.050
B 1 - 1		400		100		57		0.070		0.070		0.068		0.052		0.049		0.050
B 1 - 2	667	400	250	133	133	57	0.049	0.065	0.049	0.064	0.048	0.062	0.013	0.052	0.012	0.049	0.007	0.050
B 1 - 3		400		100		50		0.068		0.067		0.065		0.052		0.050		0.051

5.2.3 Summary

(1)The swelling generation days of the paint film by the temperature inclination soaking examination were admitted the paint film of 400 μ m in the film thickness of BV resin GF coating, 55?58 (56 on the average) day, 700 μ m, 55?70 (61 on the average) day, and to have the difference in durability depending on the film thickness.

(2)A big difference was in the swelling situation of the occurrence in the same paints and the film thickness in the paint film of 400 μ m in the film thickness. On the other hand, there is little difference in the swelling situation of the occurrence in the paint film of 700 μ m in the film thickness, and an effect of controlling the penetration of moisture compared with the paint film of 400 μ m in the film thickness high, steady durability is possessed.

(3)The paint film of 400 μ m in the film thickness of the GF coating of BV resin 70%/NV resin 30% showed durability that was more excellent than the paint film of 400 μ m in the film thickness of BV resin GF coating.

5.3 Investigation of paint film deterioration situation in real tank

The deterioration situation of the coating paint film of average film thickness 400 μ m level in a real tank was local investigated aiming to obtain the data to examine the life of the paint film in a real tank.

In the examination done in 2002 fiscal year, it is said that it is also possible to verify the performance between long terms or more by accumulating the results data of the life of the coating with a real tank. Moreover, it was said that an actual data collection of the swelling generation years in a real tank was necessary, and the data of the film thickness of the swelling generation years other than the one of 700 μ m in the average film thickness were necessary in the examination in fiscal year 2009 for the weigh-in of [sen] making. The paint film deterioration situation of BV resin GF coating of about 400 μ m in the average film thickness used by about 20 years in the tank of the schedule of open considering the realities of the thickness of the paint film used domestically this year was investigated now.

5.3.1 Selection of tank where local investigation is executed

This year, open schedule tank use average film thickness resin coating paint film site investigation possible tank how investigation execute. The condition of the object tank was as follows.

- Specific outdoor tank reservoir
- The one to construct GF coating to tank bottom and for 20 years or more to pass
- The one that paints with NV resin are not mixed with material of coating
- The real film thickness of the coating is the one before and behind 400 μ m.
- The one to preserve data of repair of coating (Understand the rate (ratio to the entire area) at which the coating was repaired when opening it (The weld is excluded)).
- The one that is not warming tank

The tank volume, contents, and the investigation schedule were considered, and the following three was selected as an object tank though 20 candidate tanks went up from the above-mentioned condition.

表 5.3.1 調査対象タンクの概要 (膜厚及びコーティング経過年数は選定時の聞き取り値)

タンク名	油種	概略容量 (k ℓ)	コーティング経過年数	推定膜厚 (μ m)
Aタンク	原油	67,000	30	255~390
Bタンク	原油	23,000	30	270~336
Cタンク	軽油	13,800	24	280~690

5.3.2 Local investigation item

When do the investigation of actual conditions of the paint film deterioration situation in a real tank, the search procedure in fiscal year 2009 was followed, and assorted traits were made as follows.

(1) Watching investigation

It rusted, it peeled off, it cracked, it swelled, externals of the deterioration of other paint film were observed, and the site of incidence was recorded in tank board crack figure. About the generation part of the swelling, it observed, it recorded in detail, and the generation area of the swelling was classified into division into four. When classifying it, all sides 0.5m are extracted. The range of swell situation of the occurrence of rust judgment standard chart referring to following. It classified it into the division of D into four. After watching was investigated in the locale, the extracted part was conferred and selected.

()The numerical value in the inside is A(0%), B(0?0.1%), C(0.1?0.3%), and ratio D of the swelling generation area to the area of the evaluation object (0.3% or more).

(2) Film thickness measurement

To examine the relation between the state of deterioration and the film thickness of the paint film, the film thickness ten points a bottom board was measured with an electromagnetic film thickness meter. Moreover, the film thickness was measured by 100 points by the part (Each division two places are extracted) with all sides of 0.5m extracted by (1) divided into four.

(3) State observation under paint film

(2)The paint film of the part to which [de] was extracted for the evaluation in the surrounding was stripped off within the range of 10cm×10cm, and the state (black [sabi**] etc.) under the paint film was confirmed.

(4) Film thickness measurement in paint film section

(3)The film thickness of the each level was measured from the section of the paint film that was [dehagi] [to], and it took a picture of the photomicrograph in the paint film splinter section.

(5) Physical properties examination

The adhesion measurement, the impedance measurement, and hardness of the part for the evaluation and the extracted part was examined.

?Adhesion measurement

To confirm the adhesiveness of the paint film, the adhesion power and the breaking part were measured by the adhesion examination. The adhesive was used, the treatment device made of aluminum was installed in the paint film, a surrounding paint film was pulled by ..cocking.. using [ha] examination machine after it had cut it, and strength when destroying it was measured.

?Impedance measurement

To confirm the paint film deterioration tendency, resistance and the capacity value were measured. The film thickness of the measurement part was measured by ten points a place with the electromagnetic film thickness meter, and the average film thickness, the maximum film thickness, and the minimum film thickness were requested. The electrode board of the aluminum foil of 10cm×10cm was put on the surface of the paint film with the adhesive of electroconductive, and the exchange impedance of the paint film (resistance and capacity value) was measured one hour later.

?Hardness determination

To confirm the hardness of the paint film, it measured it by three points with the bar col sclerometer.

5.3.3 Result of the survey of paint film deterioration situation in real tank

Is details of the result of the survey of the paint film deterioration situation in a real tank references?Refer to 9?1?3.

(1)A tank

?Investigation day: 11th and 12th in August of 2010

?Tank parameter

- Roof model: Floatage roof type
- Capacity: 67,147 kiloliters and inside diameters: 67m
- Oil kind: Crude oil
- Tank completion year: 1966
- There is no heating coil.

?The painting history and the specification are shown below.

History		Process	Paint Name	Standard Thickness(μm)	Remarks
First Opening	1971/10	Surface Preparation	Unknown	Unknown	—
		First Layer	Unknown	Unknown	
		Second Layer	Unknown	Unknown	
		Third Layer	Unknown	Unknown	
		Resin ; Unknown		Unknown	
History		Process	Paint Name	Standard Thickness(μm)	Remarks
Second Opening	1980/06	Surface Preparation	Blast(ISO Sa2.5)	Unknown	Bottom Plate; 1/5 Replacement Annular Plate; Whole Replacement
		First Layer	(Unsaturated Polyester Resin Under Coat)	Unknown	
		Second Layer	(Unsaturated Polyester Resin / Glass Flake Paint with Mica)	Unknown	
		Third Layer	(Unsaturated Polyester Resin / Glass Flake Paint with Mica)	Unknown	
		Resin ; Unsaturated Polyester		Unknown	
History		Process	Paint Name	Standard Thickness(μm)	Remarks
Third Opening	1988/06	Surface Preparation	Blast(ISO Sa2.5)	Unknown	Bottom Plate; Overlying, Patched Plate Repair Annular Plate; Overlying Repair
		First Layer	(Unsaturated Polyester Resin Under Coat)	Unknown	
		Second Layer	(Unsaturated Polyester Resin / Glass Flake Paint with Mica)	Unknown	
		Third Layer	(Unsaturated Polyester Resin / Glass Flake Paint with Mica)	Unknown	
		Resin ; Unsaturated Polyester		Unknown	
History		Process	Paint Name	Standard Thickness(μm)	Remarks
Fourth Opening	1996/02	Surface Preparation	Blast(ISO Sa2.5)	Unknown	Bottom Plate; Whole Replacement Annular Plate; Overlying Repair (Paint Reinforcement)
		First Layer	(BV Resin Under Coat)	Unknown	
		Second Layer	(BV Resin GF Paint)	Unknown	
		Third Layer	(BV Resin GF Paint)	Unknown	
		BV Resin ; Bisphenol System Vinyl Ester		Average:466 Minimum:370 Maximum:680	
History		Process	Paint Name	Standard Thickness(μm)	Remarks
Fifth Opening	2003/06	Surface Preparation	Blast(ISO Sa2.5)	Unknown	Bottom Plate, Annular Plate; Swelling(5·25mmφ) Scattered Local De-lamination
		First Layer	(BV Resin Under Coat)	Unknown	
		Second Layer	(BV Resin GF Paint)	Unknown	
		Third Layer	(BV Resin GF Paint)	Unknown	
		BV Resin ; Bisphenol System Vinyl Ester		250 Over	

?Investigation position

The photograph in the part extracted to the evaluation is shown below.

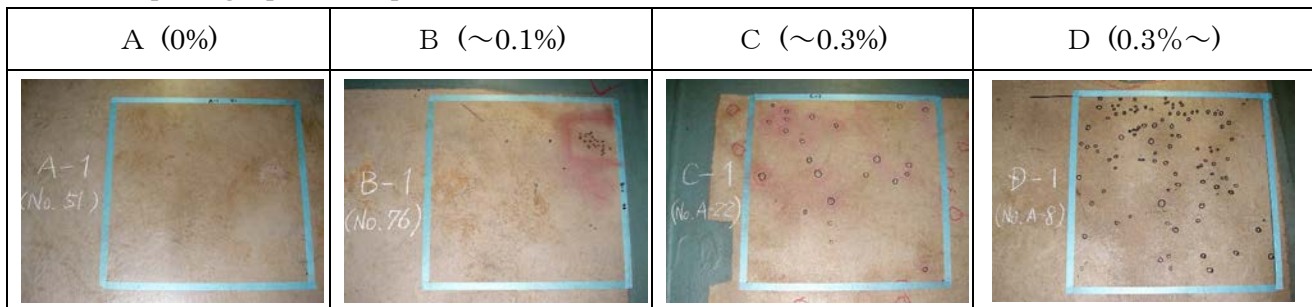

?Result of the survey

[A] externals watching

All aspects are changed for the bottom plate when the 4th is opened, and BV resin GF coating is given. When the 4th is opened from the paint film constructed when the overall changing is done when the 2nd is opened, the reinforcement painting is given with the same paints as the bottom plate as for the [anyura] board. The swelling was hardly and maintained an excellent state of the paint film though passed from construction in the bottom plate in this investigation 14 years. However, the swelling is generated in the whole on the [anyura] board, and the form of the swelling is a swelling from foundation. A? of extraction parts1 and B?One is a bottom plate, and, besides, [anyura] board.

[I] film thickness measurement

When all aspects of the tank were seen, the film thickness of the unrepair part of the paint films that had been constructed when 183 pieces in the bottom plate and 219 the 4th of 36 [anyura] boards in total were opened was mean value 574 μ m, maximum value 1162 μ m, and minimum value 393 μ m. When the bottom plate and the [anyura] board were divided, mean value 517 μ m, maximum value 661 μ m, minimum value 393 μ m, and the [anyura] board were mean values 866 μ m, maximum values 1162 μ m, and minimum values 626 μ m in the bottom plate. As for the film thickness of swelling generation division (A?D) into four, the mean value was 828 μ m in 390 μ m and the [anyura] board in the bottom plate as a result of measuring 100 points per each of 0.25 ?.

[U] adhesion measurement

Division A? with different swelling generation extentIt is health part A? in the bottom plate as a result of measuring the adhesion power of D. One was 4.0MPa, the situation of the fracture cross section was destruction from the adhesive, and high adhesiveness was confirmed. Moreover, B?. The bottom plate of one was 5.2MPa, the situation of the fracture cross section was a cohesive failure of final coating, and high adhesiveness was

admitted in the bottom plate paint film that had been constructed when the 4th was opened. On the other hand, it was destruction from a part near the cohesive failure and the iron foundation of the construction paint film when the 2nd was opened, and 1.0~4.2MPa and a low part were admitted in the [anyura] board where the paint film that had been constructed when the 2nd was opened under the reinforcement paint film remained as for the adhesion power.

[E] impedance measurement

Division A was a healthy value in both resistance and the capacity values. The part where a healthy value was indicated and the part where the deterioration tendency was shown were seen about division B and C. Both resistance and the capacity values showed the deterioration tendency in division D.

[O] hardness examination

Three point mean value of the bar col hardness is A? in the bottom plate. 1 and B?One was 30~40 in the [anyura] board, and tended though indicated a value high with 58 and 57 ..low...

Observation under paint film

A?1 and A?As for the health part paint film of two under, it was a situation in which there were little moisture penetration etc. and abnormality was not found. Moreover, B?. It is a swelling between layers where moisture doesn't infiltrate about the swelling part of two under the paint film, and it doesn't reach foundation. It is a swelling that hardly infiltrates under the paint film moisture of C and D, and doesn't reach foundation.

[Ki] paint film section measurement

The health parts of division A are 442 μm in the film thickness, and A?. As for one, black rust was slightly confirmed to the steel board side. Division B is 415 μm in the film thickness, and B?. Black rust was confirmed to the steel board side of one. The reinforcement painting was done as for division C, and the film thickness was 788μm, 819μm, and black rust was confirmed as for the steel board side. The reinforcement painting was done as for division D, and the film thickness was 748μm, 623μm, and black rust was confirmed as for the steel board side.

?Summary

The paint film passes about 14 years at the time of the investigation this time because all aspects are changed in 1996(open the 4th), and BV resin GF coating was done about the bottom plate though A tank passes from construction about 44 years. [Anyura] is guessed that the reinforcement painting was performed in 1996(open the 4th) because paints used are formed a new paint film on the paint film so that paints that contain the

mica flakes from the paints name are used as a result of the paint film section measurement and are used the same paints as the bottom plate though all aspects are changed in 1980(open the 2nd) and the GF coating is constructed when getting used.

In this investigation, BV resin GF coating was constructed, and only the paint film in the bottom plate was evaluated as a result because it had aimed for the film thickness to investigate the paint film about the one of about 400 μ m, and to evaluate the durability. The result is as follows.

It was a state to deterioration division B level (?0.1%) even if the swelling was hardly seen by the paint film in the bottom plate where about 14 years had passed since [a] was constructed, and the swelling existed, and a part deteriorated because of it was not admitted.

It was confirmed 517 μ m on the average the film thickness of the [i] bottom plate, and to maintain the state in which abnormality was not found for 14 years. It was not a plain moisture infiltration mark shown under the swelling of the paint film in general though a little moisture infiltration mark of ϕ 0.5mm or less was seen as for the state under the paint film.

Bottom plate..healthy..adhesion measurement..impedance measurement..hardness..examination..item..deterioration..tendency..see..state.

It can be judged that BV resin GF coating paint film of this investigation tank bottom board has durability from the result more than [e] for about 14 years or more at average film thickness 500 μ m level.

(2)B tank

?Investigation day: 27th and 28th in September of 2010

?Investigation day: 27th and 28th in September of 2010

?Tank parameter

- Roof model: Floatage roof type
- Capacity: 22,927 kiloliters and inside diameters: 38.74m
- Oil kind: Crude oil
- Tank completion year: 1980
- There is a heating coil (It is not used now though the use period is uncertain).

The painting history and the specification are shown below.

History		Process	Paint Name	Standard Thickness(μm)	Remarks
Initial Installation	1980/11	Surface Preparation	Blast(ISO Sa2.5)	—	—
		First Layer	(Unsaturated Polyester Resin Under Coat)	50	
		Second Layer	(Unsaturated Polyester Resin / Glass Flake)	150	
		Third Layer	(Unsaturated Polyester Resin / Glass Flake)	100	
		Resin ; Unsaturated Polyester		Min300	
History		Process	Paint Name	Standard Thickness(μm)	Remarks
First Opening	1988/05	Surface Preparation	Blast(ISO Sa2.5)	—	—
		First Layer	(Vinyl Ester Resin Under Coat)	Unknown	
		Second Layer	(Vinyl Ester Resin / Glass Flake)	Unknown	
		Third Layer	(Vinyl Ester Resin / Glass Flake)	Unknown	
		BV Resin ; Bisphenol System Vinyl Ester		Unknown	
History		Process	Paint Name	Standard Thickness(μm)	Remarks
Second Opening	1995/08	Surface Preparation	Blast(ISO Sa2.5)	Unknown	
		First Layer	(Vinyl Ester Resin Under Coat)	Unknown	
		Second Layer	(Novolac System Vinyl Ester / Glass Flake)	Unknown	
		Third Layer	(Novolac System Vinyl Ester / Glass Flake)	Unknown	
		NV Resin ; Novolac System Vinyl Ester		Unknown	
History		Process	Paint Name	Standard Thickness(μm)	Remarks
Third Opening	2003/03	Surface Preparation	Blast(ISO Sa2.5)	Unknown	Bottom Plate; Patched Plate Repairment
		First Layer	(Vinyl Ester Resin Under Coat)	Unknown	
		Second Layer	(Novolac System Vinyl Ester Resin / Glass Flake Paint)	Unknown	
		Third Layer	(Novolac System Vinyl Ester Resin / Glass Flake Paint)	Unknown	
		NV Resin ; Novolac System Vinyl Ester		Min250	

?Investigation position

The photograph in the part extracted to the evaluation is shown below.

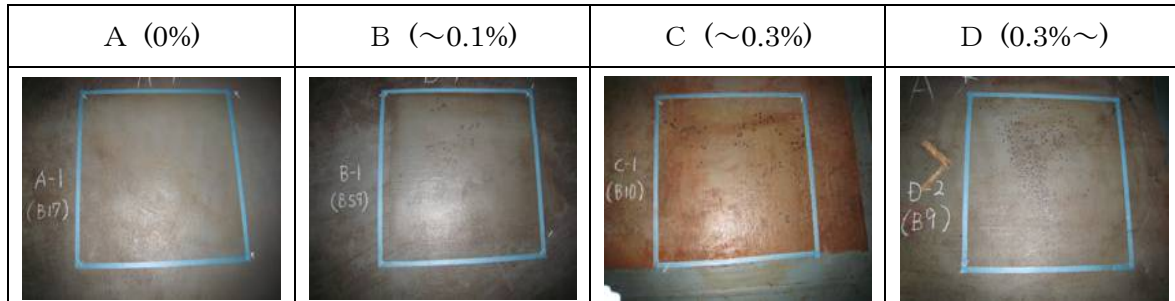

?Result of the survey

[A] externals watching

In the visual inspection, the swelling of the bottom plate has been widely generated. The generation of the swelling is a paint film with a thin seeming as the reinforcement painting and painting (about 100 μ m). Most swelling generation parts have been generated for an old paint film and final coating (green color). A healthy old paint film appeared when the reinforcement paint film was removed, and the swelling confirmed it did not reach the groundwork.

When constructing it, an existing paint film is a paint film, and when the 2nd is opened the 1st, the repair painting in the weld is done, and when the 3rd is opened, the reinforcement painting is done. The GF coating paint film constructed when constructing it will have passed with there no reinforcement painting in 'about 23. However, paints used were the use of an unsaturated polyester system resin.

[I] film thickness measurement

The film thickness of the unrepaired part that was constructed when constructing it with 65 pieces in the bottom plate and 33 98 [anyura] boards in total and reinforced when the 3rd was opened was mean value 909 μ m, maximum value 1111 μ m, and minimum value 656 μ m of all aspects of the tank. It was mean value 890 μ m, maximum value 1073 μ m, and was minimum value 681 μ m of the bottom plate, and moreover, it was mean value 946 μ m, maximum value 1111 μ m, and minimum value 656 μ m of the [anyura] board.

Mean value 766 μ m, 871 μ m of A, mean value 986 μ m, 705 μ m of B, and mean value 930 μ m and 700 μ m of C, and it was mean value 834 μ m, and 996 μ m of D as a result of measuring the film thickness of swelling generation division (A?D) into four by 100 points per each of 0.25 ?.

[U] adhesion measurement

Division A? with different swelling generation extentHealth part A in the bottom plate was destruction from an old paint film and the reinforcement paint film with 2.5MPa

and 4.0MPa as a result of measuring the adhesion power of D. Moreover, B?. The bottom plate of one is 6.2MPa, 40% is a cohesive failure of an old paint film, and the adhesiveness of an old paint film indicates a high value. As for division C and D, it was breaking between a reinforcement paint film and old paint film.

[E] impedance measurement

Division A?It was all of D and resistance and the capacity value were healthy values.

[O] hardness examination

Division A?There is little difference between the health part and the swelling part though it is all of D and 30?38 and some bar col hardness is low values.

Observation under paint film

B?The moisture penetration etc. are a situations under the paint film that are hardly and are not abnormal excluding two. The swelling was generated by the reinforcement paint film, and the penetration of the moisture to foundation was not seen. B?The infiltration of moisture was admitted under the paint film as for the swelling part of two, and black rust of about $\phi 20$? was admitted.

[Ki] paint film section measurement

There was a reinforcement paint film also in each division, and in the thickness of the reinforcement paint film, it was $67?173\mu\text{m}$ and an old paint film was $504?1152\mu\text{m}$. Moreover, minute black rust divides into the steel board side of division A ..seeing.. B?. Black rust was seen in D.

?Summary

As for the paint film of this [a] tank, about 30 years pass by the one constructed when constructing it. Judging from the paint film section, when the 2nd is opened the 1st, it seems that only flaking off and the restoration of the weld are done, and the reinforcement painting was done at the time of the 3rd opening (2003). The paint film in the bottom plate had been used for about 23 years before reinforcement was painted. It turned out that the use paints were paints of the unsaturated polyester resin.

There is about about $100?200\mu\text{m}$..the thickness of the reinforcement paint film..., and the film thickness of an old paint film is $700?800\mu\text{m}$ though the film thickness of the [i] bottom plate is an average and about $900\mu\text{m}$.

Even if the health part of the [u] bottom plate is put on the impedance measurement, adhesiveness, and the hardness determination, the deterioration tendency is not seen.

(3)C tank

?Investigation day: 14th and 15th in September of 2010

?Tank parameter

- Roof model: Fixed roof type
- Capacity: 13,771 kiloliters and inside diameters: 34.85m
- Oil kind: Light oil
- Tank completion year: 1970
- There is no heating coil (After the coating is constructed, eight years are used as a warming tank).

?The painting history and the specification are shown below.

There is no coating at the construction this time. The coating is not constructed at the time of the 1st opening (1979).

経 歴		工 程	塗 料 名	標準膜厚(μ m)	特記事項
第2回開放	1986年10月	素地調整	ブラスト(ISO Sa2.5)	—	内面腐食が多く発生していたのでコーティング施工 底板:当板、肉盛り補修(2,105個) 補修面積:1009㎡
		第1層	(ビニルエステル樹脂下塗塗料)	20	
		第2層	(ビニルエステル樹脂ガラスフレーク塗料)	300	
		第3層	(ビニルエステル樹脂ガラスフレーク塗料)		
		樹脂:BV樹脂		Min320	
経 歴		工 程	塗 料 名	標準膜厚(μ m)	特記事項
第3回開放	1994年 1月	素地調整	不明	—	加熱コイル撤去
		第1層	不明	不明	
		第2層	不明	不明	
		第3層	不明	不明	
		樹脂:不明		不明	
経 歴		工 程	塗 料 名	標準膜厚(μ m)	特記事項
第4回開放	2001年 5月	素地調整	不明	—	底板肉盛り補修(6個)
		第1層	不明	不明	
		第2層	不明	不明	
		第3層	不明	不明	
		樹脂:不明		不明	
経 歴		工 程	塗 料 名	標準膜厚(μ m)	特記事項
第5回開放	2008年 7月	素地調整	ブラスト(ISO Sa2.5)	—	底板:肉盛り補修(55個)
		第1層	(ビニルエステル樹脂下塗塗料)	50	
		第2層	(ビニルエステル樹脂ガラスフレーク塗料)	175	
		第3層	(ビニルエステル樹脂ガラスフレーク塗料)	175	
		樹脂:BV樹脂		Min400	

?Investigation position

The photograph in the part extracted to the evaluation is shown below.

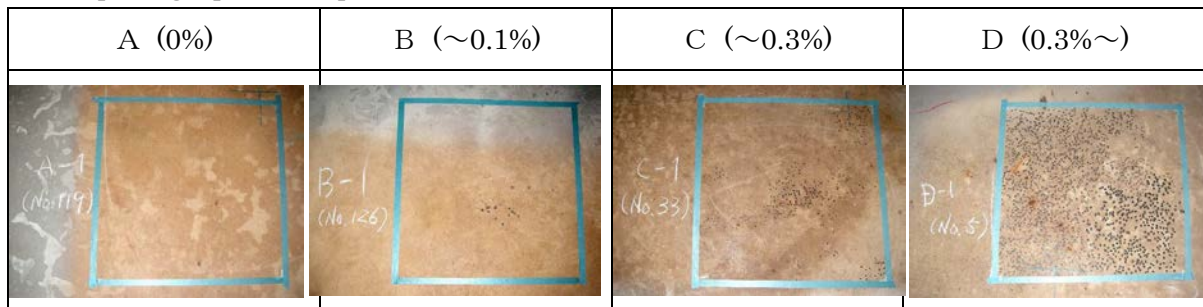

?Result of the survey

[A] externals watching

An existing paint film is a paint film constructed in 1986 judging from the history of this tank, and 24 years pass. As for the state of the paint film, the swelling of about 5mm has been generated on the bottom plate and the [anyura] board a lot. There was a part where the swelling had already destroyed and rust was generated, too and there was a pitting corrosion in the steel board under the paint film and rust was generated from the hole food in such a part.

[I] film thickness measurement

The film thickness of the part that was constructed in 127 pieces in the bottom plate, 12 139 [anyura] boards in total, and 1986, and not repaired afterwards was mean value 531 μ m, maximum value 1312 μ m, and minimum value 336 μ m of all aspects of the tank.

[U] adhesion measurement

Division A? of swelling generation extentIt is health part A? in the bottom plate as a result of measuring the adhesion power of D. One was destruction from the steel foundation with 7.0MPa and high adhesiveness was confirmed. Other parts were 2.5MPa or less, and division C and D that the generation of the swelling is a lot of were 2MPa or less. Moreover, the breaking part was broken because of the part where division B, C, and D were near foundation, and black rust like the swelling was confirmed to division D.

[E] impedance measurement

Division A is a healthy value in both resistance and the capacity values. Resistance and the capacity value showed the deterioration tendency in both division B, C, and D. Especially, division D was abnormal measurements.

[O] hardness examination

Three point mean value of the bar col hardness shows 40 or more in hardness in all the location of measurements, and the decrease tendency is hardly seen about hardness.

Observation under paint film

As for division A, the same black degree of rust as the swelling is scattered in abnormal bur and division B. The swelling part of division C and D was thought that the penetration of moisture was remarkable, and a lot of black rust was confirmed.

[Ki] paint film section measurement

The health part of division A was film thickness 500 μm level, and black rust was slightly confirmed to the steel board side. Division B was 400 μm in the film thickness, and black rust was confirmed to the steel board side. Division C and D were 300 μm in the film thickness, and black rust was confirmed to the steel board side.

?Summary

As for this [a] tank, there was no coating for 17 years from construction, and BV resin GF coating was given in year 17. Afterwards, it is thought that the paint film was not repaired excluding the weld line. It is opened in 2008 recently, and the weld flakes off and is restored. There is no check result of the paint film when this opening it the paint film deterioration situation is thought to generate the paint film swelling before that when guessing from the level of the swelling and the rust seen in this investigation though is uncertain.

As for division C and D(300 μm), when the [i] film thickness is compared, the swellings are more remarkable than division A(500 μm) and B(400 μm) like the part where the film thickness which is small, and thin.

As for the film thickness, to expect the long-term durability for 30 years or more, 500 μm or more is guessed to be necessary from the state of the paint film of this tank though conditions of performance etc. of the coating of this [u] tank are uncertain.

Both impedance and adhesiveness [e] B, C, and D are hardly low, black rust is admitted in the broken flux line, and the corrosion prevention function of the paint film functions.

Address of thanks

When it undertook the main enumeration, I got special cooperation from Petroleum Association of Japan and the Petroleum Association of Japan joining enterprise. We wish to express our gratitude for recording.

5.4 Coating passage years in real tank and analysis of repair history

The data of the repair history at the time of each opening that lay a bottom coating etc. of the deterioration situation of the paint film in a real tank was collected, and the relation between the aged deterioration and the film thickness of the paint film was analyzed.

5.4.1 Collection of data

The repair history data at the time of each opening the coating of the tank of the following conditions was collected, the repair ratio of the coating to the tank bottom area at the time of each opening was requested from these data, and the relation between the number of years elapsed and the repair area ratio of the coating was investigated.

- ・Specific outdoor tank reservoir (10,000 kiloliters or more)
- ・The one to construct BV resin GF coating to tank bottom
- ・The one that is not warming tank
- ・The one that 20 years or more passed after constructing coating

The tank cardinal number where the repair ratios at the time of each opening were able to be collected was 39. Moreover, the one that the repair ratio when Kon would open it soon was able to be understood was seven. The relation to the repair ratio of the coating when the number of years elapsed for the coating and opening it is shown and the one that Figure 5.3.2 and the repair ratio of the coating at the time of each opening accumulated is shown in Figure 5.3.3.



図 5.3.2 タンクの経過年数と開放時の BV 樹脂 GF コーティングの補修割合



図 5.3.3 タンクの経過年数と開放時のBV樹脂GFコーティングの累積補修割合

A lot of things with a high repair rate come to be shown in Figure 5.3.2 when 20 years are exceeded though a red plot of Figure 5.3.2 and Figure 5.3.3 is BV resin GF coatings (Actual film thickness data is uncertain) constructed by the specification of minimum film thickness 250 μ m, and conditions of performance are also uncertain.

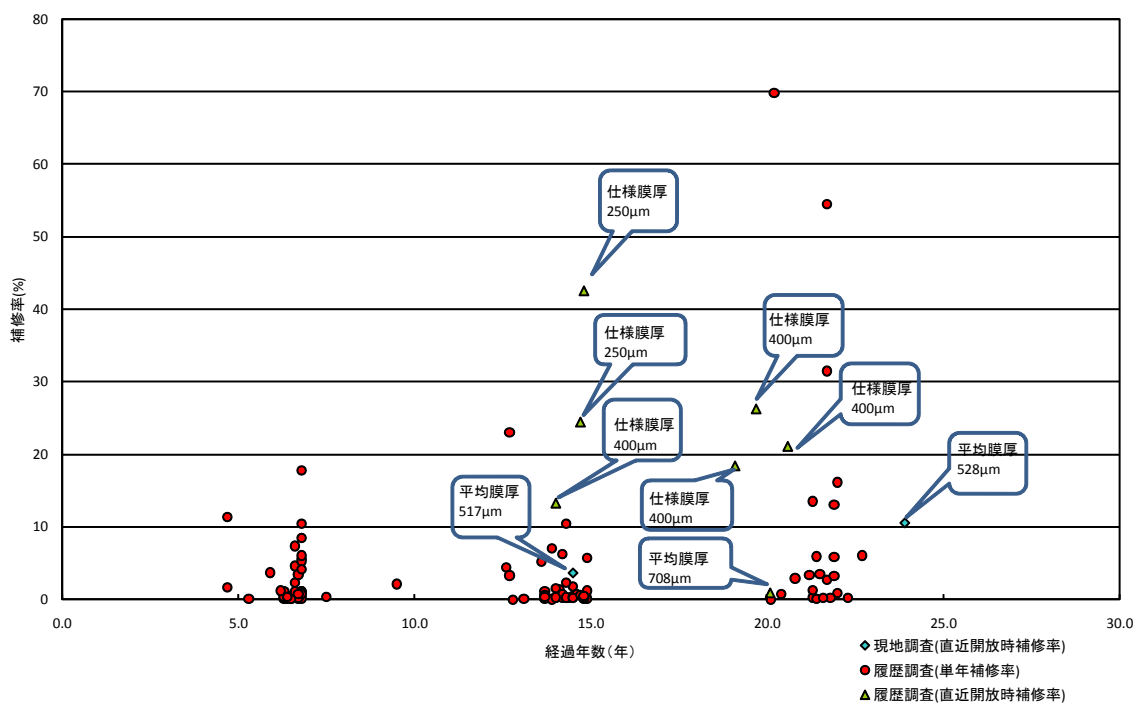
Address of thanks

When it undertook the main enumeration, I got special cooperation from Petroleum Association of Japan and the Petroleum Association of Japan joining enterprise. We wish to express our gratitude for recording.

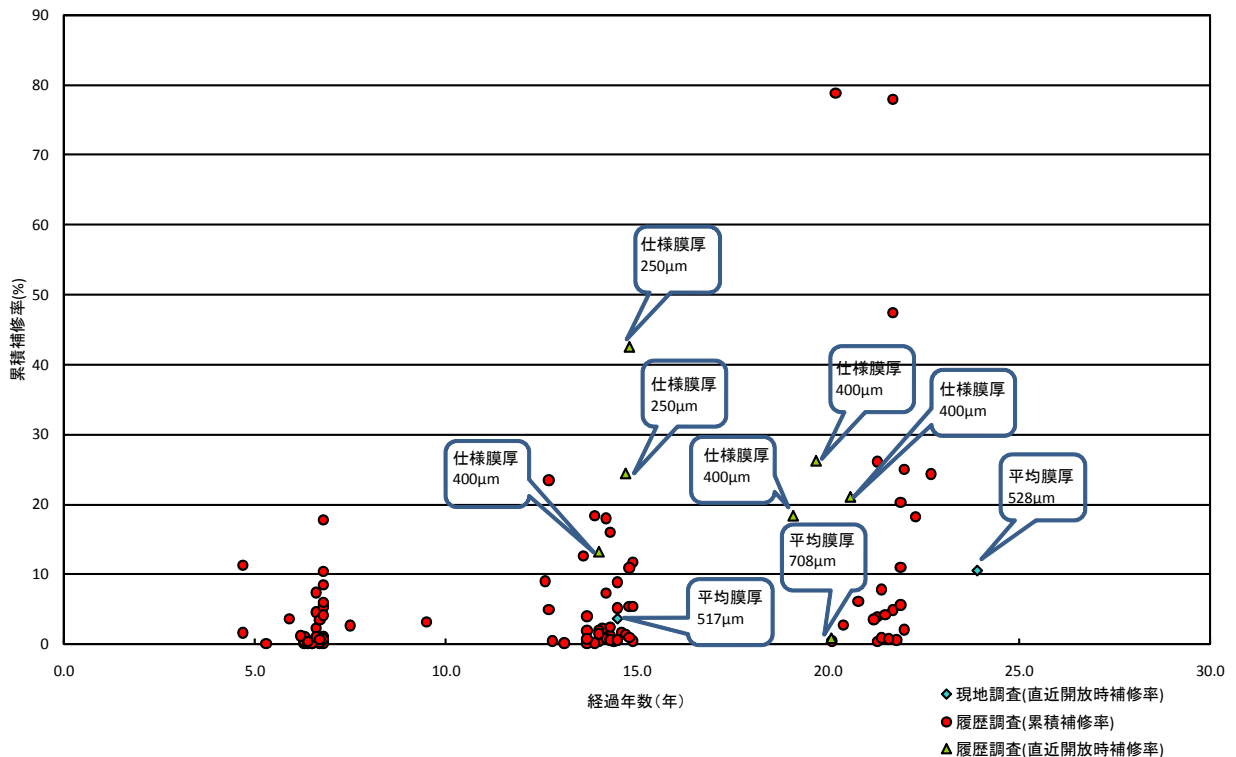
5.5 Inside corrosion of tank where coating was constructed This chapter analyzed the factor that inside corrosion of the case where inside corrosion progresses and the case that arrived at the accident progresses though was constructed the coating because it was thought that the corrosion rating's having greatly gone out though the coating was constructed to the tank bottom among inside corrosion of the tank bottom described by 2.4 related to the quality and the durability of the coating, and examined the method for the prevention of it.

5.5.1 Data analysis on inside corrosion of tank

About the tank where the GF coating is constructed, Figure 5.5.1 is an arrangement of the change in minimum board thickness due to inside corrosion in year of passage from the installation of the tank. These graphs are 2.4.1 It is what made by the idea described in "Investigation of actual conditions of the inside corrosion speed".



図 5.5.1 GF コーティングが施工されているタンクの内面腐食履歴の例

It is understood to provide a big as follows difference as an inside corrosion prevention function of the tank where the GF coating is constructed from Figure 5.5.1.

- Inside corrosion hardly progresses to the third times in the tank on the left.
- Inside corrosion progressed to the tank under the left since it opened the second though the inside corrosion prevention function was provided until the first opening it.
- An upper right tank constructs the GF coating when the first opening it, and inside corrosion doesn't progress after that.
- Inside corrosion progressed to a lower right tank since it opened the third though the inside corrosion prevention function was provided until the second opening it.

The presumption upper bound value is an inside corrosion speed (It is segment a inclination in the tank on the right Figure 5.5.1) that is assumed that the maximum, inside corrosion part of opening in the part that was the design board thickness after it repairs of opening last time this time was caused and requested though expresses from the next paragraph, that is, "Presumption upper bound value" and "Presumption lower

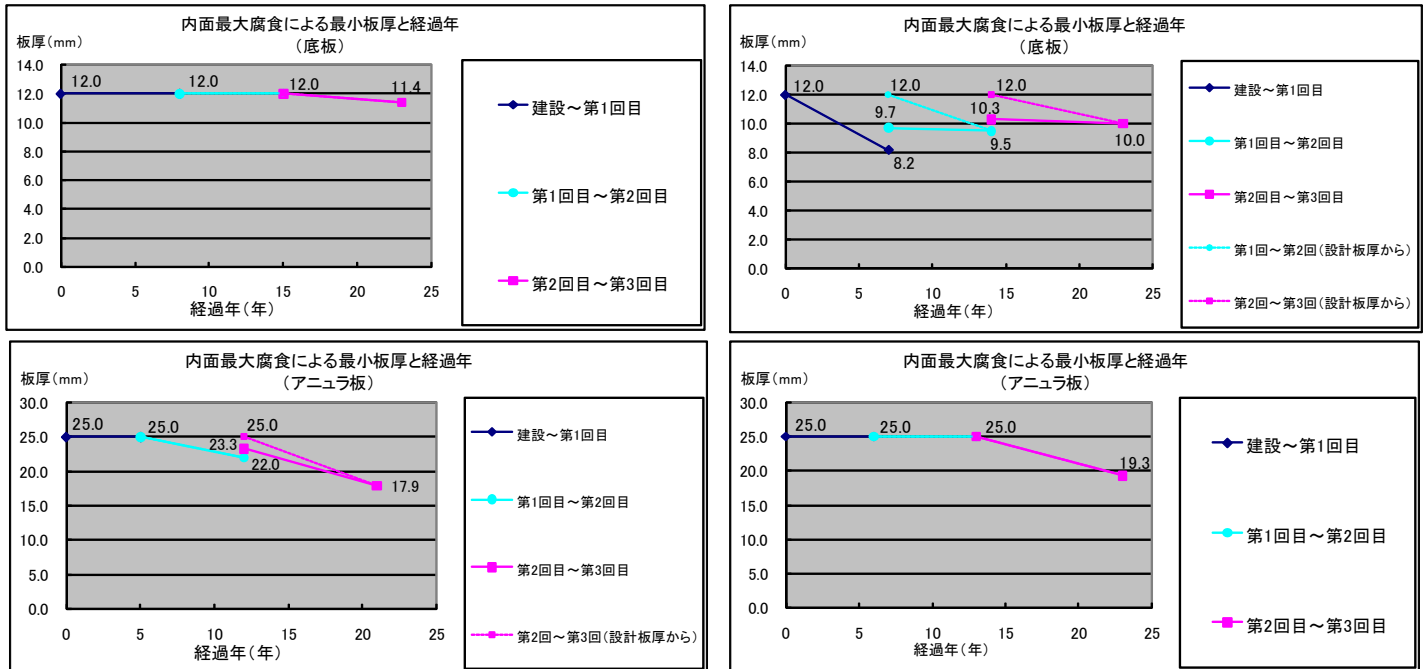
bound value" at the inside corrosion speed. The presumption lower bound value is an inside corrosion speed (It is segment b inclination in the tank on the right Figure 5.5.1) that is assumed that the maximum, inside corrosion part of opening in the part of the presumption minimum remainder board thickness after it repairs of opening last time this time was caused and requested.

The analysis of the inside corrosion prevention function due to the aged deterioration of the coating was executed from past inside corrosion history data. Figure 5.5.2(The presumption lower bound value at the inside corrosion speed; Figure 2.4.6 re-^[**]) and Figure 5.5.3(The presumption upper bound value at the inside corrosion speed; Figure 2.4.7 re-^[**]) are showing of the frequency distribution at the maximum, inside corrosion speed of each tank requested when the tank where the GF coating is constructed is opened each. A mean value and the maximum value were brought together in Table 5.5.1 and Table 5.5.2(Table 2.4.5 and Table 2.4.6 re-^[**])).

In the tank where the GF coating is constructed, there are the one constructed at first of construction and construction, no first construction of the coating, and the one constructed when opening is inspected. The GF coating is constructed at first of construction to do the aged deterioration of the coating in accuracy [yoku] [bunseki] as for the analyzed tank, and the one that there are results of three in the past open and repainting is not done has been extracted. It increases in the passing age, and a remarkable peak is not seen, and inside corrosion has been found in a lot of tanks the third times (passage of 22.8 years on the average from the coating construction) though the inside corrosion speed is seen from these figures in the mean value though there are a lot of one even of the second times (passage of 14.7 years on the average from the coating construction) whose inside corrosion is 0. The inside corrosion part discovered in the tank where the coating is constructed is caused in the part that causes abnormality such as the swellings in [ru] welding line neighborhood and the coating and flakes off for the repair, that coat inspecting it flakes off (Be restored afterwards). A determinate discussion is difficult because the location of occurrence of inside corrosion is not recorded, and the possibility that a lot of inside corrosion has been found because the part where the coating flaked off by some factors increased to the third times is thought. The one constructed by the coating indicator and the one not constructed are included in these tanks.



図 5.5.2 建設当初からGFコーティングが施工されているタンクの開放ごとの内面腐食速度の推定下限値

表 5.5.1 内面腐食速度の推定下限値の平均値、最大値の開放ごとの変化及び対象タンク数

部位		第1回開放	第2回開放	第3回開放
アニュラ板	腐食速度の平均値 (mm/年)	0.019	0.041	0.174
	腐食速度の最大値 (mm/年)	0.357	0.429	1.01
	タンク基数	93	93	93
底板	腐食速度の平均値 (mm/年)	0.033	0.047	0.154
	腐食速度の最大値 (mm/年)	0.657	0.367	0.544
	タンク基数	71	71	71

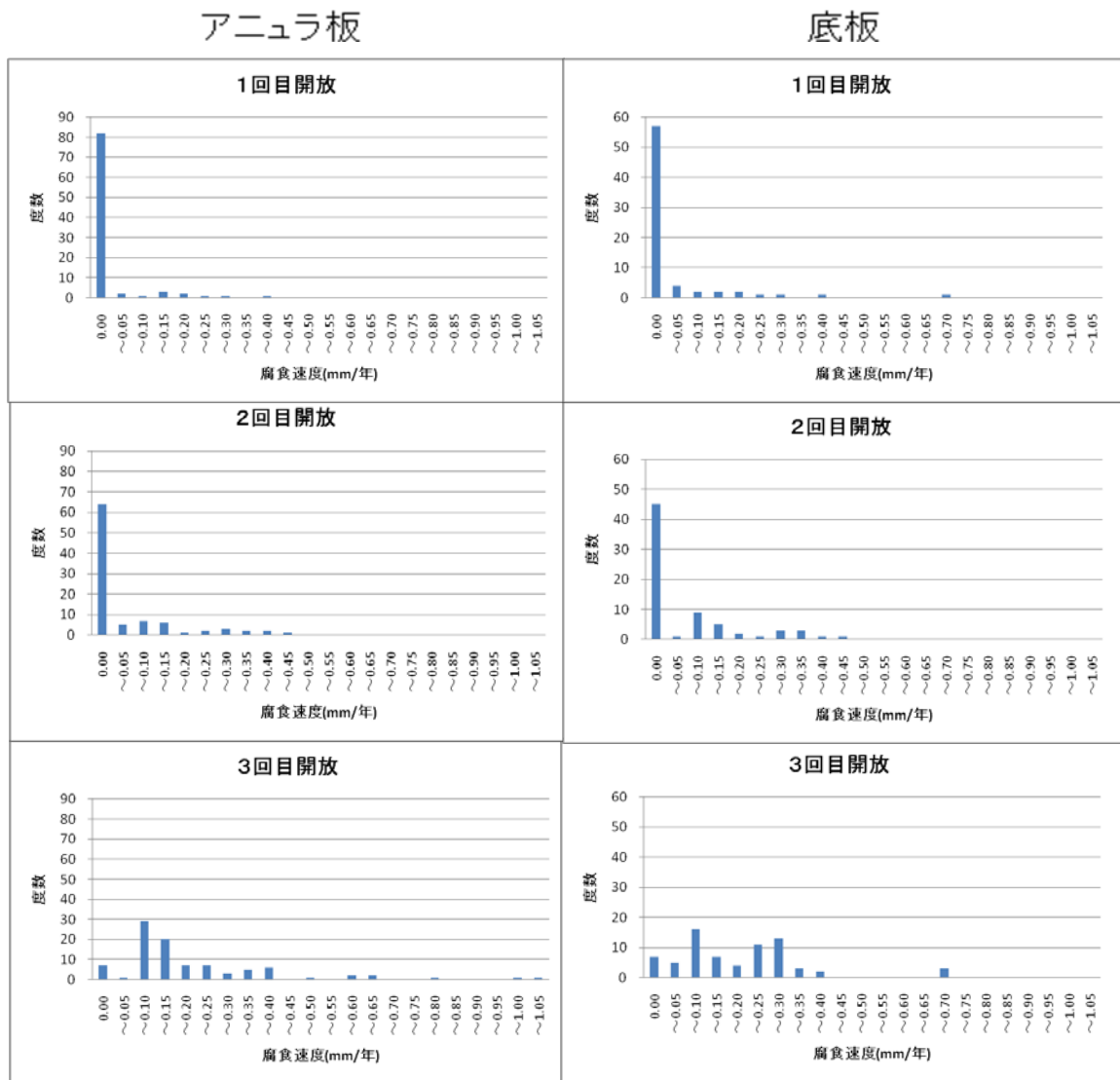

図 5.5.3 建設当初からGFコーティングが施工されているタンクの
開放ごとの内面腐食速度の推定上限値

表 5.5.2 内面腐食速度の推定上限値の平均値、最大値の開放ごとの変化及び対象タンク数

部位		第1回開放	第2回開放	第3回開放
アニュラ板	腐食速度の平均値 (mm/年)	0.019	0.049	0.198
	腐食速度の最大値 (mm/年)	0.357	0.429	1.2
	タンク基数	93	93	93
底板	腐食速度の平均値 (mm/年)	0.033	0.063	0.185
	腐食速度の最大値 (mm/年)	0.657	0.479	0.7
	タンク基数	71	71	71

5.5.2 Collection and analysis of trouble case with tank where coating is constructed

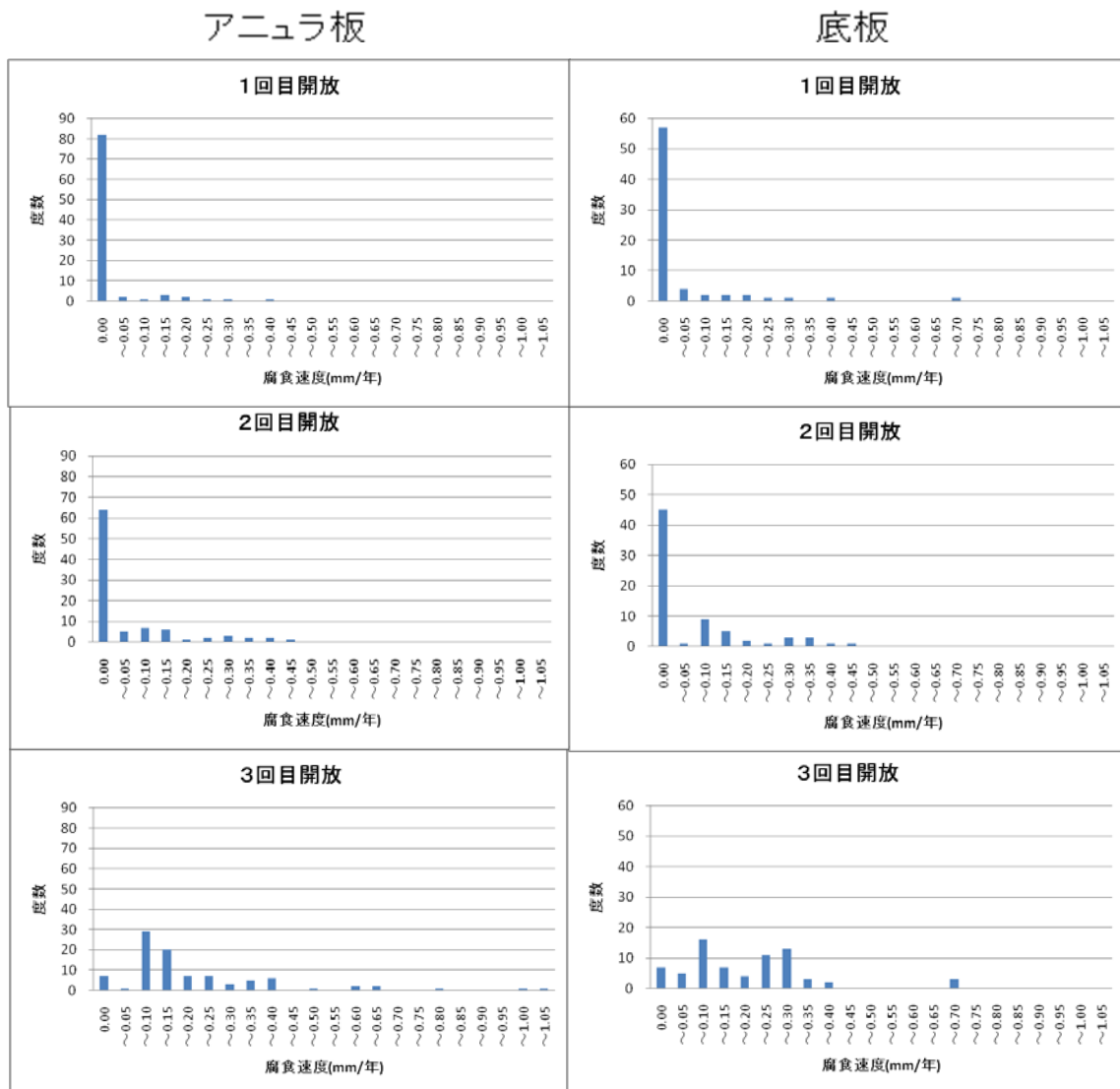
It reports on the coating and the tank where inside corrosion is caused though it is reported though the corrosion rating between the lives of the coating is expected to become 0 as for the tank where the coating is constructed. 1 that collects investigation reports etc. and analyzes case where trouble like the one etc. with inside corrosion though coating was constructed to examine factor that inside corrosion prevention function is not demonstrated is caused) ?4)A lot of things that the survey analysis etc. of the cause are untried even if such trouble is found exist. The part where each case [nakashitasen] is pulled is referred in (5).



(1)Accident case?Accident case 90

·Contents: Crude oil·[Anyura] board: Tar

epoxy resin (Paint it the piling before nine years accidents) epoxy resin (Before 15 years accidents) and coating and bottom plate: The tar epoxy resin (Nine years the accident ago) coating. ·Design film thickness: 200µm and real film thickness: 120µm?1500µm

·Shape in opening (photograph on the right)

·Open mouth place: Three places (2 and southwest 1 for the south). Bottom plate of 10m from shroud roughly (9mm). ·A doughnut subsidence was large, and it was at a low position the surrounding of the corrosion part. ·The coating flaking off was seen in the part where foundation had been adjusted with two-kind [keren] (accident tank and adjacent tank). It is possible that the hydrogen sulfide promoted deterioration and flaking off of the coating. ·The sulfide existed. ·The factor that became a high corrosion rating is thought to be existence of anaerobic sulfate reduction bacteria. ·It is not easy to think the factor that only having increased the corrosion rating by having caused flaking off of a part of the coating promoted the pitting corrosion. ·Table 5.5.3 shows the drain water of the accident tank and the analysis result of the sludge.

表 5.5.3 事故タンクボトムドレン及びスラッジ分析結果

	No. 47 TANK	No. 43 TANK
ボトムドレン	(I. L系)	(M. SULFUR系)
PH	3. 2	6. 9
NACL	4 4 7 6 PPM	3 1 9 4 2 PPM
CL	2 7 1 6 PPM	1 9 3 8 1 PPM
SO4	4 1 3 PPM	1 0 PPM
CO3	同定困難	同定困難
H2S	Ni 1	Ni 1
RSH	3 PPM	3 PPM
	以下	以下
ボトムスラッジ		
R, PH	4. 2	7. 9
NACL	7 0 PPM	3 0 8 6 PPM
CL	4 3 PPM	1 8 7 2 PPM

- No.47 is a tank where accident tank and No.43 are similar to the accident

?Accident case 106

・Contents: Crude oil・The tar epoxy resin coating (Construct it before 12 years accidents).

・Design film thickness 200 μ m and real film thickness 120 μ m?1500 μ m。

・A lot of pinholes and impurities are found. ・Shape in opening (right photograph)・Open mouth place: [Anyura] board right under [doreinnozuru] (12mm)・It was likely not to have been able to inspect it the workability and afterwards because it was [doreinnozuru] right under.

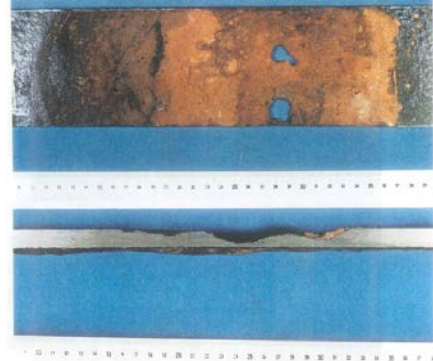

・There is a possibility to be exposed directly to oil that exceeds 60°C. ・There are flow velocity at the acceptance and a possibility of wear-out by the sludge rolling. ・It is presumed the mixture effect of corrosion with corrosion with the oxygen concentration cell with the sludge piling up situation, corrosion with the macro cell in the coating flaking off part, and the acid as a generation factor of a high corrosion ratio. ・Table 5.5.4 shows the analysis of the ion chromatography of the sample of the tank bottom board, the sludge, and the drain water result, the titration analysis result, and the PH result of a measurement.

表 5.5.4 底板のサンプル、スラッジ、ドレン水の分析結果

試料		F	Cl	NO ₂	NO ₃	NH ₄	SO ₄	PO ₄	Na	Ca	*SiO ₂	**CO ₃	***HCO ₃	***pH
腐食面スケール	① 水切り部 1 (北 欠明き)	3	37	<1	<1	4	1,700	<1	99	890	190	-(注)	-(注)	7.4
	② 水切り部 2 (南東)	<1	5,500	<1	<1	41	2,900	<1	27	2,700	240	-(注)	-(注)	5.3
	③ 水切り部 3 (南西)	13	6,600	<1	<1	42	2,400	<1	470	2,400	230	-(注)	-(注)	5.1
	④ ｽｰﾌﾟﾍﾞｰｼﾞﾝﾄﾞ	4	1,600	<1	15	4	720	<1	44	1,300	100	-(注)	-(注)	6.9
	⑤ 腐食部	<1	3,800	<1	<1	41	630	<1	540	1,200	31	-(注)	-(注)	5.5
スラッジ	2-2 洗浄済 原油ヘドロ状	1	830	7	51	11	430	<1	480	300	43	<10	140	6.6
	1A 水切り1の 廻り	2	220	11	54	7	430	<1	260	200	36	<10	160	6.9
	1B 水切り1の 内部	3	150	14	60	15	740	<1	310	270	46	<10	140	6.9
	2A 水切り2の 廻り	4	280	7	55	13	1,400	<1	310	660	63	<10	330	7.1
	3A 水切り3の 廻り	2	250	9	49	8	430	<1	290	230	44	<10	200	6.9
	7 ｽｰﾌﾟﾍﾞｰｼﾞﾝﾄﾞ	<1	8,800	8	47	110	440	<1	580	1,300	27	<10	<10	4.4
	ドレン	ドレン	<1	4,600	<1	<1	20	26	<1	2,200	460	12	40	99

* ; I C P 発光分光分析法
 ** ; 滴定法
 *** ; ガラス電極法にて1%溶液を測定
 (注) ; 前処理による加温で大きく変動 (減少) するため実施せず。

?Accident case 117

・Contents: Crude oil・It repairs by the flakes coating the FRP lining construction and 18

years ago before 24 years accidents. ·Real film thickness: 100 μ m?1000 μ m.
 ·A lot of pinholes. Partially, it misses and it exists about the primer. The possibility that salinity exists under the paint film in part is high. ·Shape in opening (right photograph)·Open mouth place: [Anyura] board right under [doreinnozuru] (12mm)·It was likely not to have been able to inspect it the workability and afterwards because it was [doreinnozuru] right under. ·There is a possibility to be exposed directly to oil that exceeds 60°C. ·There are flow velocity at the acceptance and a possibility of wear-out by the sludge rolling. ·The part constructed without the primer flakes off, and corrosion occurs under the paint film because of use afterwards, the factor in which the deterioration flaking off of the paint film like the [suroppu] oil keep insertion etc. is promoted comes in succession, and the paint film flakes off partially. ·The existence of the chlorine ion and the sulphuric acid ion is thought as a generation factor of a high corrosion rating. ·Table 5.5.5 shows the analysis of the ion chromatography of the sample of the tank bottom board, the sludge, and the drain water result, the titration analysis result, and the PH result of a measurement.

表 5.5.5 底板のサンプル、スラッジ、ドレン水の分析結果

【試料調整方法】

スケール：試料に純水を加え 1 w/o とし、熱板上で約 80°C にて沸騰しないように加温、液量が約 1/2 になるまで濃縮する

→放冷後、ろ過し、純水を用いて残滓のスケールとろ紙を十分洗浄する。

→純水で希釈し 1 w/o 溶液とする。この溶液を用いて分析する。

下記結果は元試料濃度に換算。

スラッジ：試料に純水を加え 1 w/o とし、常温にて 6Hr 振とう溶出。この溶液を用いて分析する。

下記結果は元試料濃度に換算。

ドレン：混入している油を除去後、直接分析する。

試料			F	Cl	NO ₂	NO ₃	NH ₄	SO ₄	PO ₄	Na	Ca	*SiO ₂	**CO ₂	**HCO ₃	***pH
スケール	SA1	水切り部1 (南 穴あき)	7.4	2,960	< 0.01	14.7	10.8	1,150	< 0.01	61.4	1,990	306	—(注)	—(注)	4.5
	SA2	水切り部2 (南東)	2.2	5,600	< 0.01	< 0.01	34.9	419	< 0.01	396	2,620	88.3	—(注)	—(注)	4.7
スラッジ 1A	原油ヘッドロ状		< 0.01	1,400	< 0.01	< 0.01	0.66	2	< 0.01	7.01	1.50	0.17	<0.001	6.45	6.4
ドレン	ドレン		0.74	22,600	< 0.01	< 0.01	0.25	48	< 0.01	9.65	2.38	21.0	0.31	216	7.5

* : ICP 発光分光分析法

** : 滴定法

*** : ガラス電極法にて 1% 溶液を測定

(注) ; 前処理による加温で大きく変動 (減少) するため実施せず。

?Accident case 133

·Contents: Heavy naphtha·Vinyl ester resin coating (construction before nine years accidents). ·Design film thickness: 500 μ m

・..coating flaking off part.. one (pit initiation) besides opening. ・Shape in opening (right photograph) ・Open mouth place: Bottom plate under anode for electrolytic protection (6mm). ・ There were the lower side of the anode and only 30mm space in the bottom plate, and the groundwork processing was not able to be done enough. It is clear that there was defective



construction. ・The chloride ion, the sulfide ion, and the organic acid were in a high density detected in the drain water. ・The coating flaked off in the construction defect part of the coating. ・In the drain water on the surface of the steel board of the coating flaking off part, the dissolved oxygen and the local cell with the organic acid etc. were formed, and electrochemical corrosion was caused. ・The progress of corrosion was promoted with the chloride and the sulfide, etc. in the drain water. ・Table 5.5.6 shows the physical properties analysis data of the drain water.

Nidekinakatta]. It is clear that there was defective construction. ・The chloride ion, the sulfide ion, and the organic acid were in a high density detected in the drain water. ・ The coating flaked off in the construction defect part of the coating. ・In the drain water on the surface of the steel board of the coating flaking off part, the dissolved oxygen and the local cell with the organic acid etc. were formed, and electrochemical corrosion was caused. ・The progress of corrosion was promoted with the chloride and the sulfide, etc. in the drain water. ・Table 5.5.6 shows the physical properties analysis data of the drain water.

表 5.5.6 ドレン水の分析結果

	10/10 15:00	10/16 9:15	10/21 9:15	
PH	6.81	6.66	6.53	
電気伝導率	22.5	22.5	23.6	
鉄	0.6	0.6	0.8	
溶解性鉄	1	2.8	1	
塩化物イオン	11	14	9	
硫酸イオン	8	2	1	
硫化物	29	23	18	
炭酸	16未満	16未満	16未満	
亜硝酸イオン	1未満	2	1未満	
全酸	16.8	17.6	22.9	18.6
ギ酸	1未満	10未満	10未満	
プロピオン酸	1未満	10未満	10未満	
酢酸	1.7	1.4	1.9	
MEA	5未満	5未満	5未満	
MIPA	14.0	14.0	16.0	
DMEA	10未満	10未満	10未満	
アンモニア	0.9	1.4	0.8	

(2) Inside corrosion generation case with tank where GF coating was constructed? Inside corrosion generation case 1

・Tank volume: 14,505-kiloliter floatage roof type・Tank completion year: 1979・Contents: Crude oil・There is no heating equipment (Remove it in 2001). ・History of open: 2010 2001 1993 1986・Coating history: Trying construction in 1986 and all aspects of 1993 paint・Design film thickness: 350 μ m

・When opening it in 2010, flaking off and inside corrosion of the coating were found. A lot of flaking off parts of the coating exist though Figure 5.5.4 is a coating visual inspection record when the tank is opened. The photograph is showing of the flaking off situation. ・Figure 5.5.5 is an inside corrosion check of bottom board record. It occurs on the [anyura] board and inside corrosion of 6.9mm or less occurs in 3.5mm and the bottom plates. When opening it in 2001, inside corrosion of 1.8mm or more is repaired. ・The meat vigor repair is executed at the time of each opening, and this tank is thought that the corrosion prevention function of the coating was low. ・Paints with low heat resistance performance were used. ・The erosive environment is severe because of the influence of contents (high aroma and temperature).



図 5.5.4 コーティング目視検査記録

No	欠陥種別	発生部位	Depth (mm)
1	ピッチング	アニュラプレート	3.5
2	ピッチング	底板	3.0
3	ピッチング	底板	3.1
4	ピッチング	底板	5.7
5	ピッチング	底板	3.9
6	ピッチング	底板	6.9
7	ピッチング	底板	3.5
8	ピッチング	底板	4.8
9	ピッチング	底板	3.7
10	ピッチング	底板	3.2
11	ピッチング	底板	2.6
12	ピッチング	底板	2.4
13	ピッチング	底板	2.8
14	ピッチング	底板	2.5
15	ピッチング	底板	3.9
16	ピッチング	底板	2.8
17	ピッチング	底板	6.0
18	ピッチング	底板	3.0
19	ピッチング	底板	2.6

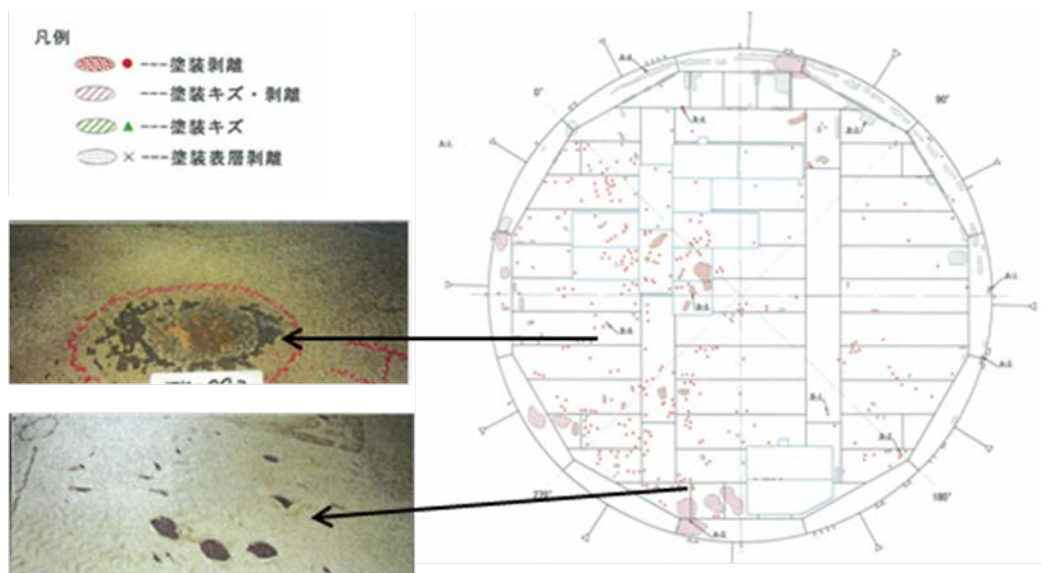

図 5.5.5 底部内面腐食目視検査記録

?Inside corrosion generation case 2

・Tank volume: 38,858-kiloliter floatage roof type・Tank completion year: 1991・Contents: Naphtha・There is no heating equipment. ・History of open: (2007 1998)・Coating history: 1991(Set it up)(use for 16 years). ・Design film thickness: 350 μ m

・Inside corrosion did not occur though it swelled, and flaking off was seen in a part of the [anyura] board when 1998 year was opened (The coating was used for seven years). ・It was a partial swelling in the [anyura] board and the bottom plate at time of open of 2007, and flaking off and [kizu] were confirmed, and it was 4.8mm in the [anyura] board, and inside corrosion of 6.3mm was found in the bottom plate. ・The part of 190 μ m was confirmed to design film thickness 350 μ m by the actual measurement value. ・In the quality identification of the coating in front of the oil Inn, the pinhole test is untried. (It was not confirmed that there was no [kizu] in the coating.)

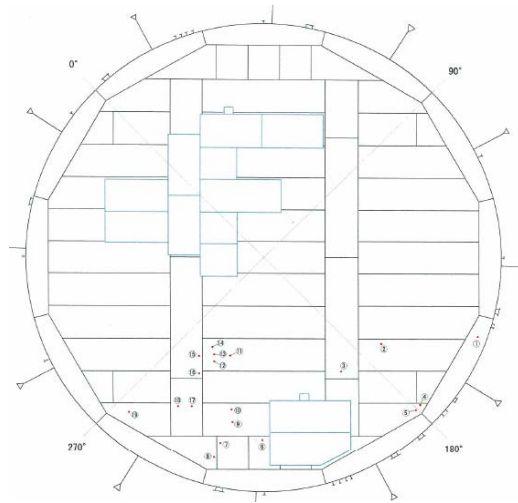
?Inside corrosion generation case 3

・Tank volume: 65,700-kiloliter floatage roof type・Tank completion year: 1979・Contents: Crude oil・There is heating equipment. ・History of open (2008 1999 1991 1985)・Coating history: Construction in 1985 (use for 23 years)・Design film thickness: 350 μ m

・Inside corrosion of 5.3mm occurred in the bottom plate at time of open of 2008. ・Inside corrosion occurred when the 1st was opened because it had not constructed the coating when constructing it, and the one of less than 3.5mm did not execute the meat vigor repair in that case and the coating was constructed. It is thought that it enters the state to accumulate moisture easily from the execution of the meat vigor repair and the existence of the dent after groundwork processing shortage and the coating are

constructed of the becoming it part and the swelling was generated. ·Paints with low resistance to solvent attack are used.

(3)Steel board corrosion situation under swelling of GF coating?Investigation case 1

·Tank volume: 59,600-kiloliter floatage roof type·Tank completion year: 2003·Contents: Crude oil·Management temperature: 70°C

·History of open: (2009)·Coating history: 2003(Complete it)(use for six years). ·Design film thickness: 560 μ m

·The [anyura] board and the swelling was both generated in the bottom plate over all aspects and flaking off was found partially at time of open of 2009. The size of the swelling is divided into the one of ϕ 10?100mm and the one of less than ϕ 10mm, and the latter is generated in the former in the layer of intermediate coat between foundation and the primer. (Refer to the situation of the occurrence of the swelling to the photograph under the left.)·The film thickness was more than a regulated value. Salinity is detected from the swollen paint film under, and the swelling between foundation/primer is thought the influence of the salinity that remains on the steel board side. The electrical property was also deteriorated, and the swelling in the intermediate coat layer was the one that dissolved with the swelling and the penetrating solvent (aroma) the polystyrene in the paint film and became a swelling and this was accelerated by the temperature. ·Flaking off is presumed to be the one by a rapid cooling the paint film when opening it. ·It had not arrived at plain thinning though black rust was seen in the steel board under the swelling part of the paint film (Refer to the situation of the steel board under the swelling to the photograph under the right).

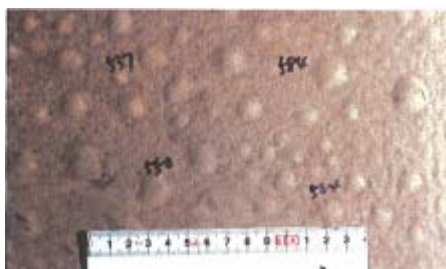

アニュラ部のふくれ集中箇所ふくれの大きさは ϕ 5~20mm、周辺の膜厚は550 μ m程度



ふくれの下の鋼板には黒さびが発生しているが激しい減肉はない。

?Investigation case 2

• Tank volume: 35,000-kiloliter floatage roof type
• Tank completion year: 1979 • Contents: Crude petroleum and crude oil
• Management temperature: 55°C (A heatproof coating is constructed).

• History of open: (2009) • Coating history: 1998 (use for ten years)

• Design film thickness: 700 μm

• The swelling had been generated in about 2/3 in the bottom plate at time of open of 2008 (Refer to the situation of the swelling to a right photograph). The size of the swelling had been generated by $\Phi 10 \times 25\text{mm}$ in [chuunusou]. Figure 5.5.6 is showing of the range of the swelling generation (The range that colored to the black is a part of ..swelling.. generation). • Corrosion was not caused on the steel board. • The film thickness was more than a regulated value. Abnormality was not found in the adhesion power. • The cause of generation of the swelling was presumed assuming that it depended on moisture's in surroundings of ventilation shortage and the heating coil when intermediate coat was painted being warmed, and having generated the pool ball of the high temperature.



図 5.5.6 コーティングの膨れ発生範囲

(4) Repair history of tank where GF coating was constructed (reference ?10)

Figure 5.5.7 is 5 that is the one that the repair rate to the bottom area at the time of each opening the GF coating in the savings tank in the national savings base accumulated at the time of each opening.)Because the repair targets the part where the swelling was caused, it can be thought the ratio to the bottom area of the area where the swelling is generated. Green data (The coating specification: average film thickness 650 μm and minimum film thickness 430 μm) is a tank in the base constructed before about ten years showing the coating indicator, and the data of the orange (The coating specification: average film thickness 560 μm and minimum film thickness 400 μm) is a tank in the base constructed before about two years showing the coating indicator. It is constructed by GF paints and the film thickness that the tank in each base is provided for by the coating indicator.

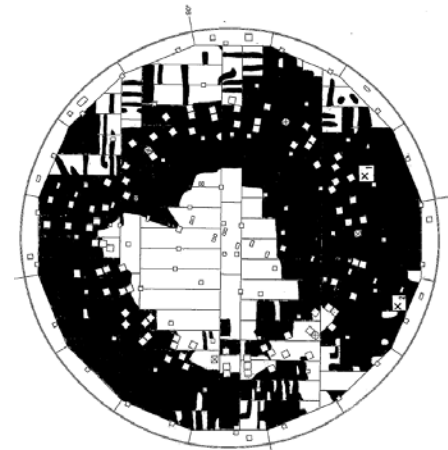

図 5.5.7 タンク経過年とGFコーティングの累積補修率

There is something where the swelling has been generated at a big area rate since considerably early time (18) Figure 5.5.7 is seeing all tanks. It is done according to removal shortage and defective construction (dewfall) of the inorganic zinc shop primer when studying into the cause about these. It is thought that removal shortage was caused because the influence that the inorganic zinc shop primer has on the coating quality was not clear when these coatings are constructed though the former is confirmed by 14.

Afterwards..influence..clarified..coating..indicator..division..foundation..adjustment..confirmation..such..defective..cause.The confirmation is not done in the construction record (record at each [nurushime]) though defective construction (dewfall) is doubted by four by the one analogized from the weather on that day of construction etc.

It is a repair rate though Figure 5.5.8 excluded a defective tank for construction due to inorganic zinc shop primer removal shortage from Figure 5.5.7. It is a tank where defective construction (dewfall) is doubted though the data of - is not confirmed. If defective construction is excluded, it is understood the swelling is hardly generated in a lot of tanks. Especially, the repair history of the data of the base that is the content of construction equal with the coating indicator (orange) is small.

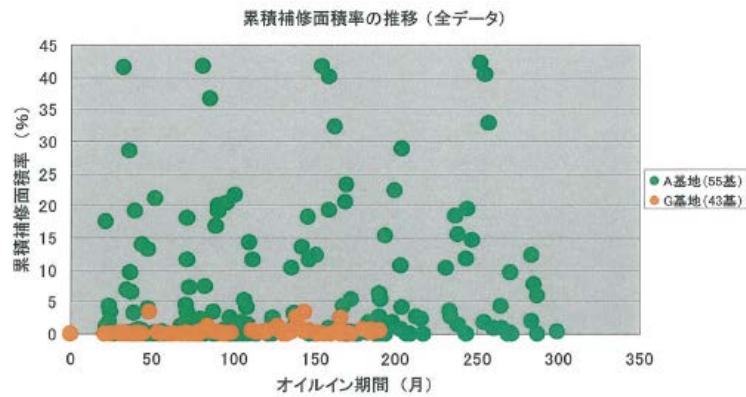
Most corrosion is not caused in the parent metal under the paint film in the coating where the swelling has been hardly



図 5.5.8 タンク経過年とGFコーティングの累積補修率 (施工不良タンク除く)

generated. As for the GF coating that follows the coating indicator from the above-mentioned, it is understood that the inside corrosion prevention function is high. (reference)Figure 5.5.9 is 6 that is the result that a similar investigation was done in 1996.)There is the one that the swelling has been hardly generated, too and it is understood that the difference is large in an old coating at the construction age the anticorrosive effect of the paint film though there are a lot of one that the swelling was generated. A private object tank is the main, and paints are contained excluding the GF coating.

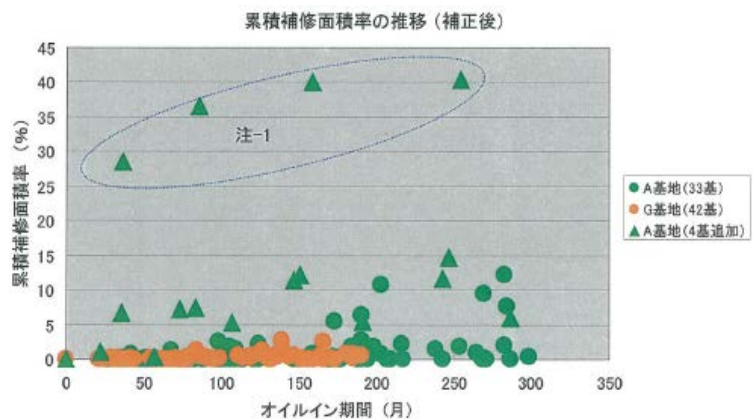
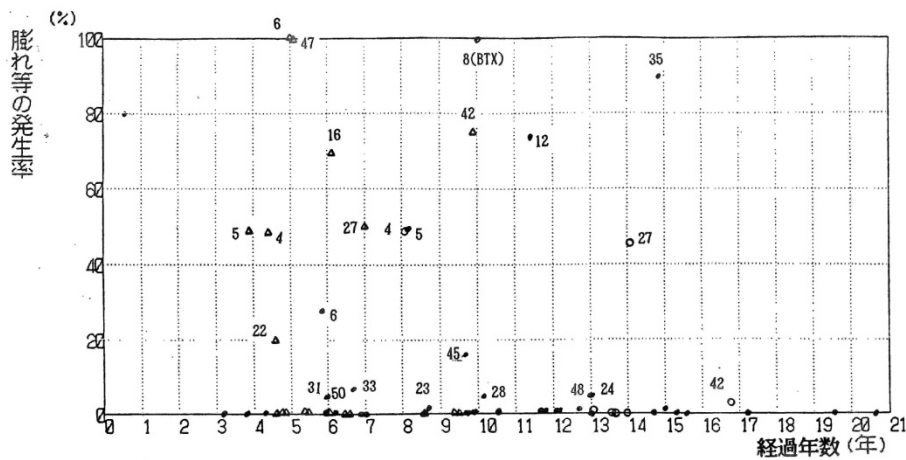

(注1)・：初期塗膜、○：補強塗膜、△：溶接線の補修塗膜
(注2)補強塗膜の年数は、塗り重ね塗膜下の旧塗膜の経過年数
図4-1 膨れ等の発生率と塗膜の経過年数との関係

図 5. 5. 9 民間タンクのタンク経過年とコーティングの膨れ発生率

(5)Summary of trouble case with coating

(1)?(4)The following can be said by drinking and bringing result [wo] together.

?When the coating flakes off in the tank where the coating was constructed, the corrosion rating might become large.

?The factor that the coating flakes off includes the following one.

- ・Use of paints with low resistance to solvent attack
- ・Dewfall on surface of painting and adhesion power shortage because of return rust
- ・Coating degradation by high temperature
- ・Adhesion power shortage and corrosion progress by the groundwork defective processing (remaining and surface-roughness shortage of salinity and garbage)

- ・Film thickness shortage and stiffening shortage because of defective construction

?The factor that the steel board receives the severe corrosion after it flakes off is as follows. ・Formation of macro cell・Formation of oxygen concentration cell・Action of

sulfate reduction bacteria and corrosion with acid etc.?Thinning [shitamono] is not plainly found though corrosion such as black rust is found as the swelling under is a little. It is understood that intense inside corrosion doesn't occur as long as the coating doesn't flake off from this.

It is received to have caused the problem such as flaking off of the paint film in the coating constructed in the 1975's, is done the examination of the material quality and conditions of performance of the coating in the 1985's, and a conclusion almost similar to the above-mentioned analysis is obtained. The requirement for the coating that did not flake off easily was brought together as a result of the examination, and "Coating indicator (fire fighting [abuna] No.74 in 1994)" was made. It is thought that trouble by a factor already-known of these is not caused if constructed in accordance with the coating indicator. The underlined part in the accident case with (1) is a factor that can be excluded if constructed in accordance with the coating indicator.

References cited

- 1)Hazardous Materials Safety Techniques Association: November, investigation society report and 1997 concerning bottom corrosion of coating tank
- 2)Hazardous Materials Safety Techniques Association: November, investigation advisory committee report and 2001 concerning cause of crude oil leakage accident from outdoor tank reservoir
- 3)O oil factory of S Ltd. accident measures special committee: O oil factory June 17, tank separation of 003 # crude oil water leakage accident report and 2003
- 4)K oil factory of T Ltd.: September, No.19 tank oil leakage accident cause investigation report book and 2006
- 5)Japanese high-pressure power technological society: Durability study (investigation of results of coating) January, report and 2010 of tank bottom coating of land tank in 2009 fiscal year
- 6)Hazardous Materials Safety Techniques Association: March, investigation examination report and 1997 concerning coating in outdoor storage tank

5.6 Thermal gradient soak examination tank paint film investigation bring together temperature inclination soak examination tank coating degradation correlation report thermal gradient soak examination test piece paint film defect generate days the test piece equal paint film tank defect generate years correlation show assuming that working curve with durability limit examine. As a result, it was thought that it was an effective means to forecast a long-term durability limit even if it was a paint film without the use results in a real tank from the temperature inclination soaking examination result. The paint film of 40/20 °C temperature inclination soaking examination and a real tank was investigated aiming to make the working curve in the normal temperature use for the GF coating paint film by using a past result of review etc. and supplementing data with the experiment etc. at current year.

The relation between the influence and the film thickness that the moisture element exerted on the swelling of the paint film was chiefly done and it examined it because the swelling appeared a lot as an aged deterioration of the paint film of the tank, and the one that influenced a lot as a cause of the swelling was thought to be a moisture element as the realities though it swelled as a kind of the defect that judged the durability limit of the paint film, and there were a swelling and a resolution.

It is clearer that it is not the one that the corrosion wastage progresses to the tank bottom board at once than a site investigation at current year and a past result of review even if the swelling is generated in the paint film, and when the swelling tears in one side, the corrosion rating might become large depending on the environmental condition like the deterioration situation etc. of the paint film in the surrounding. The swelling tore in a present finding at the time of which extent after having generated the swelling, and it paid attention to the generation of the swelling because it was not clear and it examined whether to flake off.

5.6.2 Swelling generated in paint film of tank

It is thought that the situation of the occurrence of the swelling generated in the paint film of the tank can be modeled in the breakdown generation curve like Figure 5.6.1. It is thought that it begins to swell by the incipient defect by the selection mistake etc. of defective construction and the paints material at early time after the coating is constructed (Figure 5.6.1). It is thought that the trouble case investigated by 5.5 corresponds as such an example. Next, Figure 5.6.1 though it is a swelling due to the defect of happening by accident (Defect according to a reasonable execution management by a difficult factor to exclude) to appear, and was performed a constant

execution management. It is generated at the period when [ni] corresponds. It is thought that the swelling has generated in three tanks where the locale was surveyed in 2009 fiscal year corresponds to this example. There were a lot of small one of the repair rate as for the repair rate of the paint film at the time of each opening when the 4th was opened small (passage years about 26 years)(Table 5.6.1) though the swelling had been generated in these tanks at the time of each opening. Finally, the swelling by passing the durability limit of the paint film is generated (Figure 5.6.1). As such an example, both the impedance measurements and the adhesion power measurements local investigation C tanks of current year are generated by about 11% when the defect such as the swellings opens it this time, and lower, and a paint film concerned cannot say that the inside corrosion prevention function will be maintained, and is thought to have generated the swelling by the durability limit of the paint film from the occurrence of the corrosion of the bottom such as flaking off of the paint film.



図 5.6.1 塗膜の膨れ等の欠陥発生率と経過年のイメージ図

表 5.6.1 平均膜厚 700 μm 程度のタンクの経過年と補修率の関係

タンク No.	A-4	A-8	A-9	A-10	A-13	A-14	A-15	A-16	A-17	
新規塗装	初期膜厚 (Min) μm	440	450	470	480	500	500	450	450	450
	初期膜厚 (Ave) μm	825	789	781	731	821	756	853	785	791
	初期塗装完了	82/11/18	83/05/20	82/12/09	83/05/19	83/10/17	83/10/17	83/10/20	83/10/20	83/10/29
1回目開放	第1回オイルイン 年月	83/09/22	83/09/23	83/10/17	83/10/17	83/11/01	83/11/10	83/11/09	83/11/08	84/02/02
	第1回目開放 年月	86/08/29	86/09/23	85/08/06	85/07/09	86/05/18	86/11/24	88/07/18	87/07/18	88/05/06
	膨れ・剥離面積 (m^2)	0	0.25	50	0	1	0.5	1.5	1.2	5
	補修面積 (m^2)	5	0.25	50	0	1	0.5	1.5	1.2	5
2回目開放	第2回目開放 年月	91/09/16	91/10/03	91/08/29	90/05/10	90/09/22	92/09/21	93/06/30	92/11/04	93/07/13
	2回目開放時の経過年数	8.0	8.0	7.9	6.6	6.9	8.9	9.6	9.0	9.4
	膨れ面積 (m^2)	0.7	12	242	4	1	0	6	0	13
	補修率 (%)	0.01	0.26	6.26	0.09	0.02	0.00	0.13	0.00	0.28
3回目開放	第3回目開放 年月	1998/5/19	98/07/31	1998/6/23	96/07/06	97/06/27	99/08/18	00/07/28	1999/10/25	00/09/26
	3回目開放時の経過年数	15	15	15	13	14	16	17	16	17
	膨れ面積 (m^2)	2.2	26	196	82	0.04	0	77	1.3	54
	補修率 (%)	0.05	0.55	4.17	2.09	0.00	0.00	1.64	0.03	1.15
4回目開放	第4回目開放 年月	2006/9/1	2007/7/5	2006/10/1	2004/12/1	2005/4/1	2008/4/1	2009/5/1	2008/6/1	2009/5/1
	4回目開放時の経過年数	23.0	23.8	23.0	21.1	21.4	24.4	25.5	24.6	25.3
	膨れ面積 (m^2)	74	6	10	4.7	0.5	0.5	277.96	2.85	21.3
	補修率 (%)	1.57	0.13	0.21	0.10	0.01	0.01	5.91	0.06	0.45
累積補修率 (%)	1.74	0.94	11.70	2.27	0.05	0.02	7.71	0.11	1.99	

タンク No.	A-20	A-21	A-26	A-27	A-39	A-47	A-56	A-57	A-58	
新規塗装	初期膜厚 (Min) μm	520	550	450	450	560	480	480	450	500
	初期膜厚 (Ave) μm	781	803	715	717	770	789	850	738	779
	初期塗装完了	83/10/17	83/10/17	83/10/17	83/10/19	84/08/11	84/09/10	83/07/22	83/07/18	83/06/08
1回目開放	第1回オイルイン 年月	83/11/26	83/11/09	83/11/30	83/12/08	85/07/06	85/03/27	83/09/01	83/09/01	83/09/01
	第1回目開放 年月	86/06/06	87/08/01	87/05/11	88/09/01	88/09/19	88/06/24	86/07/31	87/06/27	87/05/18
	膨れ・剥離面積 (m^2)	0	0	3	15	0	140	0	0	0
	補修率 (%)	0.00	0.00	0.57	0.32	0.00	3.19	0.00	0.00	0.00
2回目開放	第2回目開放 年月	90/10/13	92/08/07	92/07/16	93/09/30	93/09/09	93/05/06	91/05/20	93/06/04	92/06/24
	2回目開放時の経過年数	6.9	8.8	8.6	9.8	8.2	8.1	7.7	9.8	8.8
	膨れ面積 (m^2)	0	2.5	90	235	2	10	0	0	0
	補修率 (%)	0.00	0.05	1.91	5.00	0.04	0.21	0.00	0.00	0.00
3回目開放	第3回目開放 年月	97/06/30	2000/11/22	99/07/20	2001/6/20	2001/5/23	00/05/18	1999/6/14	2001/8/1	2000/8/1
	3回目開放時の経過年数	14	17	16	18	16	15	16	18	17
	膨れ面積 (m^2)	0.09	295	119	5.0	5.5	42	0	0.2	0.4
	補修率 (%)	0.00	6.28	3.02	0.11	0.33	0.89	0.00	0.01	0.01
4回目開放	第4回目開放 年月	2005/10/1	2009/9/1	2007/12/1	2009/10/1	2009/11/1	2008/8/1	2007/7/1	2009/8/1	2008/10/1
	4回目開放時の経過年数	21.9	25.8	24.0	25.8	24.3	23.4	23.8	25.9	25.1
	膨れ面積 (m^2)	72	278.8	190	23.1	1.06	0.33	1	3.86	0.2
	補修率 (%)	1.53	5.96	4.04	0.51	0.02	0.01	0.02	0.08	0.02
累積補修率 (%)	1.53	12.29	9.56	5.94	0.40	4.30	0.02	0.09	0.03	

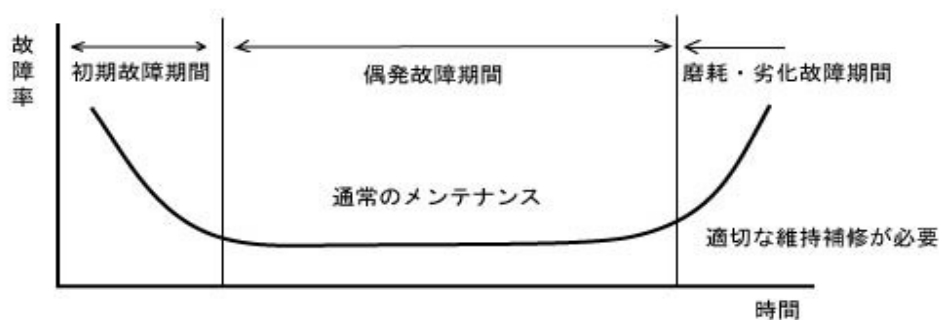
5.6.3 Making of weigh-in line

(1)40/20°C temperature inclination soaking examination result of the execution in the days this fiscal year and the past of the swelling generation by the durability limit that paid attention to the permeability of moisture to the paint film was summarized in Table 5.6.2.

表 5.6.2 40/20 温度勾配浸漬試験結果一覧 (B V樹脂GF 塗料)

	B V樹脂塗料 400 μ m	B V樹脂塗料 700 μ m	B V樹脂塗料 1000 μ m	(参考) B V樹脂/N V樹 脂塗料 400 μ m	外観観察頻 度
平成 13 年度 試験片 2 ヒース 浸漬期間 100 日	93 日以降 (以降 の観察未実施)	93 日以降 (以降 の観察未実施)	—	93 日以降 (以降の 観察未実施) 樹脂配合率不明	7 日目から 7 日ごと
平成 14 年度 試験片 2 ヒース 浸漬期間 151 日	75 日～97 日の 間 2 ヒース膨れ発生	111～130 の間 2 ヒース膨れ発生	—	75 日～97 日の間 樹脂配合率不明 2 ヒース膨れ発生	7 日目から 7 日ごと
平成 21 年度 試験片 1 ヒース 浸漬期間 179 日	75 日目の初回観 察日には既にふ くれていた。	75 日目の初回観 察日には既にふ くれていた。	141～147 日 の間	91～97 日の間 BV 樹脂 70%/NV 樹脂 30%	75 日目から 10 日ごと
平成 22 年度 試験片 3 ヒース 浸漬期間	51～55 日の間 56～58 日の間 51～55 日の間 平均 52～56 日	66～70 日の間 56～58 日の間 51～55 日の間 平均 58～61 日	—	80～85 日の間 66～70 日の間 59～65 日の間 平均 68～73 日 配合率は上と同じ	5 日目から 5 日ごと

The following can be considered from the result of 40/20°C temperature inclination soaking examination.

?Uneven to the soaking examination result every fiscal year is understood. Even if there is a possibility that the condition of the examination (mix of the temperature management, the surface-roughness, and paints at the maceration in detail) is not the same when 2002, 15 fiscal year, and 2009 and 22 fiscal year are compared, and the film thickness and the resin composition are the same, the generation days of the swelling cannot be simply compared. Moreover, there is a possibility that reproducibility is not obtained from the difference of the surface-roughness of the test piece at intervals of days of the external observation when 2009 fiscal year is compared with 22 fiscal year.

?The area of the swelling increases monotonously after generating the swelling though the test piece was produced in having arranged the construction environment (Figure 5.2.3) though the swelling has been generated by days different in each test piece. Figure 5.6.1 of this state. It is understood that it is thought that it arrived at the state that [ni] corresponds, and a constant durability limit exists in the GF coating.

?It is long like the one with thick film thickness and when the film thickness is thick, the performance of durability is steady to the durability limit of the paint film from the test outcome at current year because the swelling generation days are different according to the difference of the film thickness of the test piece.

?It is not confirmed in the paint film of 400μm in the film thickness though the difference of durability by the difference of the resin is confirmed in the paint film of

700µm in the film thickness in the result in 2009 fiscal year of 2002 fiscal year though the paint film of 400µm in the film thickness of BV resin/NV resin GF coating paints showed durability that is higher than the one of the same film thickness of BV resin GF coating paints in the result at current year. It is thought that the difference of durability by the difference of the resin doesn't necessarily appear stably from this in the paint film of 400µm in the film thickness.

The swelling generation days of each film thickness of 40/20°C temperature inclination soaking examination (a lot of BV plastic paint used in a real tank) that makes the working curve are summarized from the test outcome at current year in Table 5.6.3(mean value of three test pieces).

Table 5.6.3 Swelling generation days of each film thickness of 40/20°C temperature inclination soaking examination (BV resin GF paints)

表 5.6.3 40/20°C温度勾配浸漬試験の膜厚ごとのふくれ発生日数 (BV樹脂GF塗料)

	400 µ m	700 µ m
膨れ発生日数	52 日～56 日	58 日～61 日

Swelling generation days the 52nd. 58 of the 56th?The 61st

(2)Number of years elapsed for paint film that swelling is widely generated in real tank
 ?It is not thought that it has arrived from the admission of neither tear of the swelling nor damage, etc. and no generation of the corrosion thinning of the bottom board either at the state to exceed the durability limit completely as the entire paint film though the swelling has been somewhat generated if the average film thickness of about 700µm is secured from the paint film locale survey result of last year's real tank. It can be confirmed that there is durability for 26 years (above) when BV resin GF coating paints (average film thickness 700µm) are used at the normal temperature as results.

?However, ..generated swelling.. Figure 5.6.1 in opening during year 26. This figure though it is the one due to the defect of the [niokeru] happening by accident. Whether it is what caused with [ni] cannot be judged.

?In view of the situation of the site investigation, the durability limit of the paint film is exceeded though it has been used for 24 years by average film thickness 528µm in C tank by the site investigation at current year.

?In A tank by the site investigation at current year, the durability limit has not been exceeded though it uses for 14 years by average film thickness 517µm.

And, do? Whether construction that it drinks and the paint film of the tank suits the coating indicator is done, as the construction age, A tank is time with a constant finding for the construction technique of the coating in 1986 1996(1996)(1986)C tank though it is not clear.

A lot of things with a high repair rate come to be shown from the result of the survey of the repair history in BV resin GF coating of 250μm in the specification lowest film thickness when 20 years are exceeded.

It is thought that the value of 20 years as the life to film thickness 400μm of the coating indicator as of twining is reasonable values in a present finding.

The swelling generation year of each film thickness from the result of the survey of the paint film with a real tank where the working curve is made is summarized from the result in 2009 and 22 fiscal year in Table 5.6.4.

表 5.6.4 実タンクにおける塗膜の膨れ発生推定年数 (BV樹脂GFコーティング)

	400 μ m	700 μ m
膨れ発生推定年数	14 年以上 24 年未満	26 年以上の可能性

(3) Making of working curve

(1) 、 (2) Drink..result..for..provide..resin..coating..paint film..working curve..make..Figure..become.

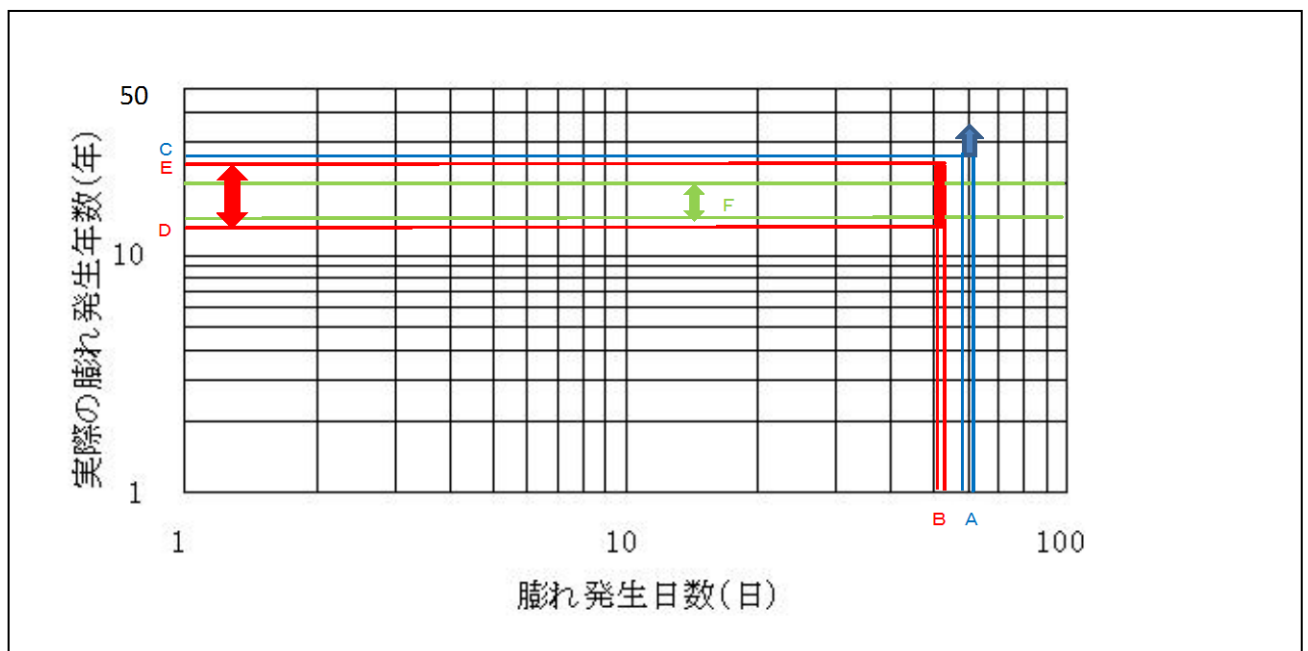

:The swelling occurrence time from the temperature inclination soaking examination result of 700 μm when you adopt the mean value of three examinations (58?61) in 2010 fiscal year

B:The swelling occurrence time from the temperature inclination soaking examination result of 400 μm when you adopt the mean value of three examinations (52?56) in 2010 fiscal year

C:The GF coating of about 700 μm considers the swelling of three local investigation results of 700 μm (852 μm in the average film thickness of average 485 μm of the lowest film thickness and the bottom plate, 912 μm in the average of the [anyura] board film thickness, and the specification film thickness: lowest and 430 μm and average 650 μm) to be a swelling due to the defect of happening by accident in 2009 fiscal year, and : when thinking that the life is expected for 26 years or more.

D:The GF coating of about 400 μm : from the result of local investigation tank A of 2010 fiscal year (393 μm in the lowest film thickness and average film thickness 517 μm) when thinking that the life can be expected for 14 years or more (However, it is uncertain whether construction that a paint film concerned followed the coating indicator was done).

E:The GF coating of about 400 μm : from the result of local investigation tank C of 2010 fiscal year (336 μm in the lowest film thickness and average film thickness 536 μm and 24 passage years years) when thinking that there is no life for 24 years (However, it is uncertain whether construction that a paint film concerned followed the coating indicator was done).

F:The life of GF constructed by specification minimum film thickness 250 μm (There is no film thickness record) from the repair history analysis result of the paint film of a private tank of 2010 fiscal year when thinking for 20 years from 15 years (However, it is uncertain whether construction that a paint film concerned followed the coating indicator was done)

図 5.6.2 ビスフェノール系ビニルエステル樹脂ガラスフレーク塗膜の検量線 (常温)

5.6.4 Consideration

?The working curve (Figure 5.6.2) that tried making at current year had width, and was not able to make a determinate working curve. It is one factor not to have obtained enough data for conditions of performance and the durability limit of the paint film of a real tank though this should obtain the data of the durability limit of the paint film of a real tank where the material and conditions of performance of the paint film of the accelerating test are almost the same to make the working curve with high accuracy.

?An equal execution management to the coating indicator was executed, and the average film thickness was able to confirm BV resin GF coating paint film of 700 μm was

healthy about 26 years. Moreover, the average film thickness is appreciable of the paint film of 700 μ m in the film thickness from the clarification of having an effect of controlling the penetration of moisture compared with the paint film of 400 μ m in the film thickness high, steady durability as a result of the soaking examination and when it stably has the life for about 26 years, the paint film of 700 μ m is appreciable.

?Whether the swelling had generated when 26 years passed was the one due to the defect of happening by accident or it was what had begun to be generated because the durability limit was received was not able to be judged. That is, information whether from it to years how many is not obtained though it is thought that the life is 26 years or more.

?When the swelling tore, it was clarified that the corrosion rating might become large depending on the environmental condition like the deterioration situation etc. of the paint film in the surrounding.

?The paint film was thought to be further progress of deterioration when the durability limit was exceeded from a monotonous increase of the area of the swelling after the swelling had been generated when soaking was examined.

????It is thought that it is appropriate to twine and to judge the life of BV resin GF coating paint film of the average of , film thickness 700 μ m level to be 26 clear years from results to present.

?The difference of durability by the difference of the resin doesn't necessarily appear stably in the paint film of 400 μ m in the film thickness though the difference of durability by the difference of the resin is confirmed about the difference of durability by the difference of the resin in the paint film of 700 μ m in the film thickness.

References cited

1)Japanese high-pressure power technological society: Durability study (investigation of results of coating) January, report and 2010 of tank bottom coating of land tank in 2009 fiscal year

5.7Examination concerning the life of inside coating of outdoor storage tank

It is possible the swelling the degradation phenomenon that has been actually actualized, and to influence a lot as this cause though the infiltration of moisture, the swelling by the solvent element, and the swelling by the acid element etc. and resolutions are thought as the deterioration factor of an inside coating. a moisture elementIt paid attention from the clarification of the corrosion rating's being likely

being likely to become large depending on the environmental condition when the swelling tore to the generation of the swelling and it examined it. The result is brought together as follows.

5.7.1 The life of paint film seen from results

When judging from statistics concerning a corrosion rating inside in the tank where BV resin GF coating was done, the third inspecting it it was clarified that inside corrosion had been found in a lot of tanks though it was not a coating that followed the coating indicator. Moreover, it is evaluated that the paint film has been used for 24 years by average film thickness $528\mu\text{m}$ as a result of the investigation of the tank where BV resin GF coating was done (construction in 1986) exceeds the durability limit in view of the deterioration situation though it is uncertain whether construction that suited the coating indicator was done. It was evaluated that the paint film had been used for 14 years by average film thickness $517\mu\text{m}$ (construction in 1996) was seen from the deterioration situation and the durability limit had not been exceeded. It doesn't change from the above-mentioned at the present life (20 years) to the paint film of the standard "Minimum film thickness $400\mu\text{m}$ ". The coating indicator is the one put out on September 1, 1994, only 16 years pass, and there is no data about the deterioration situation when the coating that suits an indicator concerned is used for 20 years or more.

5.7.2 Paint film that has durability that exceeds 20 years

If it was a paint film of average film thickness $700\mu\text{m}$ level, it was clarified that there was life for about 26 years from the examination to the foregoing paragraph. It was thought that the life of the paint film was influenced from a comprehensive viewpoint by the average film thickness if no homogeneity of the environment in tanks of the distribution of the sludge and moisture and the temperatures, etc. was considered, and was clarified also of receiving of the deterioration situation the influence of the film thickness from the result of the survey of the tank where durability had been exceeded. It is necessary to take account to the distribution of the film thickness to provide for the life long-term that exceeds 20 years from this. Figure 5.7.1 shows the example of the thickness distribution of the paint film with the life for about 26 years. These are the one constructed by the specification "Minimum film thickness $430\mu\text{m}$ or more and average film thickness $650\mu\text{m}$ or more". On the other hand, the average film thickness is not provided for, and the example of the film thickness of the paint film constructed by the specification "Minimum film thickness $400\mu\text{m}$ or more" is shown in Figure 5.7.2.



図 5.7.1 25 年以上の実績があるタンクのコーティングの膜厚分布の例 (3 基)



図 5.7.2 最低膜厚が 400 μ m 以上となるよう施工されたタンクのコーティングの膜厚分布の例 (3 基)

It is possible that the life of the paint film is influenced by a big film thickness (That is, it is thinner than the average more partial) to be distributed with the film thickness biased like the example in the right of Figure 5.7.2. Figure 5.7.3 shows the image of the distribution of the film thickness. The paint film (Figure 5.7.1) that was able to confirm the life for about 26 years has the thickness distribution like the left side of figure, and there is the one with the biased distribution from the consideration only of minimum film thickness shown as a specification in the tank in Figure 5.7.2 construction, too. Even if an extreme case is assumed and the average film thickness is the same as a left one of figure for the thickness distribution like the right side of Figure 5.7.3, the life must be different from the paint film with a left thickness distribution because a lot of parts where the film thickness is thin exist.

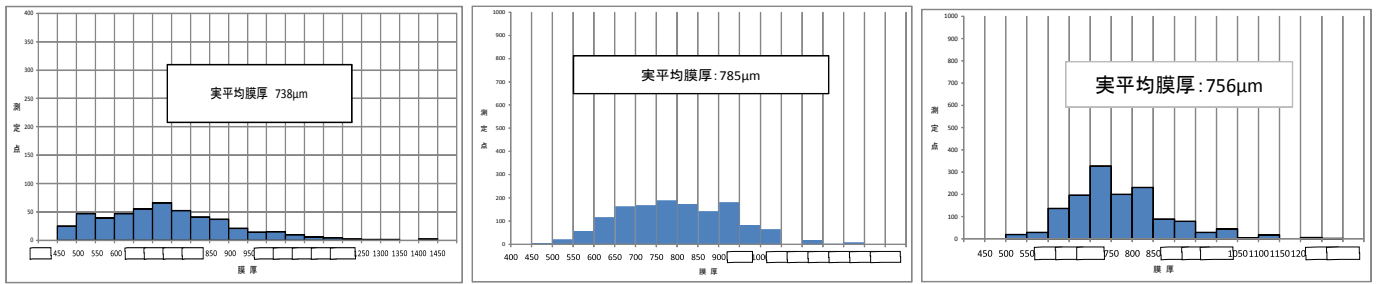

図 5.7.3 膜厚の分布のイメージ

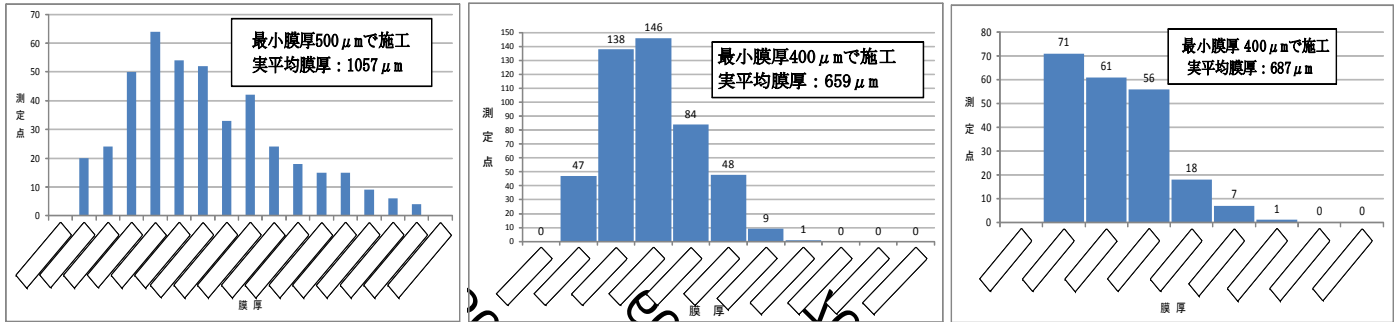
.7.5 Problem after this

In this examination, whether the swelling had generated in BV resin GF coating paint film that passed from construction 26 years was what generated by the defect of happening by accident or it was what had begun to be generated because the durability limit was received was not able to be judged. Moreover, because the working curve with high accuracy had not been obtained because it was uneven to the swelling generation in soaking examination day and the repair rate in a real tank, etc. , the life was examined based on results. The finding of the deterioration of the paint film in the tank is necessary to be difficult to say for an enough finding to have been accumulated, and to use the paint film for a long term about the durability limit of the coating that exceeds 20 years. It is possible to accumulate the result of the survey of the deterioration situation of the paint film in a real tank, and to advance the examination of a new management method like the evaluation of [yojumyou] of the coating that uses a new finding and the technology etc. for that.

This time, it was difficult to collect the data of the reasonable amount and accuracy though data that investigated the deterioration situation of the coating had been collected. Because it was clarified that the corrosion rating might become large according to the condition of a peripheral deterioration situation etc. if the flaking off part is caused in the paint film by any chance, it is necessary to manage the coating from the viewpoint of basic prevention of accidents appropriately besides the cycle extension. The coating that conditions of performance are not clear as described by 5.6.4 there, too and investigating the deterioration situation when it is opened to preserve it of the construction record (Only when opening it once every several years, it can know the deterioration situation of the coating) and recording are important. It is thought that it becomes possible to advance the examination of the prolongment of the coating at the life by assuming the accumulation of such data to be a radical. It is possible to construct a common data base like the search procedure and the description method of the paint film etc. as a concrete approach. Moreover, it is important to do in front of the oil Inn an appropriate check and repair from the idea of the healthy decrease factor of the damage of the paint film by the work when opening it besides a pure coating degradation etc. about the deterioration of the paint film.

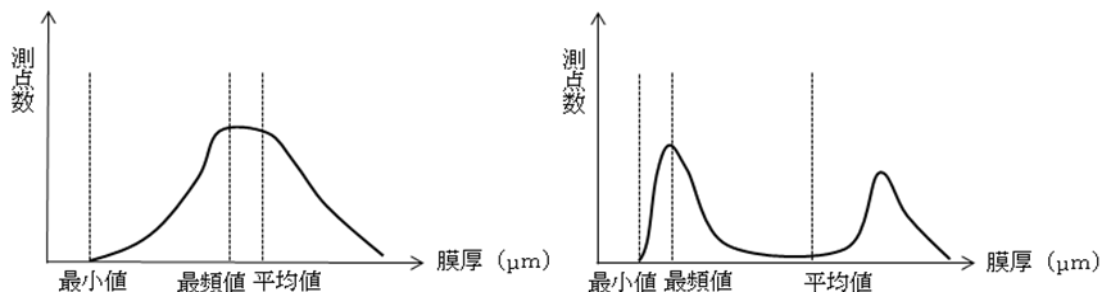
Chapter 6 Summary

The security inspection that lies outdoor tank reservoir * of 10,000 kiloliters or more in capacity set up after 1977 is executed for the board thickness of the tank bottom and the matter concerning the weld at intervals of eight years (The one on which the measures for security lectures is 10 years or 13 years). The examination done at this investigation study committee for the cycle of this inspection is brought together in the following.

It scratched for information about situations of the shut down inspection in the influence and foreign countries when the situation of the occurrence of the execution condition of the repair when inspecting it as an analysis of the current state and the accident and the dangerous article outflow accidents occurred in Chapter 2(Figure 6?1). Moreover, a constant finding was obtained about the corrosion of the board of the bottom of the tank though data concerning the corrosion of the board of the tank bottom was collecting analyzed, and the uncertainty remained of the restriction of the measurement density and the frequency of data (Figure 6?2).

- The main primary cause of outflow accident from tank bottom (deterioration factor of passing year)
- ・Thinning due to inside corrosion
- ・Thinning due to the back corrosion
- ・Weld deterioration
- Accident situation of the occurrence
- ・1974?22 outflow accidents will occur from the outdoor tank bottom of 10,000 kiloliters or more in capacity in 2010.
- ・Five outflow accidents occur from the tank bottom of 10,000 kiloliters or more in capacity because of the Miyagi-ken-oki Earthquake generated in 1978.
- Feature of outflow accident from bottom in large-scale tank
- ・The one that was a small-scale outflow might rapidly develop into the large-scale outflow accident first (France in Belgium in Sendai City in 1974 Toshioka Kurashiki City, Yamagata and 1978 and 2005 and 2007).



図6-1 タンク底部からの流出事故の状況 (左枠囲い) とタンクの劣化の模式図 (右)



- A left the above chart is showing of the board thickness of the tank bottom. A blue part is a part where corrosion doesn't progress, and a yellow part in a yellow frame is a part where the board has thinned due to the back corrosion.
- A right the above picture is showing of the result of a measurement of the thickness of the bottom plate in a left tank (The measurement point is almost proportional to the area) by the measurement point of each board thickness. The majority of board thickness are in the range from 11.3 to 12.3 millimeters, and the part that has decreased within the range from 7.0 to 9.0 millimeters in board thickness exists, too.
- Corrosion often advances locally on the back of the tank bottom like this example.

図6-2 タンク底部の板厚分布（左）及び板厚の測定頻度（右）

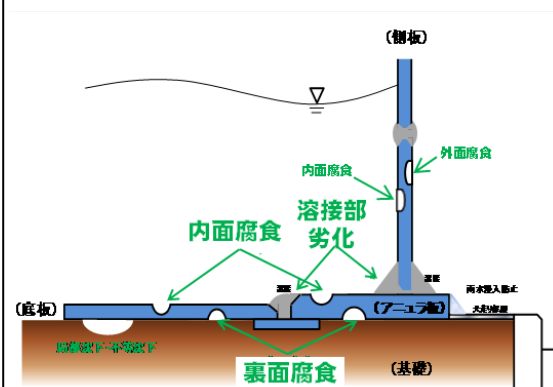
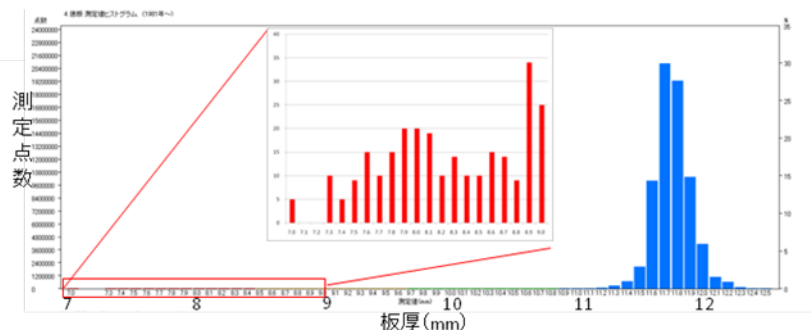
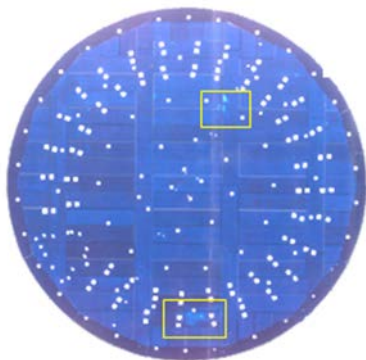
In Chapter 3, the influence given to safety when the fundamental period of the security inspection was extended for eight years was evaluated. The number of cases where the penetration hole was caused by the number of cases and the back corrosion where the penetration hole was caused by inside corrosion was forecast when assuming that the inspection cycle was extended by using the data when inspecting it in the past (Table 6?1). As a result, it was said that a present fundamental period was an expectation of reasonable safety, and it was not suitable to extend the fundamental period with a present inspection method maintained because a dangerous outflow rose greatly. Because the technology that did the fixed quantity evaluation had not established it, these were not evaluated though the accident from the tank bottom included the accident due to deterioration in the weld and the accident at the earthquake due to the earthquake resistance decrease besides the formation of the penetration hole due to corrosion.

表 6 - 1 腐食により貫通事故が発生すると推定されるタンク基数

開放までの年数	内面腐食による貫通件数 (累計)	裏面腐食による貫通件数 (累計)	重複しているタンク数 (累計)	合計件数
8 以下	1	3	1	3
～9	5	6	1	10
～10	5	7	1	11
～11	11	9	2	18
～12	15	10	2	23
～13	21	12	3	30
～14	23	14	3	34
～15	29	15	3	41
～16	33	17	4	46

Chapter 4 examined whether the inspection cycle was able to be extended without ruining safety when the continuous board thickness metrology to the tank bottom was used. The back corrosion speed when the corrosion situation of the board of the tank bottom is measured by the continuous board thickness metrology as a result of evaluating the uncertainty of the inclusion in the corrosion rating etc. is below constancy. In the tank where it met requirements such as the construction of the coating that fulfilled certain conditions or very the inside corrosion speeds small in contents without the causticity, the inspection cycle was able to be extended until constant years (15 years at most)(Table 6?2).

In Chapter 5, the collection analysis of the repair history data of the indoor examination, the site investigation, and the coating is done for the life of the coating that prevents corrosion in the tank. The one to meet a constant film thickness requirement was evaluated about the life when the glass flakes coating that used the material from which it was lectured by constant conditions of performance and the quality was confirmed maintained the inside corrosion prevention function referring to results in a real tank (Table 6?3) as 26 years.

表 6-2 連続板厚測定法を活用した保安検査周期の決定方法

項目		開放周期延長の要件	
実施する検査		連続板厚測定法を実施（機械測定が難しい部位については、手動で詳細測定を実施）。	
次回保安検査までの期間の求め方		$\text{次回保安検査までの年} = (\text{前回の保安検査時の最小板厚} - \text{管理板厚} *) \div (\text{腐食速度})$ *管理板厚：告示第4条の17の最小厚さから腐食しろ3mmを減じた値	
腐食速度の求め方	底板	○コーティングを施工したタンクの場合 連続板厚測定法の測定結果から算出された裏面腐食速度の最大値	○コーティングを施工していないタンクの場合 連続板厚測定法の測定結果から算出された裏面腐食速度の最大値と内面腐食箇所の腐食速度の最大値（当該箇所に裏面腐食が存在する場合は両方を考慮した腐食速度）のいずれか大なる値
	アニュラ板		
期間の上限		15年	
内面腐食に関する事項	底板	○コーティングを施工したタンクの場合 コーティング指針に基づき施工されたコーティング、若しくはそれと同等程度の性能を有しているもので、内面腐食防止効果が維持されているもの。	○コーティングを施工していないタンクの場合 ・腐食性の非常に低い内容物を貯蔵している（直近2回の開放において内面腐食速度が0.1mm/年以下であること）。 ・水分管理（固定屋根形式に限る。）が適切になされ、腐食環境に変化がないこと。
	アニュラ板		
裏面腐食に関する事項	底板	連続板厚測定法による測定データに基づく、前回の直近の検査から前回の保安検査までの間の腐食速度が0.2mm/年以下であること。	
	アニュラ板		
腐食環境に関する事項		危険物が加温貯蔵されていないこと。	
		腐食の発生に著しい影響を及ぼす貯蔵条件、構造の変更を行わないこと。	
タンク全体の維持管理		タンクに構造上の影響を与えるおそれのある補修又は変形がないこと。	
		著しい不等沈下がないこと。	
		地盤が十分な支持力を有するとともに沈下に対し十分な安全性を有していること。	
		特定屋外貯蔵タンクの維持管理体制が適切であること。	

表 6-3 ガラスフレックコーティングの耐用年数

ビスフェノール系ビニルエステル樹脂ガラスフレックコーティング塗膜及びノボラック系ビニルエステル樹脂ガラスフレックコーティング塗膜	最小膜厚 400 μm 以上	20年
	最小膜厚 400 μm 以上かつ平均膜厚 700 μm 以上であって、膜厚分布に著しい偏りのないもの	26年

Future tasks

As for deterioration in the tank bottom, it is a problem to obtain data only at time of open of every several, and for changing the board might performed without investigating when corrosion is remarkable, and not to obtain data enough. It is important to examine the requirement for the extension of the ideal way of the security inspection and the cycle again when it tries to accumulate data investigating deterioration in corrosion of the board of the tank bottom, weld deterioration, and the coating etc. when opening it, and an enough finding is obtained about the deterioration

factor of these bottoms in the future in a related office.

About other parts (shroud and attached equipment, etc.), securing safety is necessary, and promotion of independent security is expected though the board thickness of the bottom that inspected security and the examination of the matter concerning the weld were done at this investigation study committee.